Front-Panel Reference

HP 54121T Digitizing Oscilloscope
Consisting of: HP 54120B
HP 54121A



© Copyright Hewlett-Packard Company 1989

Publication 54121-90906

Printed in the U.S.A. July 1989

Herstellerbescheinigung

Hiermit wird bescheinigt, dass das Gerät/System HP 54121T in Übereinstimmung mit den Bestimmungen von Postverfügung 1046/84 funkentstört ist.

Der Deutschen Bundespost wurde das Inverkehrbringen dieses Gerätes/Systems angezeigt und die Berechtigung zur Überprüfung der Serie auf Einhaltung der Bestimmungen eingeräumt.

Zusatzinformation für Mess- und Testgeräte

Werden Mess- und Testgeräte mit ungeschirmten Kabeln und/oder in offenen Messaufbauten verwendet, so ist vom Betreiber sicherzustellen, dass die Funkentstörbestimmungen unter Betriebsbedingungen an seiner Grundstücksgrenze eingehalten werden.

Manufacturer's declaration

This is to certify that this product HP 54121T meets the radio frequency interference requirements of directive 1046/84. The German Bundespost has been notified that this equipment was put into circulation and was granted the right to check the product type for compliance with these requirements.

Additional Information for Test and Measurement Equipment

Note: If test and measurement equipment is operated with unshielded cables and/or used for measurements on open set-ups, the user must insure that under these operating conditions, the radio frequency interference limits are met at the border of his premises.



GEWERBEAUFSICHTSAMT STUTTGART

- Zentrale Stelle für Sicherheitstechnik und Vorschriftenwesen in Baden-Württemberg -

Gewerbeaufsichtsamt · Jägerstr. 22 · Postfach 703 · 7000 Stuttgart 1

Stuttgart, den 16.01.1986

Fernsprecher

(07 11) 205 01 (Behördenzentrum)

Durchwahl 2050- 4796

Aktenzeichen: Z 5108/HP/Ws/Hh
(Bitte bei Antwort angeben)

Firma
Hewlett Packard GmbH
Herrenberger Str. 110/130

7030 Böblingen

Zulassungsschein Nr. BW/218/86/R8

Gemäß § 9 der Röntgenverordnung vom 01.03.1973 (BGBl. I S. 173) wird die Zulassung der Bauart durch den Bauartzulassungsbescheid vom 16.01.1986 mit Aktenzeichen Z 5108/HP/Ws/Hh für den nachfolgend aufgeführten Störstrahler bescheinigt:

Gegenstand	: Digital-Oszilloskop
Firmenbezeichnung	: HP Typ 54110D
Bildröhre	: Sony Typ M23 JHU 15X
Hersteller	: Hewlett-Packard 1900 Garden of the Gods Road Colorado Springs Colorado 80907, USA
Betriebsbedingungen	: Hochspannung: max. 22,3 kV Strahlstrom: max. 0,4 mA
Zulassungskennzeichen	: BW/218/86/R8

Die Bauartzulassung ist befristet bis 16.01.1996.

Für den Strahlenschutz wesentliche Merkmale

1. Die Art und Qualität der Bildröhre,
2. die der Hochspannungserzeugung und -stabilisierung dienenden Bauelemente.

Auflagen:

1. Die Geräte sind bezüglich der für den Strahlenschutz wesentlichen Merkmale entsprechend den vorgestellten und geprüften Mustern und Antragsunterlagen herzustellen.
2. Die Geräte sind einer Stückprüfung daraufhin zu unterziehen, ob sie bezüglich der für den Strahlenschutz wesentlichen Merkmale der Bauartzulassung entsprechen.

Die Prüfung muß umfassen:

- a) Kontrolle der Hochspannung an jedem einzelnen Gerät,
 - b) Messung und Dosisleistung nach Festlegung im Bauartzulassungsbescheid.
3. Die Herstellung und die Stückprüfung sind durch den von der Zulassungsbehörde bestimmten Sachverständigen überwachen zu lassen.
 4. Die Geräte sind deutlich sichtbar und dauerhaft mit dem Kennzeichen

BW/218/86/R8

zu versehen sowie mit einem Hinweis folgenden Mindestinhalts:

"Die in diesem Gerät entstehende Röntgenstrahlung ist ausreichend abgeschirmt.
Beschleunigungsspannung maximal 22,3 kV."

Hinweis für den Benutzer des Geräts:

Unsachgemäße Eingriffe, insbesondere Verändern der Hochspannung oder Auswechseln der Bildröhre können dazu führen, daß Röntgenstrahlung in erheblicher Stärke auftritt. Ein so verändertes Gerät entspricht nicht mehr dieser Zulassung und darf infolgedessen nicht mehr betrieben werden.

Reutter

Reutter



Dieses Gerät wurde nach den Auflagen der Zulassungsbehörde einer Stückprüfung unterzogen und entspricht in den für den Strahlenschutz wesentlichen Merkmalen der Bauartzulassung. Die Beschleunigungsspannung beträgt maximal 22,3 kV.

Hewlett-Packard
1900 Garden of the Gods Road
Colorado Springs
Colorado 80907, USA



GEWERBEAUF SICHTSAMT STUTTGART

- Zentrale Stelle für Sicherheitstechnik und Vorschriftenwesen in Baden-Württemberg -

Gewerbeaufsichtsamt - Meyerstr. 19 - Postfach 703 - 7000 Stuttgart

Hewlett-Packard GmbH
Herrenberger Straße 110

7030 Böblingen

Stuttgart, den 02.06.1986

Fernsprecher:

107 111 805 01 (Behördenzentrum)

Durchwahl 8056 - 4798

Aktensachen: Z 5108/Hewlett-
(Bitte bei Antwort angeben)

Packard/MS/Vg

Betr.: Durchführung der Röntgenverordnung (RBV)
hier: Bauartzulassung gem. § 7 Abs. 2 RBV

Bezug: Ihr Antrag vom 22.05.1986; PSD U5-ab

Nachtrag 1

zum Zulassungsschein Nr. BW/218/86/Rö

Aufgrund des § 7 Abs. 2 der Röntgenverordnung vom 1.3.1973 (BGBl. I S. 173) wird die der Firma Hewlett-Packard GmbH, Herrenberger Straße 110, 7030 Böblingen, erteilte Zulassung Nr. BW/218/86/Rö vom 16.01.1986 wie folgt erweitert:

Gegenstand:	Digital-Oszilloskop
Firmenbezeichnung:	HP Typ 54 111 D HP Typ 54 112 D HP Typ 54 120 A
Bauartunterlagen:	Service Manuals Nr. 54 111 - 90 902 vom 21.04.86 Nr. 54 112 - 90 902 vom 24.04.86 Nr. 54 120 - 90 902 vom 26.04.86

Die für den Strahlenschutz wesentlichen Merkmale entsprechen der bereits zugelassenen Ausführung.

Typenbezeichnung der Bildröhre, Auflagen, Hinweise und Befristung ergeben sich aus dem Zulassungsschein Nr. BW/218/86/Rö vom 16.01.1986.

Dieser Nachtrag gilt nur im Zusammenhang mit dem vollständigen Text des o.g. Zulassungsscheins.

Reutter



Dieses Gerät wurde nach den Auflagen der Zulassungsbehörde einer Stückprüfung unterzogen und entspricht in den für den Strahlenschutz wesentlichen Merkmalen der Bauartzulassung. Die Beschleunigungsspannung beträgt maximal 22,3 kV.

Hewlett-Packard
1900 Garden of the Gods Road
Colorado Springs
Colorado 80907, USA

X-RAY RADIATION NOTICE

ACHTUNG

Model 54111D/54112D/54120A

WARNING

Während des Betriebs erzeugt dieses Gerät Röntgenstrahlung. Das Gerät ist so abgeschirmt, daß die Dosisleistung weniger als 36 $\mu\text{A}/\text{kg}$ (0,5 mR/h) in 5cm Abstand von der Oberfläche der Kathodenstrahlröhre beträgt. Somit sind die Sicherheitsbestimmungen verschiedener Länder, u.A. der deutschen Röntgenverordnung eingehalten.

Die Stärke der Röntgenstrahlung hängt im Wesentlichen von der Bauart der Kathodenstrahlröhre ab sowie von den Spannungen, welche an dieser anliegen. Um einen sicheren Betrieb zu gewährleisten, dürfen die Einstellungen des Niederspannungs- und Hochspannungsnetzteils nur nach der Anleitung in Kapitel Einstellvorschriften des Service Handbuchs vorgenommen werden.

Die Kathodenstrahlröhre darf nur durch die gleiche Type ersetzt werden. (Siehe Kapitel Ersatzteile für HP-Teilenummern.)

Das Gerät ist in Deutschland zugelassen unter

der Nummer: BW/218/86/ROE

When operating, this instrument emits x-rays; however, it is well shielded and meets safety and health requirements of various countries, such as the X-ray Radiation Act of Germany.

Radiation emitted by this instrument is less than 0.5 mR/hr at a distance of five (5) centimeters from the surface of the cathode-ray tube. The x-ray radiation primarily depends on the characteristics of the cathode-ray tube and its associated low-voltage and high-voltage circuitry. To ensure safe operation of the instrument, adjust both the low-voltage and high-voltage power supplies as outlined in the Adjustments Section of the Service Manual.

Replace the cathode-ray tube with an identical CRT only. Refer to the Replacement Parts Section for proper HP part number.

Number of German License: BW/218/86/ROE

Product Warranty

This Hewlett-Packard product has a warranty against defects in material and workmanship for a period of 1 year from date of shipment. During warranty period, Hewlett-Packard Company will, at its option, either repair or replace products that prove to be defective.

For warranty service or repair, this product must be returned to a service facility designated by Hewlett-Packard. However, warranty service for products installed by Hewlett-Packard and certain other products designated by Hewlett-Packard will be performed at Buyer's facility at no charge within the Hewlett-Packard service travel area. Outside Hewlett-Packard service travel areas, warranty service will be performed at Buyer's facility only upon Hewlett-Packard's prior agreement and Buyer shall pay Hewlett-Packard's round trip travel expenses.

For products returned to Hewlett-Packard for warranty service, the Buyer shall prepay shipping charges to Hewlett-Packard and Hewlett-Packard shall pay shipping charges to return the product to the Buyer. However, the Buyer shall pay all shipping charges, duties, and taxes for products returned to Hewlett-Packard from another country.

Hewlett-Packard warrants that its software and firmware designated by Hewlett-Packard for use with an instrument will execute its programming instructions when properly installed on that instrument.

Hewlett-Packard does not warrant that the operation of the instrument, software, or firmware will be uninterrupted or error-free.

Limitation of Warranty

The foregoing warranty shall not apply to defects resulting from improper or inadequate maintenance by the Buyer, Buyer-supplied software or interfacing, unauthorized modification or misuse, operation outside of the environmental specifications for the product, or improper site preparation or maintenance.

NO OTHER WARRANTY IS EXPRESSED OR IMPLIED. HEWLETT-PACKARD SPECIFICALLY DISCLAIMS THE IMPLIED WARRANTIES OF MERCHANTABILITY AND FITNESS FOR A PARTICULAR PURPOSE.

Exclusive Remedies

THE REMEDIES PROVIDED HEREIN ARE BUYER'S SOLE AND EXCLUSIVE REMEDIES. HEWLETT-PACKARD SHALL NOT BE LIABLE FOR ANY DIRECT, INDIRECT, SPECIAL, INCIDENTAL, OR CONSEQUENTIAL DAMAGES, WHETHER BASED ON CONTRACT, TORT, OR ANY OTHER LEGAL THEORY.

Assistance

Product maintenance agreements and other customer assistance agreements are available for Hewlett-Packard products.

For assistance, contact your nearest Hewlett-Packard Sales and Service Office. Addresses are provided at the back of this operating note.

Certification

Hewlett-Packard Company certifies that this product met its published specifications at the time of shipment from the factory. Hewlett-Packard further certifies that its calibration measurements are traceable to the United States National Bureau of Standards, to the extent allowed by the Bureau's calibration facility, and to the calibration facilities of other International Standards Organization members.

Safety

This product has been designed and tested according to International Safety Requirements. To ensure safe operation and to keep the product safe, the information, cautions, and warnings in this operating note must be heeded.

Printing History

New editions are complete revisions of the manual. Update packages, which are issued between editions, contain additional and replacement pages to be merged into the manual by the customer. The dates on the title page change only when a new edition is published.

A software and/or firmware code may be printed before the date; this indicates the version level of the software and/or firmware of this product at the time of the manual or update was issued. Many product updates and fixes do not require manual changes and, conversely, manual corrections may be done without accompanying product changes. Therefore, do not expect a one to one correspondence between product updates and manual updates.

Edition 1

July 1989

54121-90906

List of Effective Pages

The List of Effective Pages gives the date of the current edition and of any pages changed in updates to that edition. Within the manual, any page changed since the last edition is indicated by printing the date the changes were made on the bottom of the page. If an update is incorporated when a new edition of the manual is printed, the change dates are removed from the bottom of the pages and the new edition date is listed in Printing History and on the title page.

Pages	Effective Date
all	July 1989

Contents

Chapter 1

Introducing the HP 54121T Digitizing Oscilloscope

- 1-1 Introduction
 - 1-1 The HP 54121T's Features
 - 1-2 How to Use This Manual
-

Chapter 2

Basic Setup

- 2-1 Chapter Contents
 - 2-2 Operating Environment
 - 2-2 Avoiding Damage by Electrostatic Discharge
 - 2-3 Power Requirements
 - 2-3 Applying Power
 - 2-6 Initial Color Display Setup
 - 2-7 List of Accessories
-

Chapter 3

Making Measurements

- 3-1 Chapter Contents
- 3-1 Overview
- 3-1 Acquiring a Waveform
- 3-4 Making a Voltage Measurement
- 3-4 Making a Time Measurement
- 3-5 Saving a Waveform
- 3-6 Printing or Plotting a Waveform
- 3-7 Adding and Subtracting Waveforms
- 3-8 Inverting a Waveform
- 3-8 Making a Pulse Measurement
- 3-9 Making a TDR Measurement
- 3-10 Measuring the Distribution of a Waveform

Chapter 4

Front-Panel Overview

- 4-1 Chapter Contents
- 4-1 Front-Panel Organization
- 4-1 System Control Keys
 - 4-2 Clear Display Key
 - 4-3 Run Key
 - 4-3 Stop Key
 - 4-3 Save Setup and Recall Setup Key
 - 4-4 Local Key
 - 4-5 Autoscale Key
- 4-6 Entry Devices
- 4-7 Menu and Function Selection Softkeys
- 4-9 Color

Chapter 5

Channels Menu

- 5-1 Chapter Contents
- 5-1 Overview
- 5-2 Channel Select Key
- 5-2 Display On/Off Key
- 5-2 Volts/Div Key
- 5-3 Offset Key
- 5-3 Probe Atten Key

Chapter 6

Timebase Menu

- 6-1 Chapter Contents
- 6-1 Overview
- 6-2 Time/Div Key
- 6-2 Delay Key
- 6-2 Delay Reference Key
- 6-3 Freerun Trg'd Sweep Key
- 6-5 Freerun Rate Key

Chapter 7

	Trigger Menu
7-1	Chapter Contents
7-1	Overview
7-2	Trigger Level Key
7-2	Slope Key
7-2	Probe Atten Key
7-3	HF Sensitivity Key
7-3	HF Reject Key

Chapter 8

	Display Menu
8-1	Chapter Contents
8-1	Overview
8-2	Display Mode Key
8-4	Bandwidth Key
8-5	Screen key
8-6	Graticule Key
8-6	Infinite Persistence Exercise
8-6	Initial Instrument Setup
8-9	Averaged Display Mode Exercise
8-10	Initial Instrument Setup

Chapter 9

	Waveform Save Menu
9-1	Chapter Contents
9-1	Overview
9-2	Memory Selection
9-3	Pixel Memories
9-4	Waveform Memories
9-5	Display Key
9-5	Source for Store Key
9-6	Store Key

Chapter 10

Delta V Menu

- 10-1 Chapter Contents
 - 10-1 Overview
 - 10-2 Voltage Markers
 - 10-4 Preset Levels Key
 - 10-5 Auto Level Set Key
 - 10-6 Voltage Marker Exercise
 - 10-7 Initial Instrument Setup
 - 10-9 Source-to-Source Voltage Measurement Exercise
 - 10-10 Initial Instrument Setup
-

Chapter 11

Delta t Menu

- 11-1 Chapter Contents
 - 11-1 Overview
 - 11-2 Start and Stop Markers
 - 11-3 Start and Stop On Edge Keys
 - 11-5 Precise Edge Find Key
 - 11-6 Time-Interval Measurement Exercise
 - 11-7 Initial Instrument Setup
 - 11-9 Source-to-Source Time-Interval Exercise
 - 11-11 Initial Instrument Setup
-

Chapter 12

Waveform Math Menu

- 12-1 Chapter Contents
- 12-1 Overview
- 12-3 Function Select Key
- 12-3 Display On/Off Key
- 12-3 First Operand Key
- 12-3 Operation Select Key
- 12-4 Second Operand Key
- 12-4 Display Scaling Key
- 12-5 Waveform Math Exercise
- 12-6 Initial Instrument Setup
- 12-8 Using the Only Operator

Chapter 13

Measure Menu

- 13-1 Chapter Contents
 - 13-1 Overview
 - 13-2 Measure Key
 - 13-3 Precision Key
 - 13-4 All Key
-

Chapter 14

Network Menu

- 14-1 Chapter Contents
- 14-2 Overview
- 14-4 Cal Submenu
 - 14-6 Reflect Channel Is Key
 - 14-7 Using an External Pulse for TDR
 - 14-8 Using an External Attenuator for TDR
 - 14-8 Reflect Cal Key
 - 14-11 Trans Cal Key
 - 14-12 Velocity/Dielectric Constant Key
 - 14-16 Preset Reflect Channel Key
- 14-17 Reflect Submenu
 - 14-18 Step & Channel 1/3 Key
 - 14-18 Normalize Risetime Key
 - 14-19 Normalize to Mem 1 Key
 - 14-19 Cursor Key
 - 14-20 Min & Max Reflect Key
- 14-21 Reflect (TDR) Exercise
 - 14-21 Initial Instrument Setup
 - 14-25 Normalizing Exercise
 - 14-25 Initial Instrument Setup
- 14-29 Trans Submenu
 - 14-30 Step & Chan 4 Key
 - 14-31 Normalized Risetime Key
 - 14-31 Normalize to Mem 2 Key
 - 14-32 Cursor Key
 - 14-32 Prop Delay and Gain Key
- 14-32 Transmission (TDT) Exercise
 - 14-33 Initial Instrument Setup
 - 14-36 Using an External Pulse for TDT

Chapter 15

Histogram Menu

- 15-1 Chapter Contents
- 15-1 Histogram Menu
- 15-2 Overview
- 15-5 Window Submenu
- 15-6 Source Is Chan 1/2/3/4 Key
- 15-6 Time/Voltage Histogram Key
- 15-6 Window Marker 1 and 2 Keys
- 15-7 Acquire Submenu
- 15-8 Number of Samples Key
- 15-8 Display On/Off Key
- 15-9 Start Acquiring Key
- 15-9 Stop Acquiring Key
- 15-10 Results Submenu
- 15-11 Upper and Lower Distribution Limit Keys
- 15-11 0%-100% Set At Limits Key
- 15-12 Mean Key
- 15-12 Sigma Key
- 15-13 Histogram Exercise
- 15-13 Initial Setup for HP 54121T
- 15-18 Time Histogram

Chapter 16

Print Menu

- 16-1 Chapter Contents
- 16-1 Overview
- 16-3 Setting Up the HP 54121T for Printing
- 16-4 Print Menu Options

Chapter 17

Plot Menu

- 17-1 Chapter Contents
- 17-1 Overview
- 17-3 Setting Up the HP 54121T for Plotting
- 17-4 Plot Menu Options
- 17-4 Auto Pen Key
- 17-5 Pen Speed Key

Chapter 18

Utility Menu

- 18-1 Chapter Contents
 - 18-1 Overview
 - 18-3 Cal Menu
 - 18-4 Channel Vertical Cal Key
 - 18-5 Channel Skew Cal Key
 - 18-10 HP-IB Menu
 - 18-11 EOI Key
 - 18-11 Color Menu
 - 18-12 Color Field Key
 - 18-13 Hue Key
 - 18-13 Saturation Key
 - 18-13 Luminosity Key
 - 18-13 Default Setting Key
-

Chapter 19

Specifications and Operating Characteristics

- 19-1 Chapter Contents
- 19-2 Specifications
- 19-7 Operating Characteristics
 - 19-7 Channels (Vertical)
 - 19-7 Timebase (Horizontal)
- 19-8 Trigger
- 19-8 Display
- 19-9 Programmability
- 19-10 Measurement Aids
- 19-11 Network
- 19-14 Histograms
- 19-15 Setup Aids
- 19-15 Documentation Aids
- 19-15 Digitizer
- 19-16 General Characteristics
 - 19-16 Environmental Conditions
 - 19-17 Power Requirements
 - 19-17 Weight
 - 19-17 Dimensions

Appendix A **Errors, Messages, and Prompts**

Appendix B **Handling and Care of the Precision Connectors**

- B-1 3.5 Connector Care
- B-1 Connector Wear
- B-1 Operator Skill
- B-2 Device Specifications
- B-2 SMA Inspect
- B-2 Alignment
- B-4 Accuracy Considerations
- B-5 Handling Precision 3.5mm Connectors
- B-6 Visual Inspection and Cleaning
- B-6 Visual Inspection
- B-7 Cleaning
- B-8 Mechanical Inspection
- B-8 Center Conductor
- B-11 Outer Conductor
- B-14 Connecting the Devices
- B-15 Counter-Rotation Technique

Appendix C **TDR Fundamentals**

Appendix D **Improving Measurement Accuracy of Time Domain Network Analysis**

Appendix E **Transmission Line Theory**

Index

Introducing the HP 54121T Digitizing Oscilloscope

1

Introduction

The Hewlett-Packard 54121T Digitizing Oscilloscope provides up to 20 GHz bandwidth, full HP-IB programmability, and powerful features for a wide range of applications.

Not only does the HP 54121T allow you to accept signals from four different sources, but it has extensive features that make it useful for network analysis, waveform statistics, and as a high-speed extremely accurate oscilloscope.

The HP 54121T's Key Features

The HP 54121T's key features include:

- up to 20 GHz bandwidth in the averaged and persistence modes
- TDR capability
- waveform histogram and statistical data
- 10 ps time interval accuracy
- four waveform memories and two pixel memories
- 0.25 ps time interval resolution
- 10 ps/div horizontal scale factor
- 0.4% vertical accuracy in the averaged mode
- 32 μ V resolution in the averaged mode
- 1 mV/div vertical sensitivity
- autoscale
- automatic waveform measurements
- waveform math
- 10 front-panel setup save and recall registers
- waveform normalization capabilities
- functional color display
- instant hardcopy output
- full programmability over the HP-IB
- IEEE 488.2 programming compatibility

How to Use This Manual

This manual is the most complete source of information for the front-panel operation of the HP 54121T. It contains much information that is not included in the Getting Started Guide, and it repeats important information presented in that manual, so that you have one source of front-panel information once you are familiar with the instrument.

If you have not yet read the Getting Started Guide, you may want to do so at this time. The Getting Started Guide contains examples on how to make basic oscilloscope measurements, statistical measurements, and reflection (TDR) and transmission (TDT) measurements.

The HP 54121T has two major components: the HP 54120B Digitizing Oscilloscope Mainframe and the HP 54121A Four Channel Test Set. Throughout this manual when the model number HP 54121T is used, it will include the HP 54120B and the HP 54121A. The mainframe will be referred to as the HP 54120B and the test set as the HP 54121A.

Basic Setup

2

Chapter Contents

- the power requirements, operating environment, and initial color display setup of the HP 54121T
- how to avoid damaging the instrument with electrostatic discharge
- a list of accessories provided with the instrument
- a list of available accessories

WARNING

It is important that you provide the correct power source and operating environment for this instrument. Failure to do so can seriously damage the instrument and may cause a lethal electrical shock.

Operating Environment

CAUTION

Ensure that the instrument has adequate clearance on all surfaces so that it has sufficient air flow for cooling. Do not block any of the vent holes or the air inlet for the fans.

The operating environment must be maintained within the following parameters:

Temperature	15 ° C to 35° C (59 ° F to 95° F)
Humidity	90% up to 35° C (95° F)
Altitude	4572 metres (15,000 feet)

Protect the instrument from temperature extremes that could cause condensation in the instrument.

Avoiding Damage by Electrostatic Discharge

Appropriate precautions must be taken to limit the possibility of damaging the inputs of the HP 54121A and the device under test (DUT) with electrostatic discharge (ESD).

The inputs of the HP 54121A use gallium arsenide technology. In order to give you the best possible performance, protective circuitry has been omitted from these inputs. To compensate for this, certain procedures should be used when operating this oscilloscope.

ESD protection procedures include:

- ensuring that the oscilloscope chassis is properly grounded with a grounded power cord
- installing the antistatic mat (provided) under the HP 54121A Test Set if it is separated from the HP 54120B
- wearing the anti-static mat wrist strap when operating the oscilloscope
- discharging all cables before you connect them to the oscilloscope
 - use a short or 50 Ω termination to short the center conductor to the shield
- leaving SMA shorts on all unused oscilloscope inputs

Note

Complete installation and user instructions for the antistatic pad and wrist strap are included with the antistatic kit.

Power Requirements

The HP 54121T requires a power source of 115 or 230 Vac + 15% – 25%; 48 – 66 Hz single phase. Power consumption is approximately 200 watts maximum or 380 VA maximum.

CAUTION

Before connecting this instrument to the ac power source make sure the line select switch on the rear panel of the instrument is set to the correct position. You can use a screwdriver to change the position of this switch. If this switch is set incorrectly, serious damage to the instrument is likely.

Applying Power

Before applying power, the wide interface cable must be connected between the mainframe's interface port and the test set's interface port. Ensure the dots on the connector and the interface cable are aligned. Refer to figure 2-1. If the interface cable has not already been connected, you should do so now. Use a small flat blade screwdriver to fasten the interface cable to the mainframe and the test set.

Use the connector savers (APC 3.5 f-f adapters) provided with the instrument to protect the channel input connectors from excessive wear.

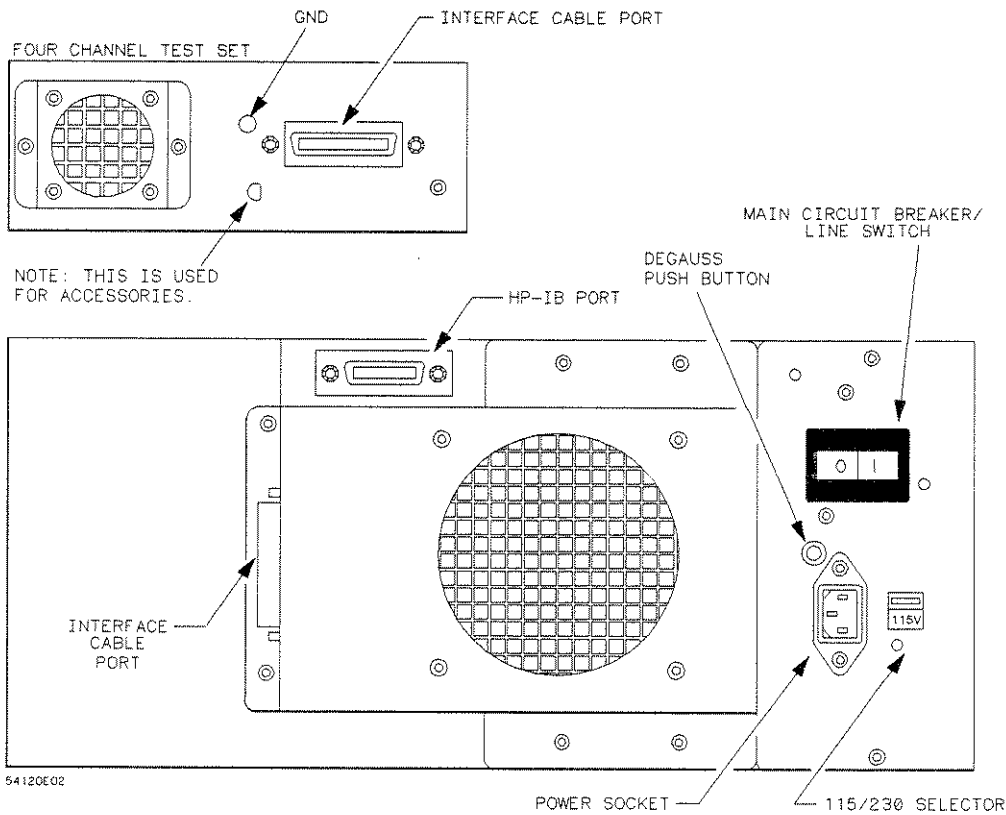

Figure 2-1. Power Module on Rear Panel

You can turn on the HP 54121T after you have selected the correct setting on the line select switch, installed the appropriate power cord, (refer to figure 2-3) and connected it to the power outlet. The trip current of the circuit breaker is 7.5 amps.

The HP 54121T has two switches that can interrupt the power to the instrument. The first is the line switch and the second is the (main) power breaker.

- the line switch is in the lower left hand corner of the front panel
- the mains breaker is in the upper right hand corner of the rear panel.

If the front panel power switch is in the **STBY** position or if the main breaker is in the **OFF** or **0** position, the HP 54121T will not function.

WARNING

If the main breaker is in the ON or 1 position, electrical current is present inside the HP 54121T. This current could cause electric shock and personal injury.

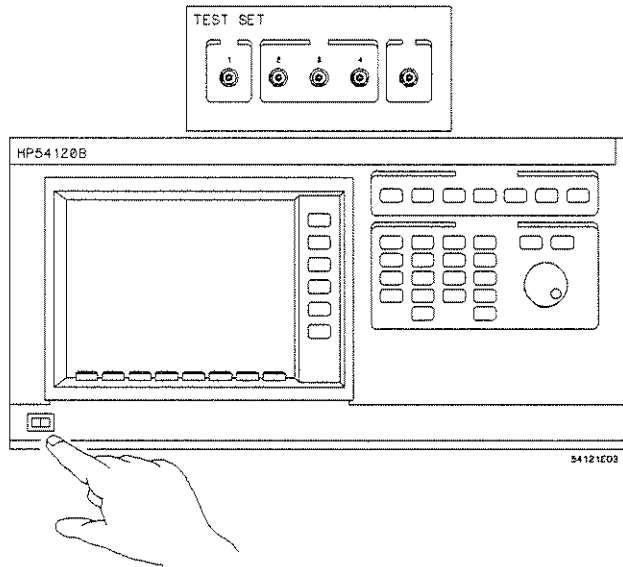

Figure 2-2. HP 54121T Front Panels

Initial Color Display Setup

The HP 54121T's electromagnetic color display may require degaussing (demagnetizing) at installation, or later if necessary. To facilitate degaussing, the display section contains a degaussing coil whose switch is on the rear panel. To degauss the CRT, press this switch several times.

If, in certain severe situations, internal degaussing does not correct a distorted display, you may have to use an external television-type degaussing coil.

Two screwdriver adjustments for brightness and background are on the front panel, to the left of the CRT. The background control sets the luminosity of the background of the CRT. The brightness control sets the gain of the video amplifier. It controls the intensity of the information displayed on the CRT.

List of Accessories

In addition to the optional accessories you may have ordered, the HP 54121T is shipped with the following:

- one power cable (refer to figure 2-3)
- five adapters, APC-3.5 mm (f-f) (HP P/N 5061-5311)
- five coaxial shorts, SMA (m) (HP P/N 0960-0055)
- one antistatic mat with wrist strap and user instructions (HP P/N 9300-1346)
- 54121-68701, RF accessory kit, which includes
 - five 20 dB attenuators, APC-3.5 mm (f-m) (HP P/N 33340C/20)
 - three 50 Ω cables, SMA (m-m) (HP P/N 8120-4948)
 - two SMA (m) to BNC (f) adapters (HP P/N 1250-1200)
 - one 50 Ω termination, SMA (m) (HP P/N 1250-2153)
 - one 50 Ω termination, SMA (f) (HP P/N 1250-2151)
 - one coaxial short, SMA (f) (HP P/N 1250-2152)
- one set of documentation, consisting of the following manuals:
 - *Getting Started Guide*
 - *Front-Panel Operation Reference*
 - *Programming Reference Manual*
 - *Service Manuals*







The following is a list of available accessories:

- HP 54006A 6 GHz Resistive Divider Probe Kit
- HP 54007A Accessory Kit
- HP 54008A 22 ns Delay Line
- HP 54118A 18 GHz Trigger

Refer to *HP 54121T Data Sheet* for other applicable accessories.

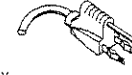
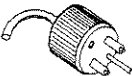
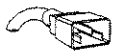
Note

Many parts from these kits are used in exercises in this manual.

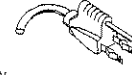
PLUG TYPE	CABLE PART NO.	PLUG DESCRIPTION	LENGTH IN/CM	COLOR	COUNTRY
DPT 900  250V	8120-1351 8120-1703	Straight *BS1363A 90°	90/228 90/228	Gray Mint Gray	United Kingdom, Cyprus, Nigeria, Zimbabwe, Singapore
DPT 901  250V	8120-1369 8120-0696	Straight *NZSS199/ASC 90°	79/200 87/221	Gray Mint Gray	Australia New Zealand
DPT 902  250V	8120-1689 8120-1692 8120-2857	Straight *CEE7-Y11 90° Straight (Shielded)	79/200 79/200 79/200	Mint Gray Mint Gray Coco Brown	East and West Europe, Saudi Arabia, So. Africa, India (Unpolarized in many nations)
DPT 903**  125V	8120-1378 8120-1521 8120-1992	Straight *NEMA5-15P 90° Straight (Medical) UL544	90/228 90/228 96/244	Jade Gray Jade Gray Black	United States, Canada, Mexico, Philippines, Taiwan
DPT 904**  250V	8120-0698	Straight *NEMA6-15P	90/228	Black	United States, Canada
DPT 905  250V	8120-1396 8120-1625	CEE22-V1 (System Cabinet Use) 250V	30/76 96/244	Jade Gray	For interconnecting system components and peripherals. United States and Canada only
DPT 906  250V	8120-2104 8120-2296	Straight *SEV1011 1959-24507 Type 12 90°	79/200 79/200	Mint Gray Mint Gray	Switzerland
DPT 912  220V	8120-2956 8120-2957	Straight *DHCK107 90°	79/200 79/200	Mint Gray Mint Gray	Denmark
DPT 917  250V	8120-4211 8120-4600	Straight SABS184 90°	79/200 79/200	Jade Gray	Republic of South Africa India
DPT 918  100V	8120-4753 8120-4754	Straight Miti 90°	90/230 90/230	Dark Gray	Japan

Rev. 1/90VBB

ART00016

*Part number shown for plug is industry identifier for plug only. Number shown for cable is HP part number for complete cable including plug.

**These cords are included in the CSA certification approval of the equipment.

E=Earth Ground
L=Line
N=Neutral

Figure 2-3. Available Power Cords

Making Measurements

3

Chapter Contents

This chapter contains information about how to acquire a waveform, how to make voltage and time measurements, and how to take advantage of some of the automatic features of the HP 54121T.

Overview

This chapter will help you become familiar with the steps for making some common measurements and using many of the built-in features of the HP 54121T.

The basic steps are listed in the left column, cautions and details about how to accomplish each step are in the right column.

If you need additional information about a step, check the index for the appropriate page and chapter.

Acquiring a Waveform

To acquire a waveform:

1. Insure the signal does not exceed ± 2 V max.

Voltages higher than ± 2 V max. can be destructive to the inputs of the HP 54121A.

You can use the fixed attenuators supplied with the HP 54121T to reduce the voltage at the channel inputs.

Remember that the maximum continuous power dissipation specification for these attenuators is 2 Watts – i.e., 10 volts rms or dc maximum.

To avoid electrostatic discharge (ESD), make sure you use the antistatic mat and wrist strap that are provided with the HP 54121T.

Not only do the antistatic mat and wrist strap protect the oscilloscope, but they also protect the device or system under test.

2. Connect the signal to the HP 54121A (channels 1 through 4).

Make sure you use the connector savers (F - F adapters) that were shipped with the unit from the factory. They will extend the life of the input connectors on the HP 54121A.

The input impedance of the HP 54121A is 50 Ω . In order to have the best signal fidelity, the source impedance should approximate 50 Ω .

If source loading is a concern, use the HP 54006A Resistive Divider Probe Kit. It provides either 500 Ω with 10:1 division ratio or 1 k Ω with 20:1 division ratio.

To correct for external signal attenuation, the ATTEN function of the Channels menu can be set to the appropriate value.

3. Connect the external trigger to the HP 54121A (TRIG input).

The HP 54121T does not have an internal trigger; therefore, you must provide an external trigger.

If you want to trigger on the same signal that is being used for a channel input use an HP 11667B power splitter that is provided in the HP 54007A Accessory Kit. Refer to figure 3-1. For demonstration purposes, a power splitter is not required if your pulse generator has a separate trigger output to connect to the HP 54121T's trigger input.

By using the HP 54008A Delay Line you can view the trigger event.

The input impedance of the trigger input is also 50Ω .

4. Press AUTOSCALE.

This automatically scales the vertical axis, sets the TIME/DIV to an appropriate value, turns on the correct channels, and sets the trigger level for the applied signals.

If AUTOSCALE fails to provide a displayed signal, one of two prompts will be displayed. "No Trigger Found" indicates that a trigger is not present and that an input signal to one of the channels may or may not be present. "No Signal Found" indicates that the oscilloscope could not find a signal at any of the channels inputs; however, a signal was found at the trigger input.

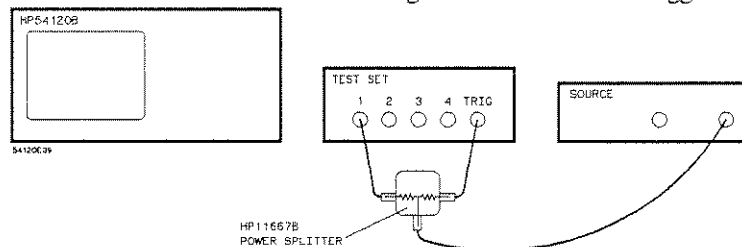

Figure 3 - 1. Acquiring a Waveform

Making a Voltage Measurement

To make a voltage measurement:

1. Acquire a waveform. Follow steps 1 - 4 in "Acquiring a Waveform."
2. Select the Measure menu. Automatic peak-to-peak and rms voltage measurements can be made by pressing the appropriate key on the Measure menu.
3. Select the Delta V menu. Provides access to the V markers.
4. Turn on the V Markers. If you want to measure discrete voltage levels on a waveform or to make differential voltage measurements, the V Markers can be adjusted to the desired levels and the results will be listed at the bottom of the display.

You can make source-to-source voltage measurements by assigning the V Markers to different channels and/or waveform memories.

Making a Time Measurement

To make a time measurement:

1. Acquire a signal. Follow steps 1-4 in "Acquiring a Waveform."
2. Select the Measure menu. Automatic time measurements (e.g., rise and fall times and width) can be made by pressing the appropriate key.
3. Select the Delta t menu. Provides access to the time markers.

4. Turn on the t Markers.

Time interval measurements can be made with the time markers.

Source-to-source time interval measurements can be made by displaying the appropriate sources and moving the time markers on the display.

For a more accurate time interval measurement, do a channel-to-channel skew cal. See Chapter 18 for more details on the skew cal.

Saving a Waveform

To save a waveform:

1. Acquire a waveform.

Follow steps 1-4 in "Acquiring a Waveform."

2. Select the Wfm Save menu.

You can store any of the waveform math functions or channels in waveform memories 1 through 4.

Automatic measurements may be used to characterize waveform memories.

An entire screen can be stored in pixel memories 5 or 6.

The automatic measurements from the Measure menu and the markers may be used with waveforms stored in waveform memories 1 through 4.

Automatic measurements may not be used with pixel memories 5 and 6, as these memories do not keep the time and voltage factors with the stored screen.

Printing or Plotting a Waveform

To print or plot a waveform:

1. Acquire a waveform.

Follow steps 1-4 in "Acquiring a Waveform."

2. Select the Utility menu.

This menu accesses the HP-IB menu. The printer or plotter must be connected directly to the HP 54121T via the HP-IB in order to make a hardcopy with the Print or Plot menu.

If you are using the oscilloscope to drive a printer or plotter directly you may not connect other HP-IB instruments.

3. Select the HP-IB menu.

This menu allows access to the keys controlling the HP-IB interface.

Note

The HP 54120B is shipped from the factory in the "Talk/Listen" mode.

4. Set the HP-IB function to "Talk Only."

This sets the oscilloscope so it outputs data over the HP-IB to a printer or plotter that has been set to the "Listen Always" mode. If the printer or plotter doesn't have a DIP switch on the rear panel labeled "Listen Always," set all the switches to "1." This will usually set the printer or plotter to the "Listen Always" mode.

5. Select the Print or Plot menu.

These menus allow you to define the options for the hardcopy output and to initiate the print or plot cycle.

Waveform displays with a large number of data points — i.e. persistence display mode — take an excessive amount of time to plot. For these cases we suggest you use a graphics printer.

Adding and Subtracting a Waveform

To add and subtract a waveform:

1. Acquire two waveforms.

Follow steps 1-4 in "Acquiring a Waveform." You may use channels or waveform memories 1-4 as sources for waveform math.

2. Select the Wfm Math menu.

The Wfm (waveform) Math menu allows you to add, subtract, and use other mathematical operators on channels or waveform memories (not pixel memories).

3. Select the math operator, (+ , - , etc.) and the sources (channels or waveform memories) that will be acted upon.

When the waveform math functions are displayed, they replace channels 1 and 2. This means that if you want to view the math functions and the channel sources at the same time you must use channels 3 and 4.

4. Turn function on.

Displays the function on.

Inverting a Waveform

To invert a waveform:

1. Acquire a waveform.
2. Select the Wfm Math menu.
3. Select the Invert operator.
4. Turn function display on.

Follow steps 1-4 in "Acquiring a Waveform." Waveform memories 1-4 may be used also.

The Waveform Math menu has math operators that help you evaluate waveforms. This menu also allows you to select the source(s) that are acted upon by the math operator.

The Invert operator automatically inverts the selected source.

Displays the function on.

Making a Pulse Measurement

To make a pulse measurement:

1. Acquire a pulse.

Follow steps 1-4 in "Acquiring a Waveform." Waveform memories 1-4 may be measured also. The source for the automatic pulse measurements must be displayed and must not be clipped.

2. Select the Measure menu.

The Measure menu has 11 automated measurements listed on three submenus. All of these measurements can be made by pressing the All key, or an individual measurement can be made by pressing the key for a specific measurement.

The Measure menu allows you to select either fine or coarse precision measurements. The coarse measurements use data that is currently on screen and require less time than precision measurements. Precision measurements rescale the timebase for optimum resolution and acquire new data.

All measurements on waveform memories are coarse measurements.

Making a TDR Measurement

To make a TDR measurement:

1. Select the Network menu. The Network menu gives you access to automatic network measurements like percent reflection (Rho) and impedance (Z).
2. Select the Cal submenu and press the Preset Reflect Channel key. This turns on the TDR pulse (ch1) and puts the oscilloscope in a known state.
3. Configure the channel 1 input to connect to the device under test. Use a high quality 50 Ω cable. For the Reflect cal to function properly, the end of the cable must be represented on the display.
4. Perform a Reflect Cal. Cal establishes a reference for all reflection measurements.
5. Connect the device under test to channel 1. Channel 1 provides a high quality pulse that can be used for time domain reflection and transmission measurements.
6. Select the Reflect submenu. The Reflect submenu provides access to the TDR functions.
7. Turn on the cursor. The cursor provides instantaneous values for the Delta t, distance, Rho, and impedance. The cursor can be assigned to either the live or normalized waveform.
8. Press Min & Max Reflect key. The Min & Max Reflect key causes markers to be placed at the min and max reflection levels. The results are also listed at the bottom of the display.

9. Evaluate the DUT with normalization.

Normalization allows you to evaluate the response of the DUT to a simulated perfect pulse with a defined risetime.

This allows you to simulate the response of the DUT to various rise-time edges.

Normalization must be performed with the oscilloscope at the same TIME/DIV, DELAY, and bandwidth settings that were used for reflect cal. If you change one of these parameters, and attempt a normalization, a prompt will list the required setup.

Measuring the Distribution of a Waveform

To measure the distribution of a waveform:

1. Acquire a waveform.

Follow steps 1-4 in "Acquiring a Waveform."

2. Select the Histogram menu.

The Histogram menu gives you control of data acquisition for the histogram and enables you to statistically evaluate this data.

The histogram function is an extension of the infinite persistence mode. When the Histogram menu is selected, the oscilloscope is automatically set to the infinite persistence display mode. If you leave the Histogram menu, the oscilloscope will return to its original display mode.

3. Select the Windows submenu.

The Windows submenu allows you to select the type of histogram and set the window markers.

4. Select the type of histogram to be generated.

The HP 54121T can generate either time or voltage histograms.

A jitter measurement would use a time histogram and a noise measurement would use a voltage histogram.

5. Set the WINDOW MARKERS to define the portion of the waveform that is used to generate the histogram.

When a time histogram is generated, a voltage window is used, and when a voltage histogram is generated, a time window is used.

6. Select the Acquire submenu and acquire the histogram data.

The number of samples selected influences the time required for completing the acquisition. Voltage histograms typically take less time to acquire than time histograms, especially if you are using a narrow window. For example, a typical voltage histogram with 10,000 samples will take less time to acquire than a time histogram with a narrow window using 300 samples.

7. Select the Results Submenu.

The Results submenu allows you to evaluate the histogram. Statistical data like mean, sigma (standard deviation), and accumulated percentage are available.

Front-Panel Overview

4

Chapter Contents

This chapter contains information on the 54120B system control, entry and selection keys along with color relations on the screen.

Front-Panel Organization

The HP 54120B has been designed to be very easy to use. To this end, its front panel is separated into three functional areas. These are:

- system control
- entry
- menu and function selection

You have complete local control of the instrument with these three areas.

System Control Keys

The SYSTEM CONTROL keys are along the top right half of the front panel. These keys control acquisition, active display, SAVE and RECALL registers, and automatic display scaling.

Throughout this chapter references are made to several of the HP 54121T's 14 menus. Each menu has its own section, which discusses the menu in detail.

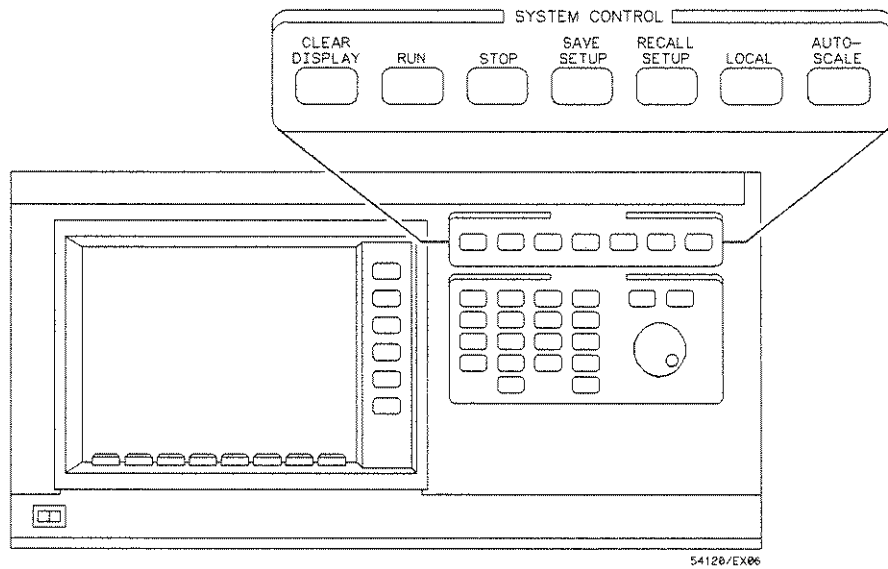

Figure 4-1. System Control Keys

**Clear Display
Key**

Pressing the CLEAR DISPLAY key:

- causes the HP 54121T to momentarily stop acquiring data erase the screen, and then resume acquiring data
- erases the dynamic (active) display
- but does not erase a stored waveform that is being displayed

If the CLEAR DISPLAY key is pressed after the STOP key is pressed:

- the screen remains clear and waveform acquisition does not resume until the RUN key is pressed

If you have selected a high number of averages (averaged display mode) and you change the input signal:

- you can quickly reset the average registers to the new signal levels by pressing the CLEAR DISPLAY key

This saves the time normally required by the display to settle to the new signal levels. For details about the averaged and persistence display modes see "Display Menu," chapter.

Run Key Pressing the RUN key:

- causes the HP 54120B to resume acquiring data after acquisition has been stopped by the STOP key

Stop Key If the STOP key is pressed:

- the instrument stops acquiring data and displays the last acquired data
 - to return to the previous operating mode, press the RUN key
- the instrument erases the active display if you change TIME/DIV, VOLTS/DIV, or press any other front-panel control that would normally cause the displayed waveform to change
 - this key works as if the CLEAR DISPLAY key had been pressed
- the status label in the upper-left corner of the display changes to "Stopped"

Save Setup and Recall Setup Keys

The HP 54120B allows you to SAVE and RECALL up to ten different front-panel setups in non-volatile memory.

To SAVE the current front-panel setup in one of the SAVE/RECALL registers:

- press SAVE SETUP, then press the number (0-9) of the register desired
 - a prompt tells you that the setup has been saved

This saves all front-panel functions, modes, and cal factors. This does not save menu selection and entry device assignments.

Note

The display does not change when you press SAVE.

Pressing SAVE SETUP/RECALL SETUP does not cause execution of measurements, preset levels, start print, or other action keys.

To RECALL a previously saved front-panel setup:

- press RECALL SETUP, then press the number (0-9) of the desired register
 - a prompt tells you that the setup has been recalled

Tip

To return to the condition that existed before the last AUTOSCALE, press RECALL SETUP, then press AUTOSCALE. This returns you to the previous front-panel setup if you need to recover from an accidental pressing of the AUTOSCALE key.

Local Key

When the LOCAL key is pressed:

- a rtl (return-to-local) message is sent to the HP-IB interface and the instrument returns to local (front-panel) control if the HP-IB controller has not invoked a local lockout

The LOCAL key is the only front-panel key that is active when the HP 54120B is in the remote mode.

Autoscale Key

When the AUTOSCALE key is pressed:

- the HP 54120B selects the vertical sensitivity, vertical offset, trigger level, and sweep speed for displaying the input signal

If only one of the vertical inputs has a signal present:

- the display is in the single-screen mode

If input signals are present on more than one input:

- the sweep speed is determined by the lowest numbered input with a signal present
- the display is in the split-screen mode when two signals are present, unless the two channels are 1 and 3 or 2 and 4, in which case quad screen is selected
 - AUTOSCALE will not overlay waveforms
- the display is in the quad mode when three or four signals are present
- the vertical sensitivity for each input is scaled appropriately

When the AUTOSCALE cycle is complete:

- the Timebase menu and TIME/DIV function are selected

If AUTOSCALE is pressed accidentally, you can return the oscilloscope to its previous condition by pressing RECALL and AUTOSCALE sequentially.

Entry Devices

Under the SYSTEM CONTROL keys is an area labeled ENTRY. In this portion of the front panel are the entry devices, which include:

- a number pad with a vertical column of five ENTER keys
 - after you enter a number, you must press one of the ENTER keys
- a knob
- two increment/decrement keys (step keys)

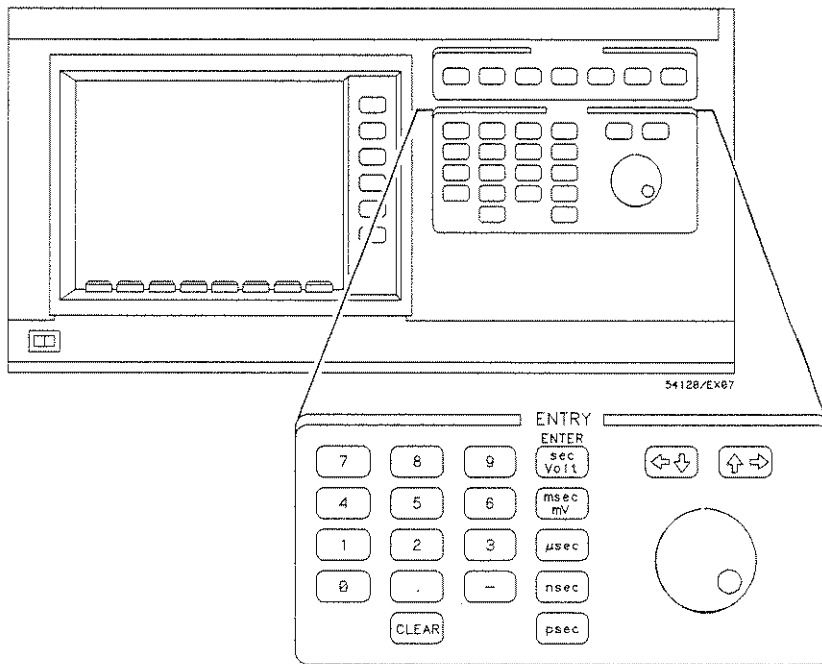

Figure 4-2. Entry Devices

The entry devices are used to change the value of any items displayed in capital letters (VOLTS/DIV and TIME/DIV) in the function menus.

Menu and Function Selection Softkeys

The HP 54120B provides two sets of softkeys that enable you to control the instrument's front panel.

The first set (menu selection) is across the bottom of the CRT.

- Menu selection keys are used to choose a desired function menu.
- Pressing a menu selection key changes the second set of softkeys.

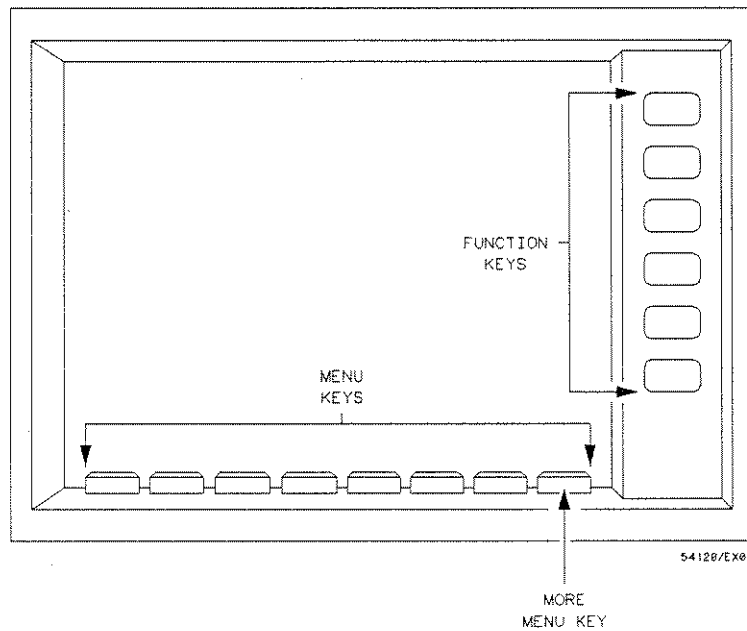

Figure 4-3. Menu Selection Keys

- Pressing the more key (the key furthest to the right) lists an additional set of menu selections.
- Pressing the more key a second time returns you to the original menu.

The second set (function selection) is along the right side of the CRT.

Some function keys are displayed in inverse video.

- When these keys are pressed, the text in inverse video changes.
 - Example: pressing the top key when you are in the Channels menu allows you to choose one of the four inputs.

Some function keys are displayed in all capital letters.

- When these keys are pressed, their value can be changed with any entry device, and the value is displayed in the top center of the CRT.
 - Example: pressing the TIME/DIV key when you are in the Timebase menu allows you to enter the sweep speed for the input signal you want to display.

Some function keys are displayed with the first letter of each word capitalized and all other letters lowercase.

- When these keys are pressed, the function executes immediately.
 - Example: pressing the All key in the Measure menu causes the oscilloscope to perform 11 parametric measurements on the designated waveform.

Color

Function key labels and waveform factors associated with a specific channel, function, memory, or marker are highlighted in the same color. For example, the channel 1 trace and the associated key labels and waveform factors are displayed in yellow.

Note

Whenever you use a function key to select a waveform source, the text of the selected source is the same color as the source's waveform. For example, if the default colors are used, all text relating to channel 1 or function 1 is yellow and all text relating to channel 2 or function 2 is green.

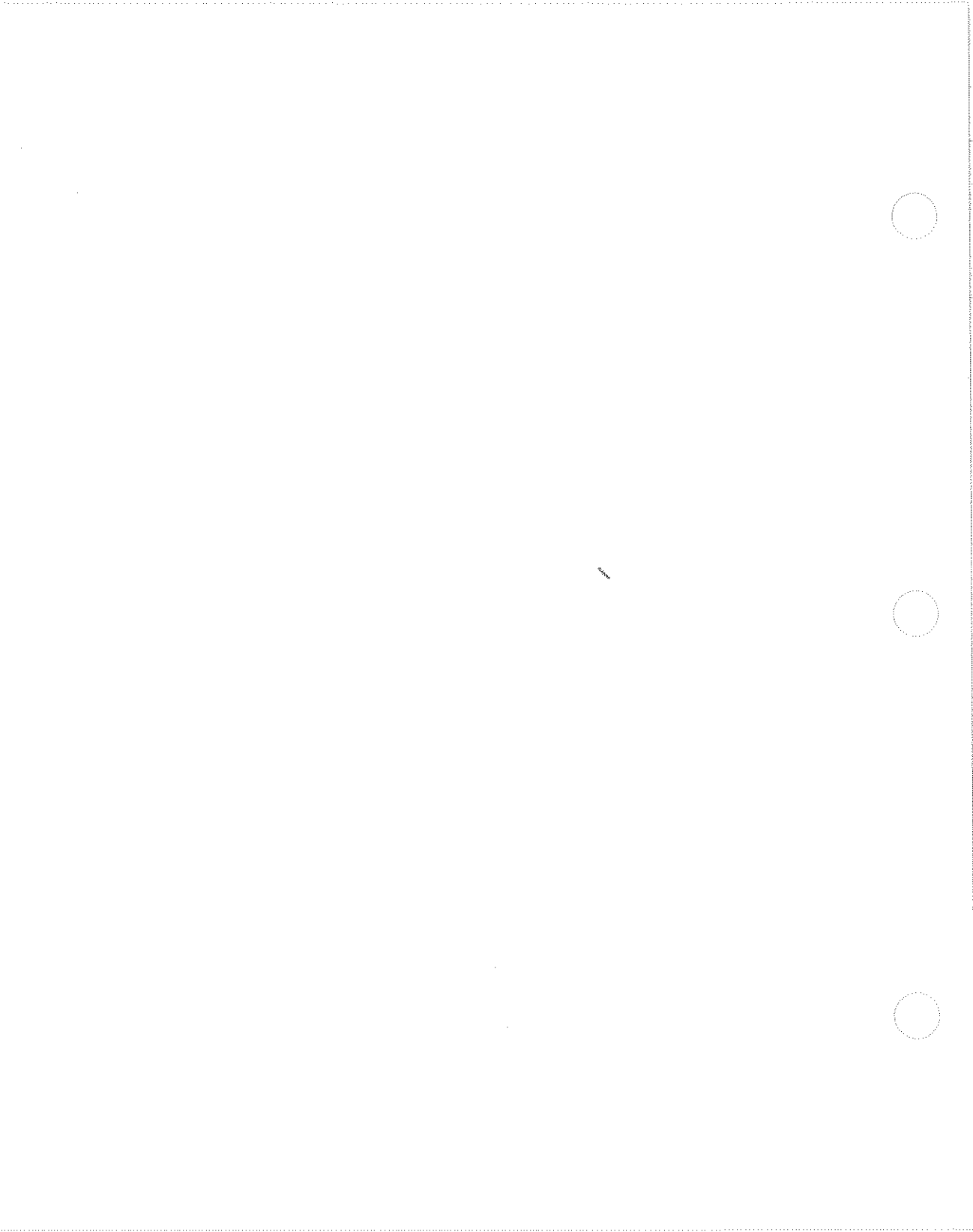

Channels Menu

Chapter Contents

This chapter contains information on how this menu is used to control the vertical display, including vertical scaling, offset, and attenuation factors.

Overview

The Channels menu allows you to control the vertical operation of the display as well as some easy-to-use features of the HP 54120B. For example, you can set the attenuation factors independently for the four vertical inputs.

When you select the Channels menu, either OFFSET, VOLTS/DIV, or ATTEN is highlighted in the same color as the selected channel indicating that function is active.

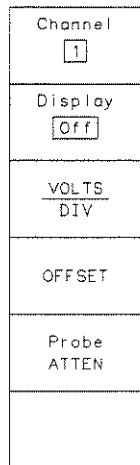

54120B15

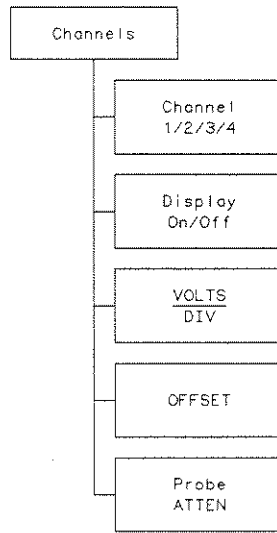

54120B93

Figure 5-1. Channels Menu

Channel Select Key

Pressing the Channel key toggles it through channels 1 - 4 sequentially and assigns the function keys to the selected channel.

Display On/Off Key

Pressing the Display On/Off key:

- turns the display for the selection on or off
- changes the label from on to off or vice versa

Volts/Div Key

The VOLTS/DIV key allows you to set the vertical sensitivity of the selected channel with one of the three entry devices.

- With the number pad and appropriate units key under ENTER you can set sensitivity to three-digit resolution. The oscilloscope will round the input to the nearest mV.
- By turning the knob clockwise, you can increase sensitivity in a 1-2-5 sequence, and by turning the knob counterclockwise you can decrease sensitivity in a 5-2-1 sequence.
- With the increment/decrement (step) keys you can change sensitivity in a 1-2-5 and 5-2-1 sequence.

The range of VOLTS/DIV is from 1 mV to 80 mV with a resolution of 1 mV. VOLTS/DIV changes automatically if the display screen mode (single, dual, or quad) or the attenuation factor is changed.

Offset Key

OFFSET allows you to move the trace of the selected channel up or down with the number pad, knob, or the step keys.

This function works much the same way as a vertical position control on a conventional oscilloscope. The OFFSET voltage, equal to the voltage at center screen, is shown at the top of the display.

The range of OFFSET is from -500 mV to $+500$ mV with 0.125 mV resolution.

Probe Atten Key

The attenuation function is provided so you can make measurements with attenuator probes and have the measurement results reflect the actual voltage levels at the probe tip(s).

Pressing the ATTEN key allows you to set the channel attenuation factor for the selected channel from $1/1,000,000$ to 1000 . Fractional values are entered in decimal format. For example:

$1/1,000,000$ is entered as 1μ and

$1/1,000$ is entered as 1 mili

The channel attenuation factor is used to establish a data base for:

- generating the VOLTS/DIV and OFFSET prompts on the display
- calculating the automated waveform measurements
- V marker levels
- calculating functions

Note

Changing the channel attenuation factor DOES NOT attenuate the input signal, it only changes the data base for generating prompts on the display and calculating the results of the automated waveform measurements. If the input signal must be attenuated, use EXTERNAL ATTENUATORS.

Table 4-1. *dV Versus Voltage Ratio*

dB	Voltage Ratio	Gain Value
3 dB	1.41	0.7072
6 dB	2.00	0.5000
10 dB	3.16	0.3165
20 dB	10	0.1000
40 dB	100	0.0100

Timebase Menu

6

Chapter Contents

- how the Timebase menu is used to control the horizontal display

Overview

The Timebase menu:

- is the menu selected after an AUTOSCALE is performed
- allows you to control the horizontal display through the TIME/DIV, DELAY, and Delay Reference functions.

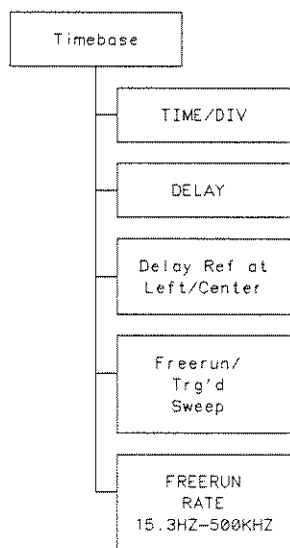

54120/BL07

Figure 6-1. Timebase Menu

Time/Div Key

The HP 54121T's TIME/DIV function is very similar to the time/division knob on an analog oscilloscope. (Division in this instance equals 1/10 of the horizontal axis.)

The TIME/DIV function allows you to vary the time scale on the X-axis from 1 s/div to 10 ps/div with one of the three entry devices.

- The number pad and the appropriate units key allow three digits of resolution. The oscilloscope rounds the input to the nearest ps/div.
- The knob or the step keys changes the TIME/DIV in a 1-2-5 and a 5-2-1 sequence.

Delay Key

The HP 54121T's DELAY function is similar to the horizontal position control on an analog oscilloscope and defines the time offset relative to the trigger.

The DELAY function controls the delay from trigger and can be changed with the entry devices. The maximum post-trigger delay varies with the sweep speed, and the minimum delay is limited by the propagation delay of the trigger path.

If the DELAY function is selected:

- delay time is displayed at the top of the waveform display area
- maximum delay time = 1000 screen diameters or 10 seconds whichever is smaller
- minimum delay time = 16 ns

Hint

Minimum delay can be quickly selected by entering 0 sec with the numeric keypad.

Delay Reference Key

Triggered
Sweep
Menu

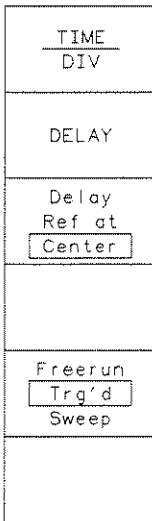

54120B16

The Delay Reference key allows you to select either the center or left of the display as the reference for the delay time. The selected delay is referenced to the sweep trigger.

If the TIME/DIV is changed, the signal will expand or contract about the delay reference point.

Pressing the Delay Ref at Left/Center key:

- toggles the delay reference between center and left of the display
- causes an arrow at the bottom of the display area to point to the delay reference
- provides a prompt at the bottom of the waveform display showing the amount of delay

If Delay Ref is set to Center:

- the delay will be referenced to the horizontal center of the display
- minimum delay is 16.05 ns and varies with TIME/DIV setting

If Delay Ref is set to Left:

- the delay will be referenced to the left of the display
- minimum delay is 16 ns

The Delay Ref at Left/Center key allows you to choose the left or center of the display as the reference when the TIME/DIV setting is adjusted. If you increase this setting, the waveform will expand about the reference point.

Freerun Trg'd Sweep Key

Freerun
Sweep
Menu

TIME DIV
DELAY
Delay Ref at Center
Freerun Trg'd Sweep
FREERUN RATE 500 KHz

54120B64

The Freerun Trg'd Sweep key allows you to use the external trigger input or the internal generator to trigger the sweep. The freerun sweep function synchronizes the sweep with the internal generator that also generates the TDR pulse for the Network menu. The triggered (trg'd) sweep function synchronizes the sweep with the external trigger input.

If you choose Triggered Sweep and no trigger is present:

- the HP 54121T does not sweep
- the data acquired on the previous trigger remains on screen

If you choose Triggered Sweep, no trigger is present and no previous data is available the screen will remain blank.

If you choose Triggered Sweep and a trigger is present a synchronous sweep is provided.

If you choose Freerun Sweep:

- the FREERUN RATE key is turned on
- a freerun rate generator is used to create a sweep
- the HP 54120B displays a baseline when no signal or trigger signal is present
- the display is unsynchronized when a signal is present but not triggered
- you can vary the freerun rate with the entry devices

The freerun trigger allows you to determine if signals are present while you're rapidly probing from point-to-point as would be the case if you were troubleshooting a circuit.

If you use the freerun trigger as a troubleshooting tool, use the persistence display mode (300 ms persistence time works well for this application). If the averaged display mode is used in this application, the oscilloscope averages the asynchronous acquired samples to a base line.

Note

For the most accurate measurement when you are using the freerun mode, make sure the external trigger is disconnected.

Freerun Rate Key

Pressing the FREERUN RATE key:

- allows you to vary the rate of the freerun rate generator from 15.3 Hz to 500 kHz
- varying the freerun rate controls the repetition rate of the TDR pulse when you are in the Network menu

Note

Reducing the frequency of the freerun rate generator allows you to make TDR and transmission measurements with longer transmission lines and devices with a longer settling time.

Hint

Selecting freerun will cause the input signal to be digitized even if a trigger signal is missing. Accurate amplitude measurements can be made in this way.

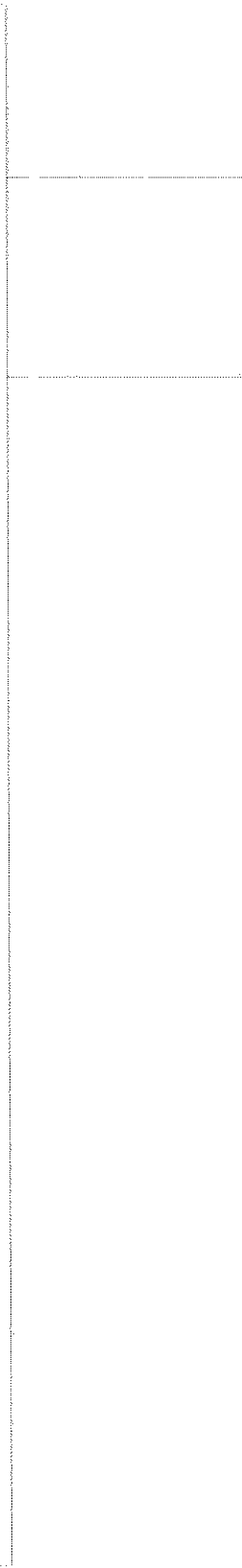
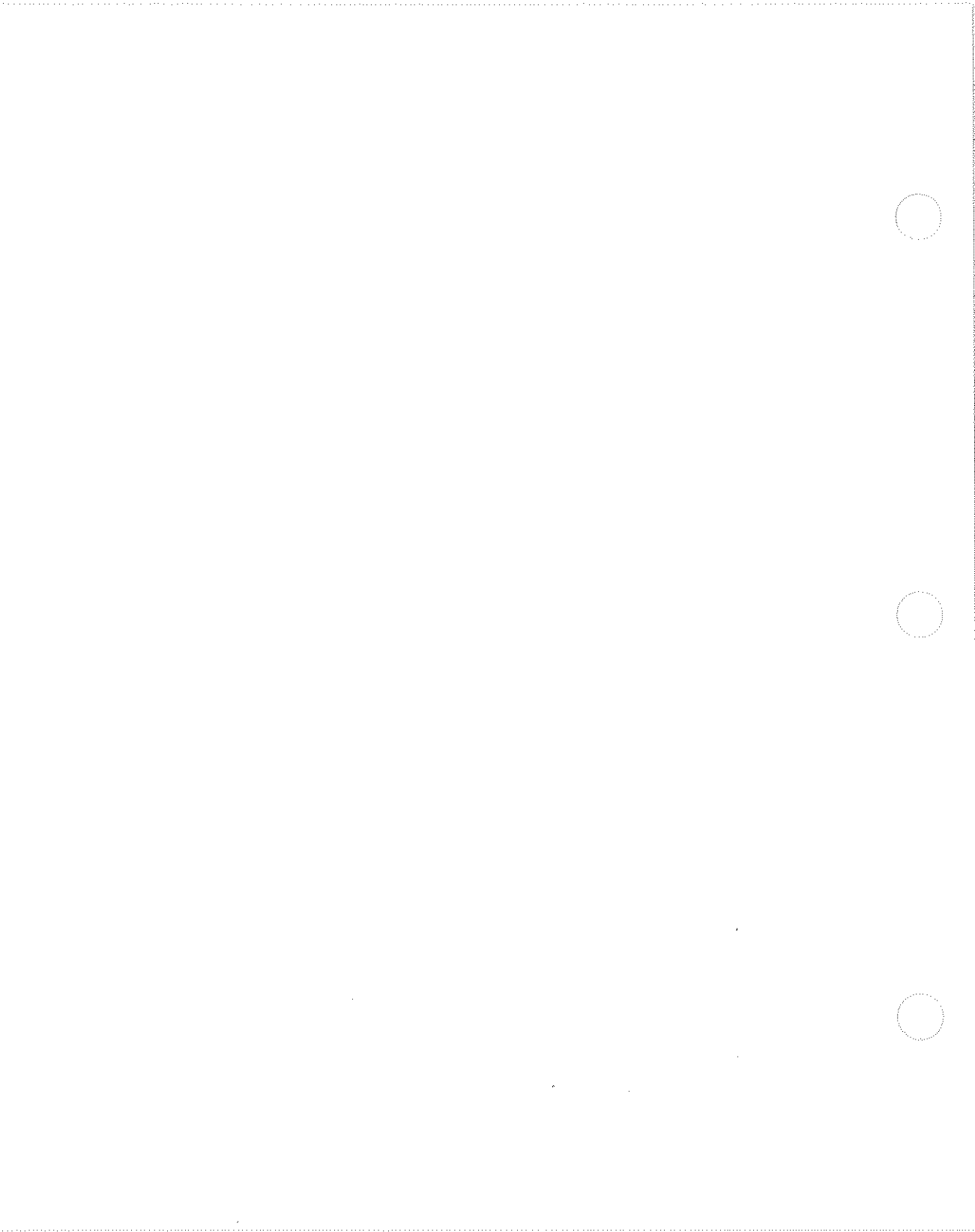

Trigger Menu

7

Chapter Contents

This chapter contains information about:

- the triggering capabilities of the HP 54121T
- the function keys of the Trigger menu

Overview

The Trigger menu allows you to synchronize the input signal(s) with the signal that is applied to the TRIG input of the HP 54121A Test Set.

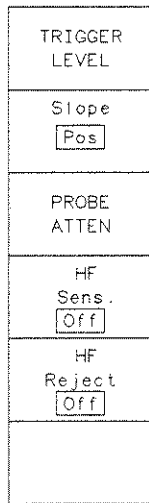

54120817

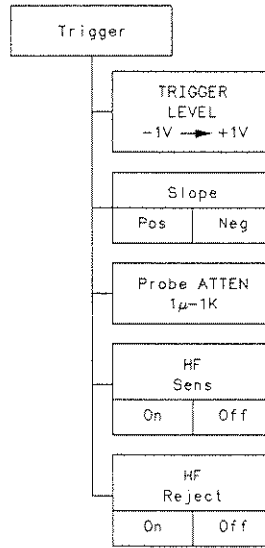

54120895

Figure 7-1. Trigger Menu

The Trigger menu allows you to:

- set the trigger level
- select the positive or negative slope of the trigger signal as the trigger event
- set the external attenuation factor for the trigger input

Trigger Level Key

Pressing the TRIGGER LEVEL key allows you to:

- set trigger level from +1 V to -1 V with attenuation factor = 1
- set the trigger level with any entry device
- displays the trigger level at the top of the display area

Slope Key

Pressing the Slope key allows you to select either the positive or negative edge of the trigger signal as the trigger event

Probe Atten Key

Pressing the PROBE ATTEN key allows you to:

- set the trigger attenuation factor for defining the trigger level prompt on the display
- the trigger attenuation factor can be set from 1 μ to 1000 with any entry device

Note

Changing the trigger attenuation factor does not attenuate the trigger signal, it only changes the scaling factor for generating the trigger level prompt on the display. If you have to attenuate the trigger signal, use an external attenuator.

HF Sensitivity Key

When this function is On, trigger hysteresis is turned off to lower the voltage required to trigger the instrument. Refer to figure 7-1.

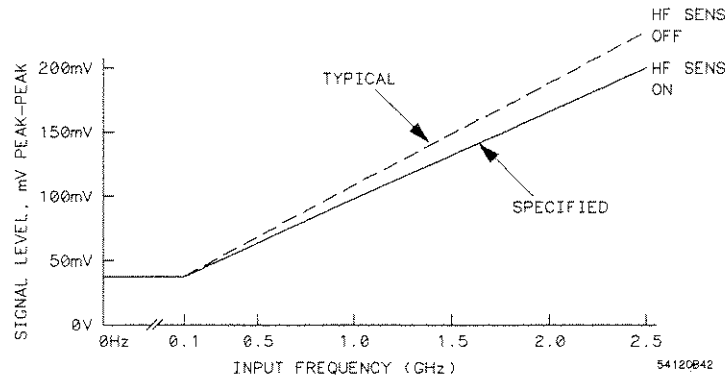
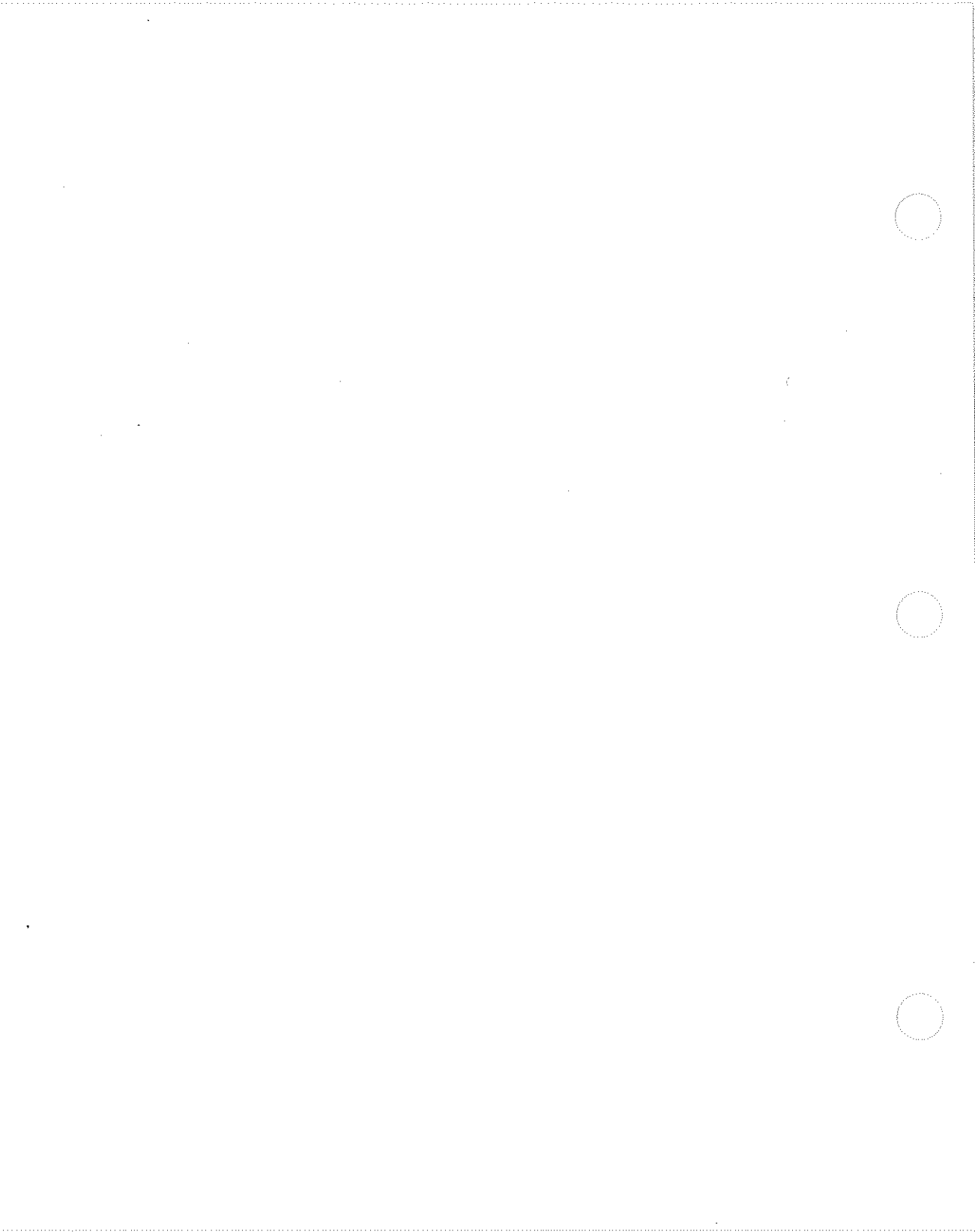

Figure 7-1. Trigger Sensitivity

If the trigger sensitivity is on, a double trigger will most likely occur at the low frequencies due to noise. To eliminate this effect, use this function only at higher frequencies.

HF Reject Key

When this function is turned On, the trigger bandwidth is reduced to less than 100 MHz. When this function is Off, the full trigger bandwidth of 2.5 GHz is used.



Display Menu

8

Chapter Contents

- the persistence and averaged display modes
 - the advantages of using either the persistence or averaged display modes
 - the tradeoff between throughput and accuracy
 - how to use display persistence as a measurement aid
 - tips about which display mode to use for different types of measurements
 - an exercise using infinite persistence to evaluate signal jitter
 - an exercise demonstrating the effect of the averaged display mode on a signal with time jitter
-

Overview

The Display menu allows you to:

- configure the HP 54120B for either persistence or averaged display mode
- vary the display time from 300 ms to infinite (persistence mode)
- vary the number of averages from 1 to 2048 in powers of 2 (averaged mode)
- define the waveform display area for single or multiple waveform displays
- define the type of graticule that is used
- extend bandwidth

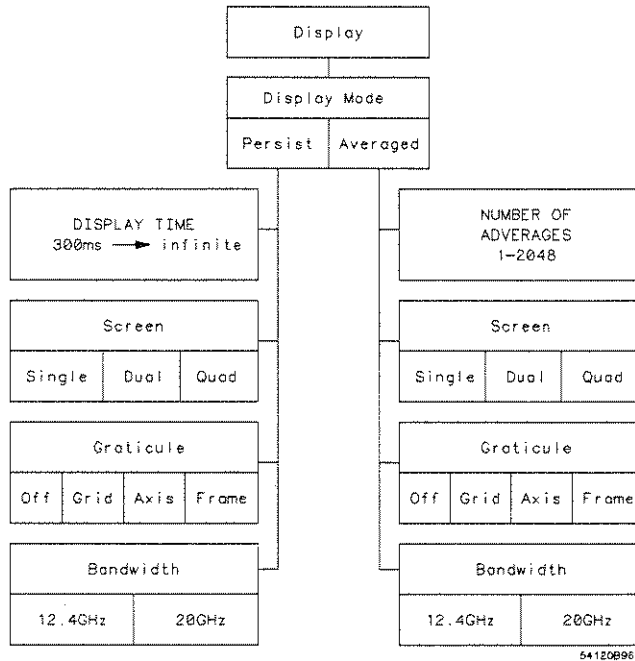

Figure 8-1. Display Menu

Display Mode Key

Pressing the Display Mode key allows you to select:

- persistence display mode
- averaged display mode

In the persistence display mode each data point is displayed as it is acquired and is kept on the display for a definable period of time.

If the persistence display mode is selected:

Display Mode Persist
DISPLAY TIME
Screen Single
Graticule Off
Bandwidth 20.0 GHz

- DISPLAY TIME key is activated and coupled to the entry devices
- data is maintained on the display with the entry devices for a defined period of time or indefinitely
 - minimum display time (persistence) is 300 ms
 - any display time equal to or greater than 11 s defaults to "Infinite"
- persistence time is listed at the top of display
- The oscilloscope's bandwidth is selectable by the bandwidth key

In the infinite persistence mode:

- data points remain on the display until
 - CLEAR DISPLAY key is pressed or
 - an instrument control that would normally change the display is used

If variable persistence (persistence less than 11 seconds) is selected:

Display Mode Averaged
NUMBER OF AVERAGES
Screen Single
Graticule Off
Bandwidth 20.0 GHz

- a flexible display changes with variations in the input signal
- the instrument stores the signal indefinitely on the display if the trigger is lost and the unit is in Trg'd Sweep

A minimum persistence setting is useful when the input signal is changing and you need immediate feedback, such as for rapidly probing from point to point and setting the amplitude or frequency of a signal source. More persistence is useful when you are observing long-term changes in the signal or low-signal repetition rates. Infinite persistence is useful for worst-case characterizations of signal noise, jitter, drift, timing, etc.

54120B18

Selecting the averaged display mode:

- activates and couples the NUMBER OF AVERAGES key to the entry devices
- specifies the number of averages from 1 to 2048 in powers of 2
- averages data from multiple acquisitions to create the displayed waveform(s)
- Bandwidth key toggles between 12.4 GHz and 20 GHz

In the averaging mode, the last acquired data points are averaged with previously acquired data before they are displayed.

Displayed noise can be significantly reduced with the averaged mode. As the number of averages is increased, the display becomes less responsive to changes in the input signal(s); however, more averages reduces noise, improves resolution, and increases repeatability.

Bandwidth Key

Pressing the Bandwidth key allows you to select:

- 20 GHz bandwidth mode
 - maximum bandwidth for channel 1 is 18 GHz
- 12.4 GHz bandwidth mode

If you do not need 20 GHz bandwidth (18 GHz on channel 1), use the 12.4 GHz bandwidth to keep the signal-to-noise ratio at the best possible level.

Screen Key

The Screen key allows you to define the waveform display area as:

- Single (one area)
 - all input signals, displayed memories, and displayed functions** are superimposed in the waveform display area
- Dual (two separate areas)
 - channels 1 and 3 and function 1 are displayed in the top half of the display
 - channels 2 and 4 and function 2 are displayed in the bottom half
 - any waveform memories may be independently displayed in either half of the display
- Quad (four separate areas)
 - channel 1 or function 1 is displayed in the top area
 - channel 2 or function 2 is displayed in the second area
 - channel 3 and 4 are displayed in the third and fourth areas respectively
 - any waveform memories may be independently displayed in any of the four display areas
- vertical scaling is changed automatically to provide an appropriate display as the screen function is changed

** "Functions" refers to the functions you can set up in the *Wfm Math (Waveform Math)* menu. See Chapter 12.

Graticule Key

Pressing the Graticule key allows you to:

- change or remove the display graticule

The graticule selections are:

- Grid
- Axes
- Frame
- Off

Tip

You'll find that the frame graticule makes it easier to see the Delta t and Delta V markers.

Infinite Persistence Exercise

The objective of this exercise is to evaluate time jitter on a signal with the infinite persistence display mode.

Equipment required:

- HP 8116A function generator (or equivalent)
- HP 54121T oscilloscope
- miscellaneous coax cables, SMA and 3.5 mm precision connectors and adapters
- HP 11667B power splitter

Tip

Infinite persistence can be quickly selected by entering 11 sec with the numeric keypad.

WARNING

Before connecting the HP 54121A test set to a signal source, ensure that the source does not exceed $\pm 2 V$. If the input signal exceeds these limits, **PERMANENT DAMAGE** to the instrument will result.

Equipment configuration:

- Connect the output of the function generator to the channel 1 and trigger inputs of the HP 54121A test set with the power splitter. See figure 8-2. For demonstration purposes, a power splitter is not required if your pulse generator has a separate trigger output to connect to the HP 54121T's trigger input.

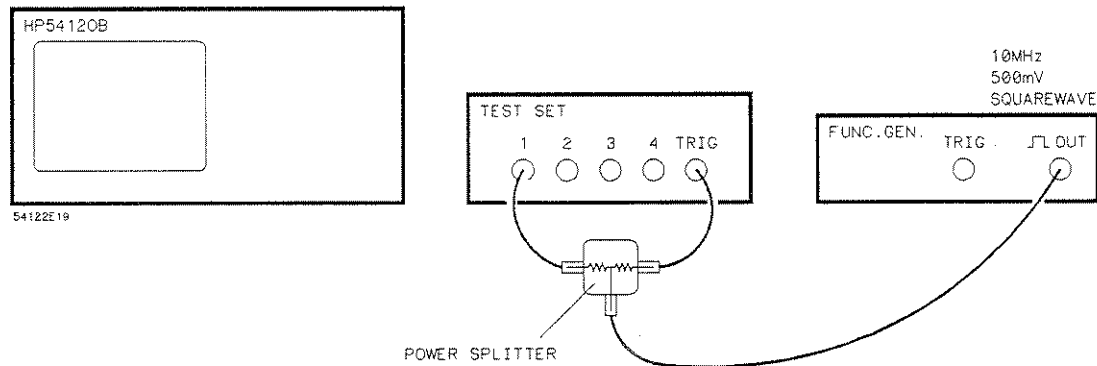

Figure 8-2. Equipment Configuration.

Initial Instrument Setup

- HP 8116A function generator
 - set for 500 mV p-p, 10 MHz square wave
- HP 54121T
 - press **AUTOSCALE**
 - set **TIME/DIV** = 20 ns/div
 - set **DELAY** to 200 μ s
 - select the Display menu and set **Display Mode** to **Persist**
 - set **Persistence** to infinite with the entry devices

Note that after several acquisitions, the leading and trailing edges of the square wave are undefined. See figure 8-3. This is caused by the phase noise on the input signal. Unless a signal source is extremely stable, jitter of this magnitude is common when long delays are used.

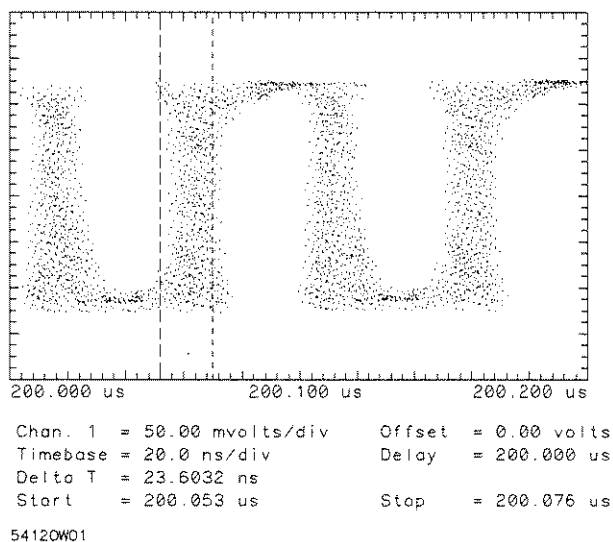

Figure 8-3. Jitter in Persistence Mode

The function generator used in this exercise demonstrated approximately 23 ns time jitter with 200 μ s delay.

Tip

Use the Delta t markers to measure horizontal (time) jitter.

Averaged Display Mode Exercise

The objective of this exercise is to demonstrate an error source that exists when the averaged display mode is used with a signal that has jitter.

Equipment required:

- HP 8116A function generator (or equivalent)
- HP 54121T oscilloscope
- miscellaneous coax cables, SMA and 3.5 mm precision connectors and adapters
- HP 11667B power splitter

WARNING

Before connecting the HP 54121A test set to a signal source, ensure that the source does not exceed ± 2 V. If the input signal exceeds these limits, PERMANENT DAMAGE to the instrument will result.

Equipment configuration:

- Connect the output of the function generator to the channel 1 and trigger inputs of the HP 54121A test set with the power splitter. (See figure 8-2.)

Initial Instrument Setup

HP 8116A function generator:

- set for 500 mV p-p, 10 MHz square wave

HP 54121T:

- press **AUTOSCALE**
- set **TIME/DIV** = 20 ns/div
- set **DELAY** to 200 μ s
- select the Display menu and set Display Mode to Averaged
- set **NUMBER OF AVERAGES** = 64

Note that after several acquisitions, the leading and lagging edges of the square wave are sloped. See figure 8-4. This is caused by averaging when jitter is present.

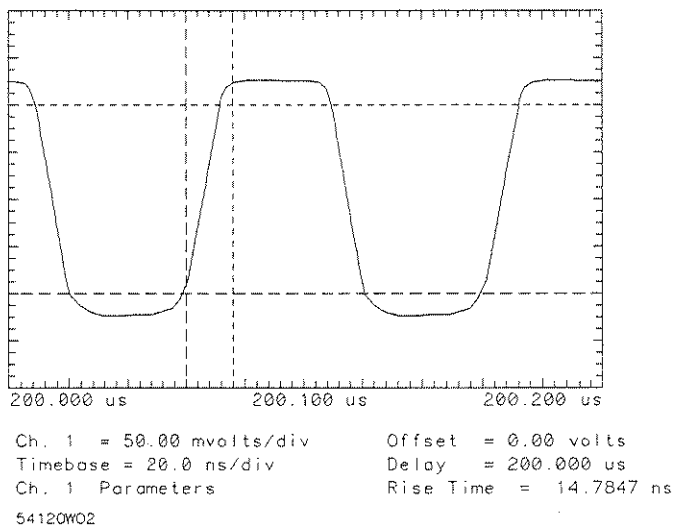

Figure 8-4. Risetime Measurement with Jitter (Averaged Mode)

To demonstrate the loss of accuracy, select the Measure menu and measure the rise time using 200 μ s DELAY.

- Note that the risetime is approximately 15 ns. Refer to figure 8-4.

To eliminate the induced jitter:

- Select the Timebase menu and set the DELAY to 16 ns.
- Select the Measure menu and repeat the rise-time measurement.
- Notice that the risetime on the same square wave without jitter is approximately 4.4 ns. See figure 8-5.

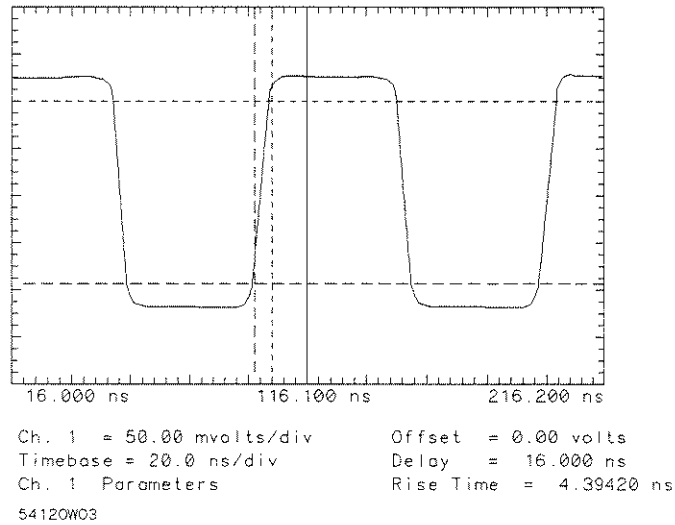

Figure 8-5. Risetime Measurement without Jitter (Averaged Mode)

Note

If you use the averaged display mode with jitter present, the oscilloscope may not faithfully reproduce the signal.

Figures 8-6 and 8-7 compare the results of the persistence and averaged display modes when time jitter is present.

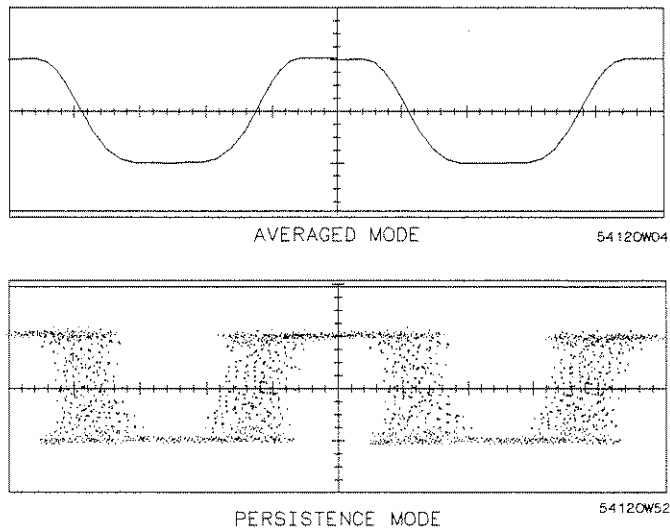

Figure 8-6. The Persistence and Averaged Display Modes with Time Jitter

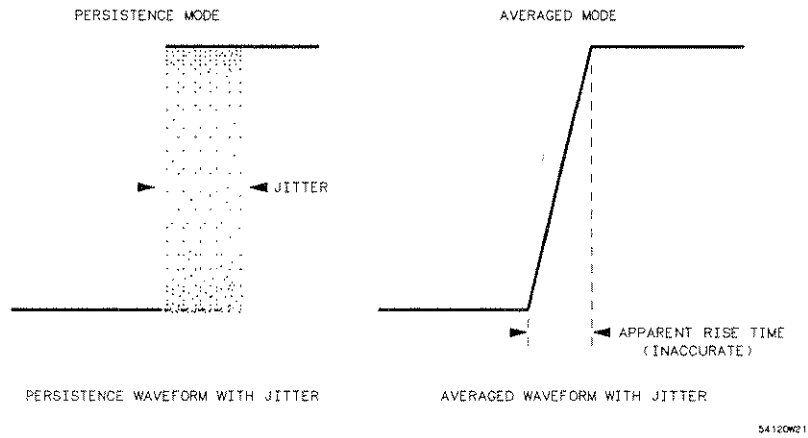

Figure 8-7. Time Jitter with Persistence display mode

Waveform Save Menu

9

Chapter Contents

This chapter tells you how to store and view waveforms in the waveform and pixel memories.

Overview

The Wfm Save menu allows you to:

- access the six memories available from the HP 54120B's front panel
 - four are waveform memories designated as waveform memories 1 through 4 (automatic measurements may be used on waveform memories 1-4)
 - two are pixel memories designated as pixel memories 5 and 6

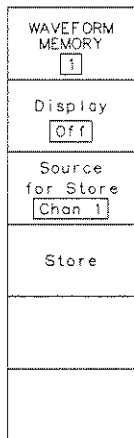

54120B19

Waveform memories (memories 1-4) are nonvolatile – the data in these waveform records is maintained when the instrument is turned off. Pixel memories 5 and 6, however, are volatile and the data in these memories is lost when the instrument is turned off.

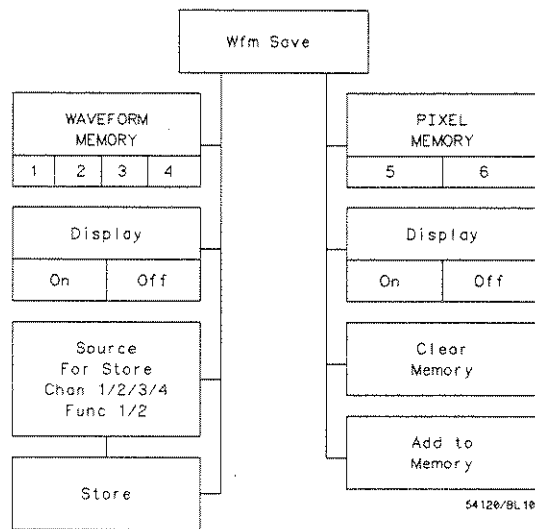

Figure 9-1. Waveform Menu

Memory Selection

After you have selected the Wfm (Waveform) Save menu, the WAVEFORM/PIXEL MEMORY key (the top function key) is highlighted, allowing you to choose one of the following selections with one of the entry devices:

- waveform memory 1 through 4
- pixel memory 5 or 6

Pixel Memories

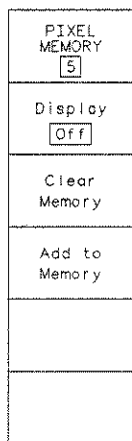

94120B20

Pixel memories are primarily for comparing multiple signal acquisitions and multi-valued waveforms.

Pixel memories 5 and 6 are:

- 256 x 501 bit memories
- constructed so that multi-valued waveforms can be stored in each

If more than one waveform is stored in a pixel memory, the waveforms are superimposed.

When you select pixel memories 5 and 6:

- the third key in the menu changes to the Clear Memory key allowing you to erase whatever is stored in the selected pixel memory
- the fourth key becomes the Add to Memory key. When pressed it stores all displayed channels and functions to the selected pixel memory, where they join whatever data is already stored there

Note

You cannot make measurements on waveforms stored in a pixel memory because waveform factors are not maintained.

Waveform Memories

When waveforms are stored to one of the four waveform memories the following waveform factors are stored as part of the record:

- VOLTS/DIV
- OFFSET
- TIME/DIV
- DELAY

This allows you to make measurements on these waveforms or to use them as operands for Wfm (Waveform) Math functions** (Function2 = Mem3 + Chan2) – e.g., functions can be scaled with VOLTS/DIV and OFFSET in the Waveform Math menu.

Note

Waveform memories can store only one waveform at a time. If you store a waveform to a memory that already contains a waveform record, the first record is written over and lost.

** "Functions" refers to the functions you can set up in the Wfm Math (Waveform Math) menu. See Chapter 12.

Display Key

The Display key allows you to:

- display or not display the waveform in the selected memory
- select in what portion of the screen the memory is to be displayed
 - valid only in the dual or quad screen mode. See Chapter 8 "Display Menu"

In the Single Screen mode the Display key turns the display of the selected memory on and off.

In the Dual Screen mode the screen is divided into two display areas, and the Display key allows you to select from the following options:

- off - blanks the memory display
- screen 1 - displays the selected memory at the top of the screen
- screen 2 - displays the selected memory at the bottom of the screen

In the Quad Screen mode the screen is divided into four display areas, and the Display key allows you to select from the following:

- off - blanks the display of the waveform stored in the selected memory
- screen 1 - displays the selected memory at the top of the display
- screen 2 - displays the selected memory in the second display area
- screen 3 - displays the selected memory in the third display area
- screen 4 - displays the selected memory in the fourth display area

Source for Store Key

The Source for Store key allows you to select the source to be stored in the specified WAVEFORM MEMORY.

For a source to be available as the Source for Store:

- the source must be turned on
- if more than one source is on, this key allows you to toggle through them

The available sources are:

- channels 1 through 4 available on the Channels menu
- functions 1 and 2 are:
 - available on the Wfm Math menu
 - mutually exclusive with channels 1 and 2

Store Key

Pressing the Store key stores the source in the selected waveform memory.

Note

If you store a waveform to a waveform memory with the oscilloscope in the persistence display mode, the last acquired data will be stored. If you use a long display persistence, the stored waveform may be different than the display.

If you store a waveform to a waveform memory with the oscilloscope in the averaged display mode, the waveform will be stored exactly as it is displayed.

Chapter Contents

- the voltage markers and automatic preset levels
- an exercise demonstrating the automatic preset voltage marker levels
- an exercise illustrating how to make a source-to-source voltage measurement

Overview

The Delta V menu allows you to control two calibrated horizontal markers for:

- making absolute voltage measurements
- reference markers when you are adjusting a signal to a given amplitude
- defining thresholds for time measurements

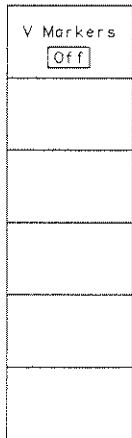

54120821

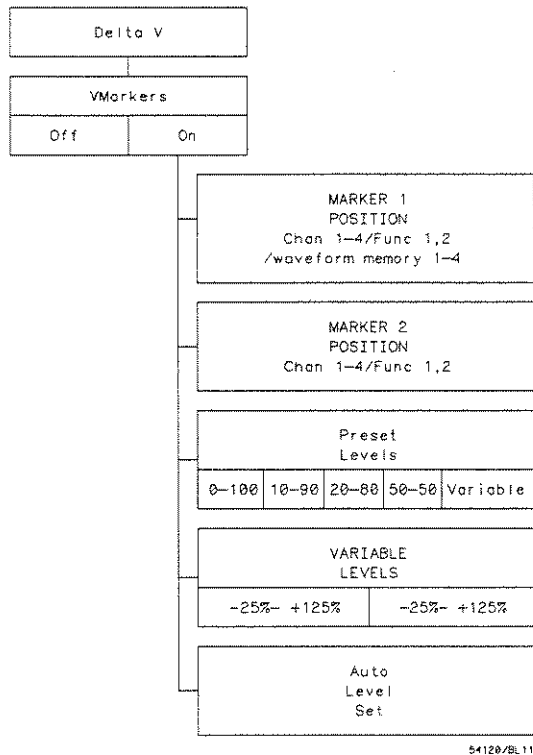

Figure 10-1. Delta V Menu

Voltage Markers

After you have selected the Delta V menu and turned on the voltage markers:

- you can select the source for either of the V markers
- you can position the V markers
- you can reference the voltage markers to any source if the display for that source is on (excluding pixel memories**).

** Refer to "Waveform Save Menu," for more details on the HP 54121T memories

The voltage shown at the top of the waveform display area indicates the voltage level of the selected V Marker.

The voltage marker sources are:

- channels 1 through 4
- functions 1 and 2 (set up in Wfm Math menu)
- waveform memories 1 through 4

Note

Voltage markers can be separately assigned to any of the sources. This feature allows you to make source-to-source voltage measurements.

To be available the source must be turned on.

After assigning the markers to the desired source, the MARKER 1 POSITION and MARKER 2 POSITION function keys allow you to position the markers vertically with the entry devices.

If you are using the default colors, the voltage marker you have selected and its label are orange. ΔV , displayed at the bottom of the display, is the difference between the two markers. If one of the marker position keys is the selected function, the values for ΔV and the voltage level of the selected marker are also orange. The MARKER POSITION key that is not selected and its associated marker are gray.

Preset Levels Key

Pressing the Preset Levels key with both voltage markers assigned to the same source:

- automatically positions the voltage markers with respect to the last 0-100% levels to the following levels:
 - 0-100%
 - 10-90%
 - 20-80%
 - 50-50%
 - Variable

Pressing the Preset Levels key with the voltage markers assigned to different sources provides two preset levels:

- 50-50%
- Variable

Note

In contrast to when both voltage markers are assigned to one source, the voltage markers do not reposition themselves as the variable levels are changed. When the voltage markers are assigned to different sources the Auto Level Set key must be pressed to position the voltage markers to the new variable levels.

Note

The voltage markers will not automatically position themselves on a new signal but will use their previous levels as references until you manually reposition them with the MARKER 1 and 2 controls, or press the Auto Level Set key, which sets the levels according to the current signal. Both of these determine new 0-100% levels.

The automatic preset levels for the voltage markers are useful tools when combined with the time markers. When combined they can be used to make custom measurements and to identify specific signal edges.

Pressing the Preset Levels key repeatedly until Variable is selected:

- adds the VARIABLE LEVELS key to the menu
- provides two variables for defining the levels of the voltage markers the same way the fixed preset levels did

The variable preset levels can be changed with any of the entry devices.

Repeated pressing of the VARIABLE LEVELS key toggles it between the two levels.

Auto Level Set Key

The Auto Level Set key automatically sets the voltage markers to the selected preset levels on the displayed signal(s)

- with the voltage markers assigned to the same source both preset levels are associated with that source
- marker 1 is associated with the first source and marker 2 with the second

Note

If the voltage markers are assigned to a single source and then reassigned, the oscilloscope remembers the voltage levels of the first source. This allows you to reselect the first source without losing the 0-100% reference.

Voltage Marker Exercise

The objective of this exercise is to demonstrate the automatic preset voltage marker levels.

WARNING

Before connecting the HP 54121A test set to a signal source, ensure that the source does not exceed ± 2 V. If the input signal exceeds these limits, PERMANENT DAMAGE to the instrument will result.

Tip

Set the output of the function generator to the appropriate level before connecting it to the HP 54121T.

The equipment required for this exercise includes:

- HP 54121T oscilloscope
- HP 11667B power splitter
- HP 8116A function generator
- miscellaneous SMA and 3.5 mm precision connectors, adapters and cables

Equipment configuration:

- Connect the output of the function generator to channel 1 and trigger inputs of the HP 54121A test set with the power splitter. See figure 10-2. For demonstration purposes, a power splitter is not required if your pulse generator has a separate trigger output to connect to the HP 54121T's trigger input.

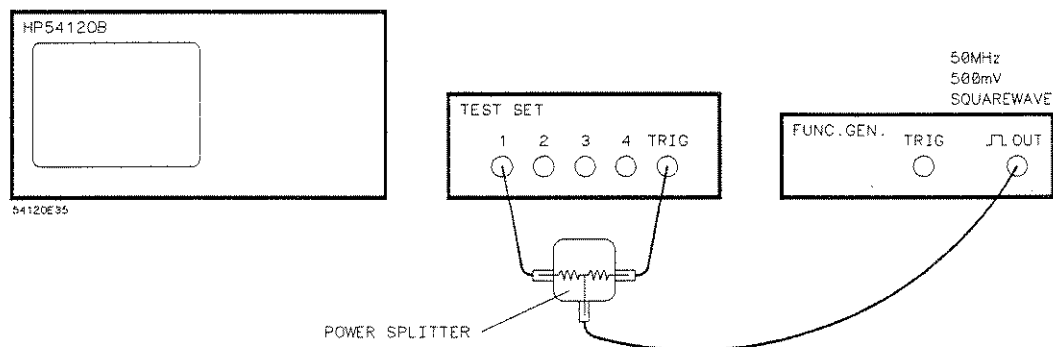
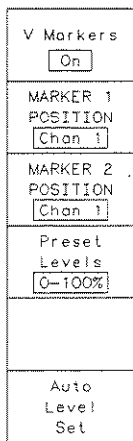

Figure 10-2. Equipment Configuration

Initial Instrument Setup



54120B05

- HP 8116A function generator
 - set for 500 mV, 50 MHz square wave
- HP 54121T oscilloscope
 - press **AUTOSCALE**
 - set **TIME/DIV** = 10 ns/div

Select the Delta V menu:

- turn voltage markers **On**
 - for discrimination marker 2 has twice as many dashes as marker 1
- set **Preset Levels** to 0-100%
- press **Auto Level Set** key

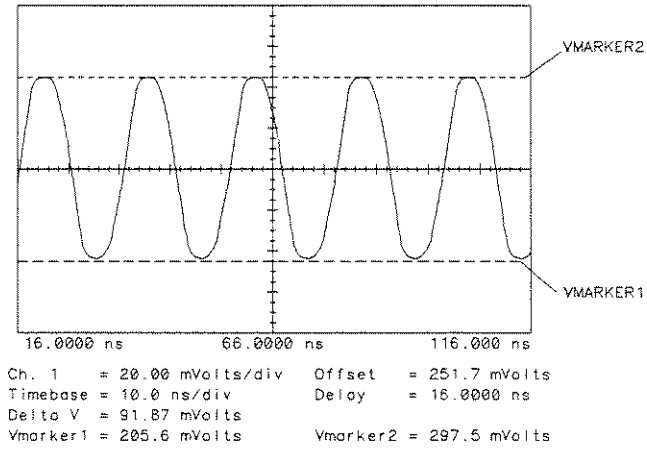

54120K05

Figure 10-3. VMarkers

Pressing the Auto Level Set key automatically moves the voltage markers to the 0-100% levels (preset levels) of the signal. To see how the Preset Levels key works, press the Auto Level Set key to reference the markers to the channel 1 signal, then press the Preset Levels key several times and notice how the markers move to the defined levels.

Voltage Measurement Exercise

The objective of this exercise is to show you how the voltage markers can be used to make differential voltage measurements with two different sources. For example, if you needed to evaluate the amount of voltage shift when a signal is acted upon by a circuit or device under test.

WARNING

Before connecting the HP 54121A test set to a signal source, ensure that the source does not exceed $\pm V$. If the input signal exceeds these limits, PERMANENT DAMAGE to the instrument will result.

Tip

Set the output of the function generator to the appropriate level before connecting to the HP 54121T.

The equipment required for this exercise includes:

- HP 54121T oscilloscope
- HP 11667B power splitter
- HP 8116A function generator
- miscellaneous SMA and 3.5 mm precision connectors, adapters and cables

Equipment configuration:

- Connect the output of the function generator to channel 1 and trigger inputs of the HP 54121A test set with the power splitter. See figure 10-2. For demonstration purposes, a power splitter is not required if your pulse generator has a separate trigger output to connect to the HP 54121T's trigger input.

Initial Instrument Setup

- HP 8116A function generator
 - set for 500 mV, 50 MHz square wave
- HP 54121T oscilloscope
 - press **AUTOSCALE**
 - set **TIME/DIV** = 10 ns/div

Select Wfm Save menu:

- store channel 1 to waveform memory 1
- turn on display of memory 1

Select Delta V menu:

- turn voltage markers **On**
- assign marker 1 to channel 1
- assign marker 2 to memory 1
- select **0-100% preset levels** using **Variable** preset levels
- press the **Auto Level Set** key

This places V Marker 1 to the bottom of channel 1 and V Marker 2 to the top of memory 1. The voltage levels of the two markers are shown at the bottom of the display. Also listed there is ΔV , the difference between the two markers.

Select the Channel menu:

- With **OFFSET** and the knob, move the channel 1 waveform up and down.

Notice that as the channel 1 waveform is moved on the display that **MARKER1** maintains its relationship to channel 1.

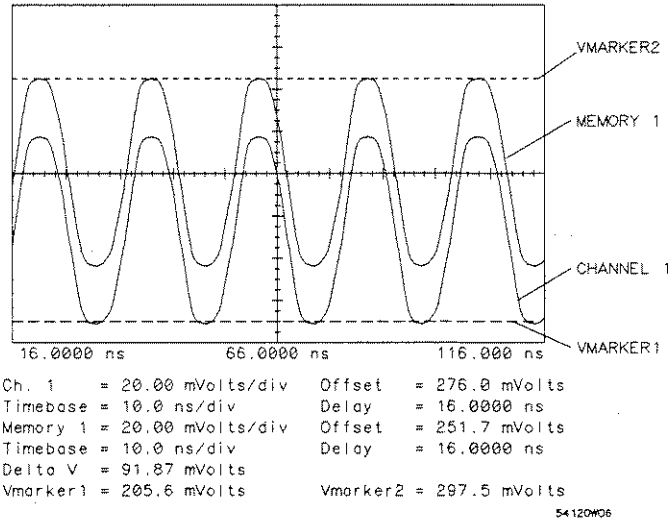
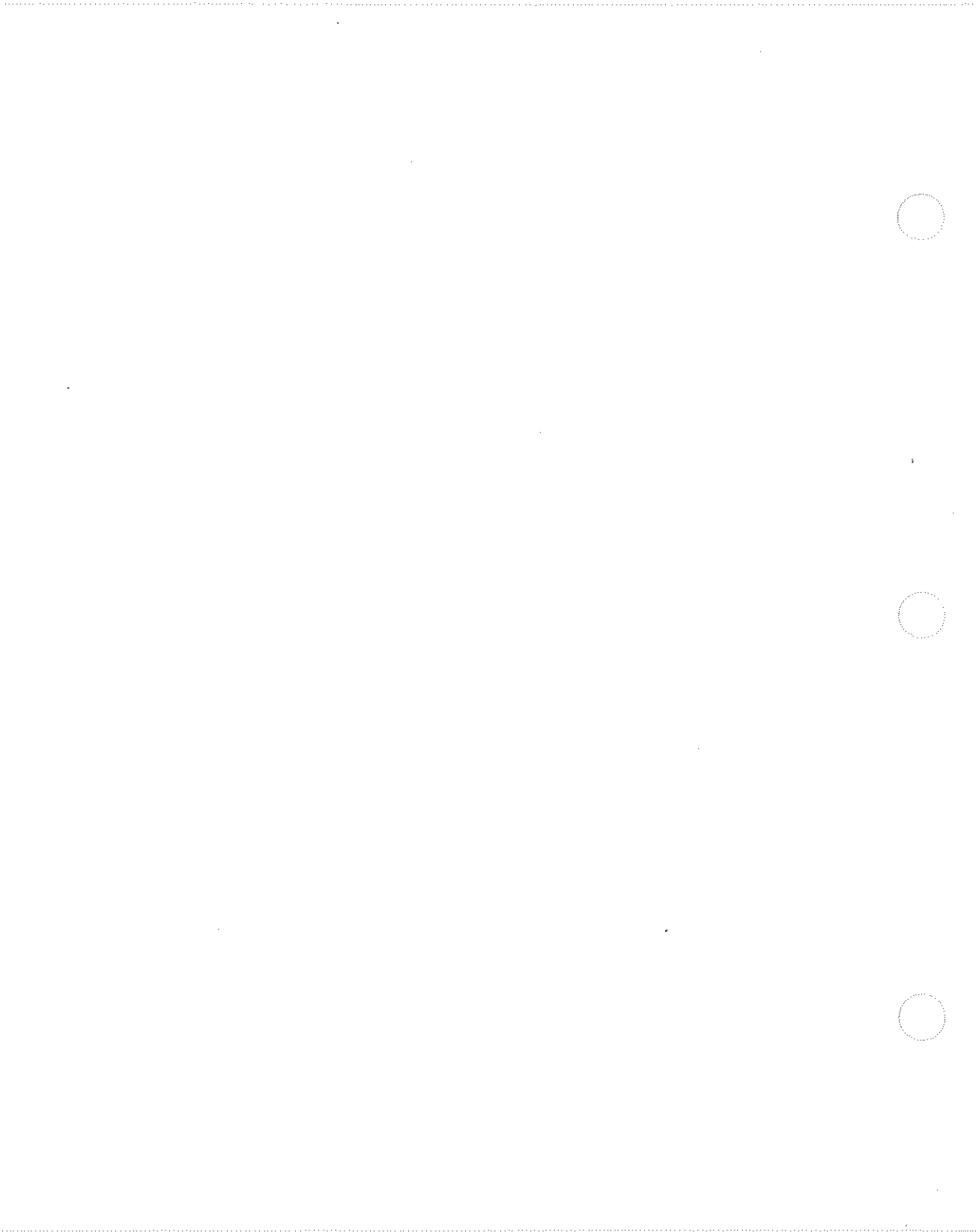

Figure 10-5. Source-to-Source Voltage Measurement

When you assign the two voltage markers to different sources, the HP 54121T oscilloscope recognizes any differences in the VOLTS/DIV and OFFSET values for the two sources. This allows you to make differential voltage measurements between these sources.



Chapter Contents

- the stop and start markers
- how to use the waveform edge finders
- an exercise illustrating how to make a time interval measurement on a single source
- an exercise illustrating how to make a time interval measurement between two sources

Overview

The Delta t function menu controls two calibrated time markers that can be used as references or for making measurements in the time domain. These markers can be positioned with signal edges or time references.

The values of the two markers with respect to the trigger point and to each other (Δt) are displayed at the bottom of the CRT.

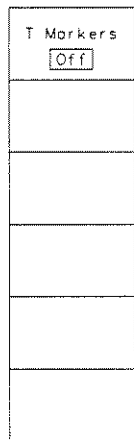

54120B23



54120B05



54120B07

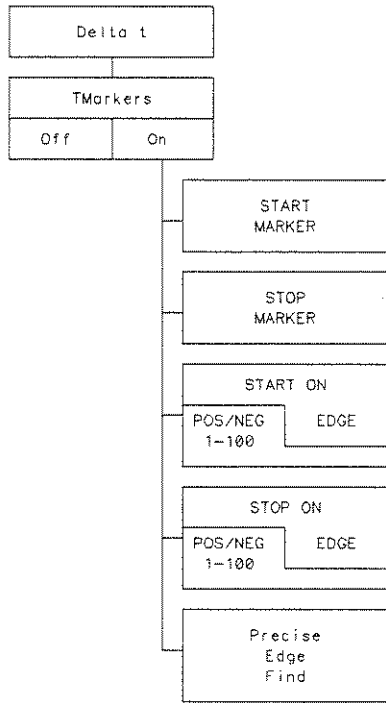

54128/BL 12

Figure 11-1. Delta t Menu

Start and Stop Markers

After you have selected the Delta t menu and turned on the time markers:

- you can move each time marker manually by selecting the START MARKER or STOP MARKER and using the entry devices
 - stop marker has twice as many dashes as the start marker
 - if default colors are used, the selected t marker is displayed in orange

T Markers	<input type="checkbox"/> On
START MARKER	
STOP MARKER	
START ON	<input type="checkbox"/> POS EDGE
	<input type="checkbox"/> 1
STOP ON	<input type="checkbox"/> POS EDGE
	<input type="checkbox"/> 1
Precise Edge Find	

54120967

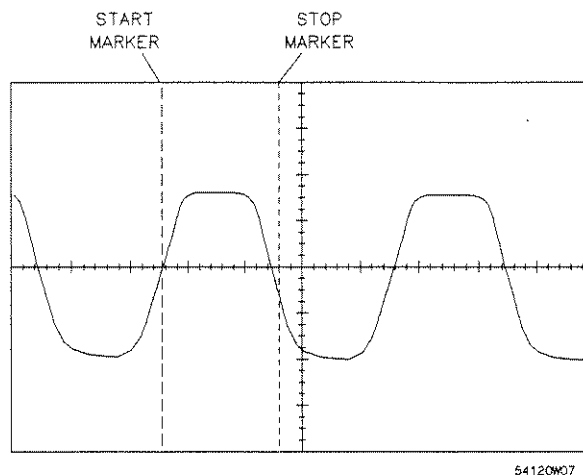

Figure 11-2. T Markers (Waveform)

The Delta t menu includes three additional keys that are only available when the Delta V markers menu is turned on. They include:

- START ON EDGE key
- STOP ON EDGE key
- Precise Edge Find key

Start and Stop on Edge Keys

The START ON EDGE and STOP ON EDGE keys allow you to:

- move the time markers to any on-screen signal edge defined by V Marker level
- select the number of the edge of interest with any of the entry devices
- the edge keys are highlighted in the color of the waveform they are measuring

- If an edge key has been selected and is pressed a second time the polarity of the edge changes
- If the marker is associated with a memory it will use the Time/Div of the memory

The voltage marker levels (set in the Delta V menu) define the intersections of the on-screen signal edges as follows:

- the start-on-edge marker is associated with voltage marker 1 and the stop-on-edge marker is associated with voltage marker 2
- the associated voltage marker must intersect the signal for the start-on-edge and stop-on-edge markers to find the defined edge(s)

Note

To use the start-on-edge and stop-on-edge function, return to the Delta V menu and adjust the voltage markers to intersect the signal of interest.

Precise Edge Find Key

The precise edge find function momentarily expands the edges defined by the time markers and voltage markers to increase the resolution of this measurement.

The Precise Edge Find key allows you to move the time markers to the signal edges defined by the START ON EDGE and STOP ON EDGE keys and the voltage markers.

Tip

Use this key if you have moved the time markers (with the START MARKER and STOP MARKER keys) and you want to return to the edges defined by the edge keys.

When you are in the averaged display mode, the speed, accuracy, and repeatability of this measurement are influenced by the number of averages. The more averages, the greater the repeatability and the slower the measurement will be. Other items that influence repeatability are: input signal edge speed, repetition rate, signal jitter, starting TIME/DIV and delay time.

Time-Interval Measurement Exercise

This exercise demonstrates how to make a time-interval measurement with the Delta t markers.

WARNING

Before connecting the HP 54121A test set to a signal source, ensure that the source does not exceed ± 2 V. If the input signal exceeds these limits, PERMANENT DAMAGE to the instrument will result.

Tip

Set the output of the function generator to the appropriate level before connecting to the HP 54121T.

The equipment required for this exercise includes:

- HP 54121T oscilloscope
- HP 11667B power splitter
- HP 8116A function generator
- miscellaneous SMA and 3.5 mm precision connectors, adapters and cables

Equipment configuration:

- Connect the output of the function generator to channel 1 and trigger inputs of the HP 54121A test set with the power splitter. See Figure 11-3 on the next page. For demonstration purposes, a power splitter is not required if your pulse generator has a separate trigger output to connect to the HP 54121T's trigger input.

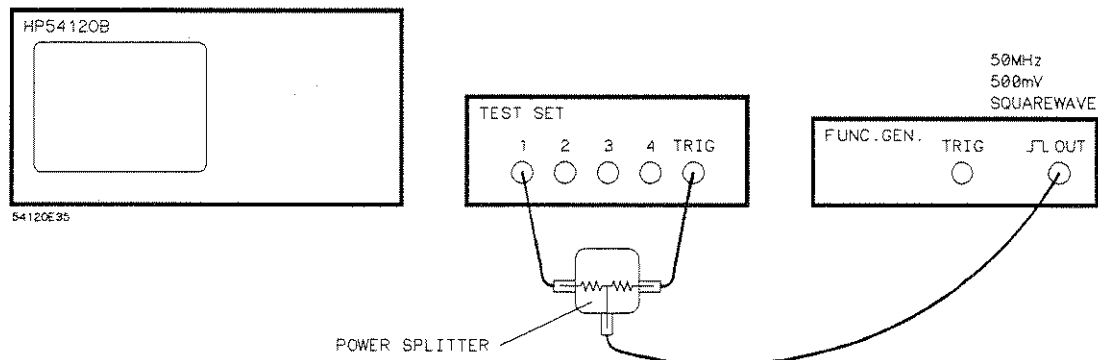

Figure 11-3. Equipment Configuration

Initial Instrument Setup

- HP 8116A function generator
 - set for 500 mV, 50 MHz square wave
- HP 54121T oscilloscope
 - press **AUTOSCALE**
 - set **TIME/DIV** = 20 ns/div
 - select the Delta t menu and turn the time markers **On**
 - with the entry devices move the **START MARKER** to the first negative edge of the signal
 - move the **STOP MARKER** to the second negative edge

Tip

To improve the accuracy of where the time markers are placed, pick a horizontal reference like a graticule line and position the time markers at the intersection of the graticule line and the edges of interest. This is an accurate way to manually position the time markers. In the next exercise you will learn how to position the time markers automatically with the voltage markers.

The value of Δt , listed at the bottom of the display, defines the time between the time markers (in this case the time of one cycle).

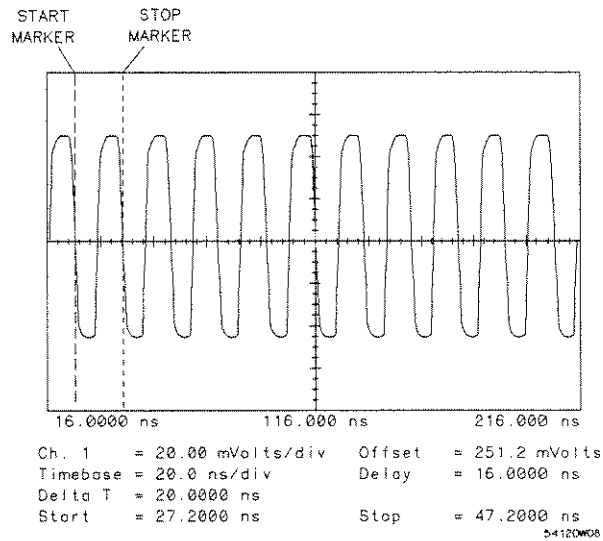

Figure 11-4. Pulse Period

Time Interval Exercise

This exercise demonstrates how to make a time interval measurement from one source to another.

WARNING

Before connecting the HP 54121A test set to a signal source, ensure that the source does not exceed ± 2 V Max. If the input signal exceeds these limits PERMANENT DAMAGE to the instrument will result.

Tip

Set the output of the function generator to the appropriate level before connecting to the HP 54121T.

The equipment required for this exercise includes:

- HP 54121T oscilloscope
- HP 11667B power splitter
- HP 8116A function generator
- 20 dB coaxial attenuator
- miscellaneous SMA and 3.5 mm precision connectors, adapters and cables

Equipment configuration:

- Connect the output of the function generator to channels 1 and 2 of the HP 54121A test set with the power splitter.
- Use an additional length of cable between the power splitter and channel 2 to provide a time differential between channels 1 and 2.
- Connect the trigger output of the function generator through a 20 db attenuator (10:1) to the trigger input of the HP 54121A.

Note

For the purposes of this exercise additional cabling is used for the channel 2 signal path. This induces a time differential between channels 1 and 2. The objective of this exercise is to measure this differential. The technique in this exercise can be used to determine the propagation delay of a device under test.

Tip

Connect one output of the power splitter directly to the channel 1 input and connect channel 2 to the power splitter with a coax cable. This will provide the delay needed for this exercise.

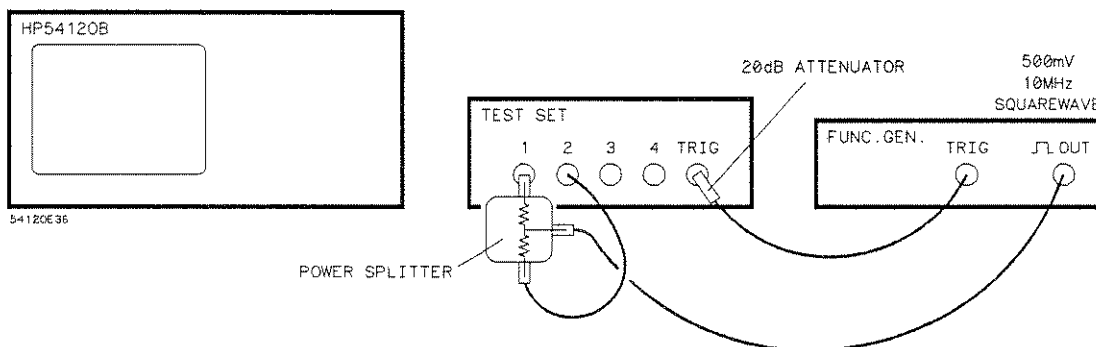

Figure 11-5. Equipment Configuration

Initial Instrument Setup

- HP 8116A function generator set for 500 mV, 50 MHz square wave
- HP 54121T oscilloscope
 - press **AUTOSCALE**
 - set **TIME/DIV = 2 ns/div**
 - select the Display menu and set the **Screen** function to **Single**
 - select the Delta V menu and turn the voltage markers **On**
 - assign marker 1 to channel 1 and marker 2 to channel 2
 - set **Preset Levels = 50-50%** and press **Auto Level Set**
 - select the Delta t menu and turn the time markers **On**
 - set **START ON EDGE = POS 1** and **STOP ON EDGE = POS 1**
 - press **Precise Edge Find**

This sets the start and stop markers on the leading edges of the pulses on channels 1 and 2 respectively. The accuracy of the placement of the time markers is enhanced by the fact that they are placed with the voltage markers and the selected edges to identify the point of intersection.

The time interval between the time markers is listed at the bottom of the display labeled Δt . See figure 11-6 on next page.

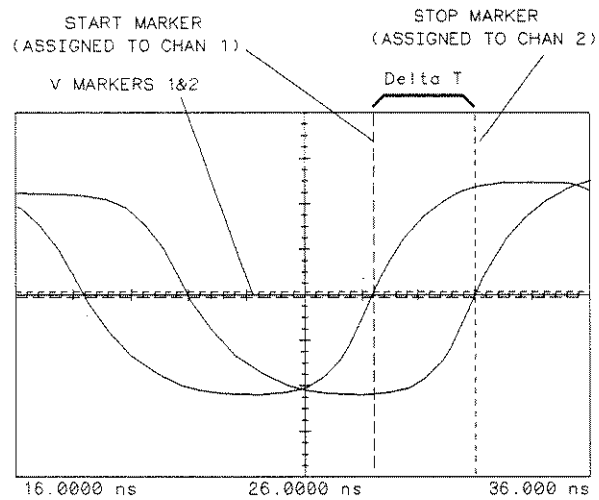

Ch. 1	= 20.00 mVolts/div	Offset	= 251.7 mVolts
Ch. 2	= 20.00 mVolts/div	Offset	= 252.2 mVolts
Timebase	= 2.00 ns/div	Delay	= 16.0000 ns
Delta T	= 3.7526 ns		
Start	= 28.4414 ns	Stop	= 32.1940 ns
Delta V	= 1.250 mVolts		
Vmarker1	= 251.2 mVolts	Vmarker2	= 252.5 mVolts

54120W09

Figure 11-6. Source-to-Source Time Interval Measurement

Chapter Contents

- built-in math functions, which allow you to:
 - invert
 - add
 - subtract
 - determine minimum or maximum data or both (Min, Max)
 - define a math function as a channel or memory (Only)
 - provide X vs Y display using two operands (Versus)
- tips on how to use the Min and Max capabilities
- an exercise demonstrating Waveform Math features and how to subtract one source from another
- how to scale a function

Overview

The Wfm (Waveform) Math menu allows you to

- define functions 1 and 2 with the waveform memories 1 through 4 and channels 1 through 4 as operands

A Waveform Math function is created by:

- adding or subtracting one operand from another (+, -)
- inverting an operand (Invert)
- acquiring minimum or maximum data from an operand (Min and Max)
- defining an operand as a function (Only)
- using two operands to generate X vs Y display (Versus)

Note

The minimum and maximum operators are available only when the HP 54121T is in the persistence display mode.

A function can be:

- displayed
- evaluated with the HP 54121T's automatic measurements
 - not valid for Versus operator
- stored in one of the waveform memories for later use
 - not valid for Versus operator
- rescaled and offset vertically

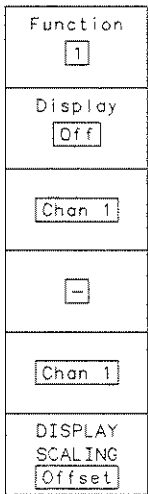

54120B24

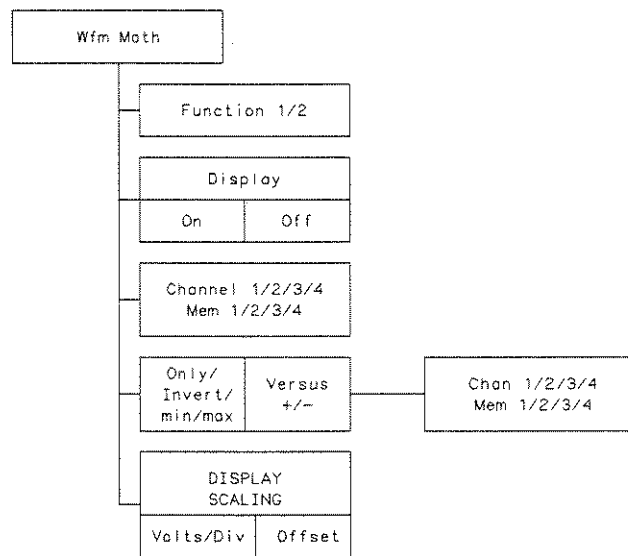

54120/BL13

Figure 12-1. Waveform Math Menu

**Function Select
Key**

The Function select key allows you to:

- access either function 1 or 2.

**Display On/Off
Key**

The Display On/Off key allows you to:

- turn the display for the selected function on and off
 - if a function is turned on, its vertical deflection factor is displayed at the bottom of the CRT
 - if both functions are displayed, both deflection factors are displayed
 - if you want to display function 1 and channel 1 or function 2 and channel 2 at the same time, use the Only operator

**First Operand
Key**

The first operand key (third key from top) allows you to:

- select the first operand with either
 - memory 1 through 4 or
 - channel 1 through 4

Note

These sources do not have to be on to be used as operands.

**Operation Select
Key**

The operation select key (fourth key from the top) allows you to:

- select one of the following operations
 - " + " adds the two operands
 - " - " subtracts the second operand from the first
 - "Invert" inverts the first operand and eliminates the second operand key
 - "Only" defines the first operand as the function and allows you to add offset to signals beyond what is possible with the hardware
 - "Min" defines the selected function as the minimum value in each of the 501 horizontal time buckets of the first operand, and is valid only in the persistence display mode**

- "Max" defines the selected function as the maximum value in each of the 501 horizontal time buckets of the first operand and is valid only in the persistence display mode**
- "Versus" displays two operands (X vs Y) on a Cartesian coordinate with the first and second operands the Y and X values respectively

*** To acquire a meaningful display when using the min or max operators, do not use infinite persistence (set in the Display menu). If infinite persistence is used all data points remain on the display indefinitely and the min and max data cannot be discerned.*

Second Operand Key

The second operand key (fifth key from the top) allows you to:

- select the second operand
- your choices are
 - channel 1 through 4
 - memory 1 through 4
 - valid with the " + ", " - ", and "Versus" operators only

Display Scaling Key

The Display Scaling Key (bottom key) allows you to:

- change volts/div and offset of the displayed function with any of the entry devices
- pressing the DISPLAY SCALING key toggles it between:
 - Volts/div
 - Offset

Tip

Waveform math functions are not allowed as an operand. However, if it would be an advantage to use a function as an operand, store the function to a waveform memory and use that memory as an operand.

Waveform Math Exercise

The object of this exercise is to demonstrate some capabilities of the Waveform Math menu and the ability of DISPLAY SCALING to magnify portions of a waveform.

WARNING

Before connecting the HP 54121A test set to a signal source, ensure that the source does not exceed ± 2 V. If the input signal exceeds these limits, PERMANENT DAMAGE to the instrument will result.

Tip

Set the output of the function generator to the appropriate level before connecting to the HP 54121T.

The equipment required for this exercise includes:

- HP 54121T oscilloscope
- HP 8116A function generator (or equivalent)
- HP 11667B power splitter
- 20 dB coaxial
- miscellaneous SMA and 3.5 mm precision connectors, adapters and cables

Equipment configuration:

- Connect the output of the function generator to channel 1 and 2 with the power splitter. See figure 12-2 on the next page.
 - To induce a time differential between the two channels connect one output of the power splitter directly to channel 1. Connect channel 2 to the other output of the power splitter with a coax cable.

- Connect the trigger output of the function generator to the trigger input of the HP 54121A through a 20 dB attenuator.

Note

For the purposes of this exercise additional cabling is used for the channel 2 signal path. This induces a time differential between channels 1 and 2 so there is enough difference between the signals on channels 1 and 2 to demonstrate the features of the Waveform Math menu.

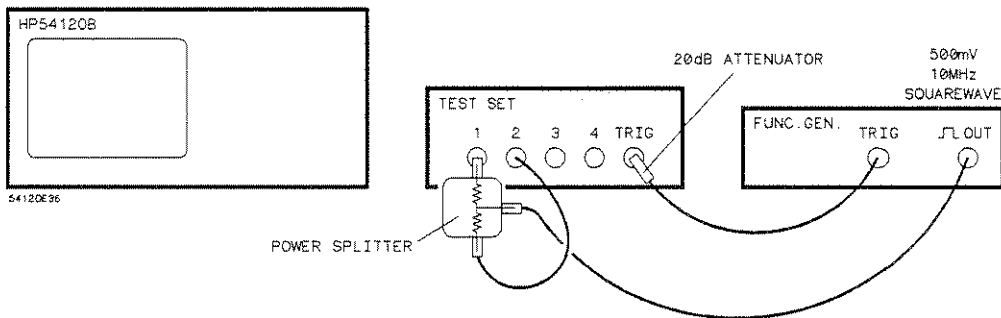

Figure 12-2. Equipment Configuration

Initial Instrument Setup

- HP 8116A function generator
 - set for 500 mV p-p, 10 MHz square wave
 - set OFFSET = 500 mV
- HP 54121T
 - press **AUTOSCALE**
 - select **Wfm Math** (Waveform Math) menu
 - set Function 1 = Chan 1 – (minus) Chan 2

This causes the HP 54121T to algebraically subtract channel 2 from channel 1.

- set **Function 1 Display On**

The resulting display should resemble figure 12-3. Function 1 is the top signal. The perturbations on function 1 occur because channel 2 has been delayed with respect to channel 1. In duplicating this exercise we used 4.8 ns delay, a one-meter coax cable.

To keep this data for future reference, you can store function 1 in one of the waveform memories. If you want to characterize this function, you can select the Measure menu and use any of its automated measurements.

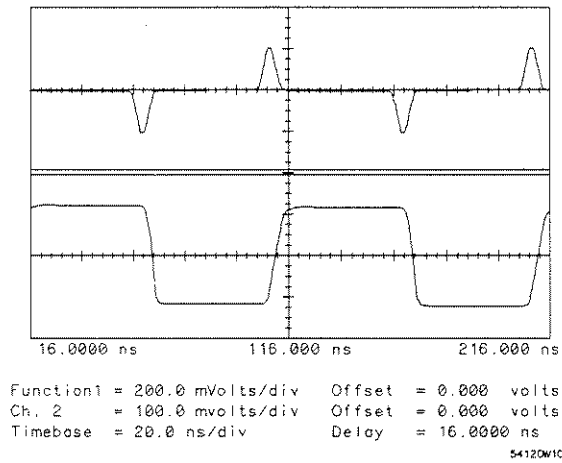

Figure 12-3. Function 1 = Chan 1 - Chan 2

Using the Only Operator

Using the "Only" operator may let you view a signal at higher sensitivity levels than would be possible if you tried to evaluate a signal directly from one of the channel inputs. Perform the following steps to demonstrate this feature.

- connect a 500 mV p-p square wave to channel 1 & the external trigger input with an HP 11667B power splitter
- press **AUTOSCALE**
- select the Waveform Math menu and turn **Function 1** on
- set Function 1 = Chan 1 only

This defines function 1 as channel 1 and displays both waveforms at center screen.

- Use the **DISPLAY SCALING** Offset and move function 1 down until the top of the waveform is at center screen.

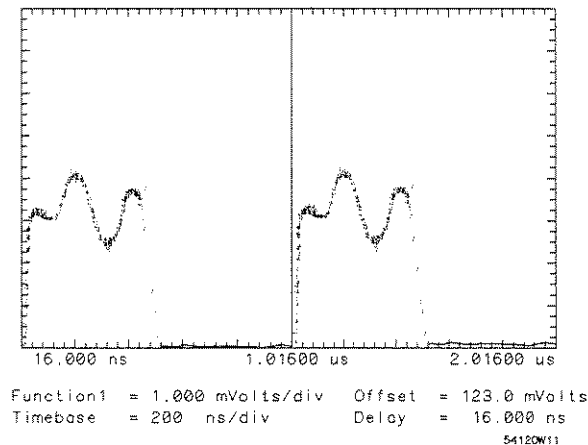

Figure 12-4. Using the Only Operator

- Use the DISPLAY SCALING Volts/div and change the sensitivity for function 1 to 1 mV/div
- Set DISPLAY SCALING Offset to 750 mV. You may have to use the knob and adjust the display scaling offset slightly to vertically center the top of the signal.

The square wave from the function generator was intentionally offset 500 mV for this exercise. Because the OFFSET function on the Channels menu has a maximum offset of 500 mV, the top of the signal can not be centered vertically on the display. The additional offset available from the Only operator allowed the maximum (1 mV/div) vertical sensitivity to be used to evaluate this sample signal.



Chapter Contents

- the automatic waveform measurements

Overview

The Measure menu is your access to the HP 54121T's 11 automatic measurements. You can measure all 11 waveform parameters simply by pressing a key, or if you prefer, you can select each measurement individually. These automatic measurements conform to the IEEE standard 194-1977, "IEEE Standard Pulse Terms and Definitions."

You can document the results of the measurements with either an HP-IB printer or plotter.

After you have selected the Measure menu, you can select any of the three Measure menus by pressing the More key.

Peak-to-Peak Voltage	+Width	Measure Chan 1
Preshoot	-Width	Precision Fine
Over-Shoot	Duty Cycle	All
RMS Voltage	Rise Time	Freq
	Fall Time	Period
More	More	More

54120B25 54120B08 54120B09

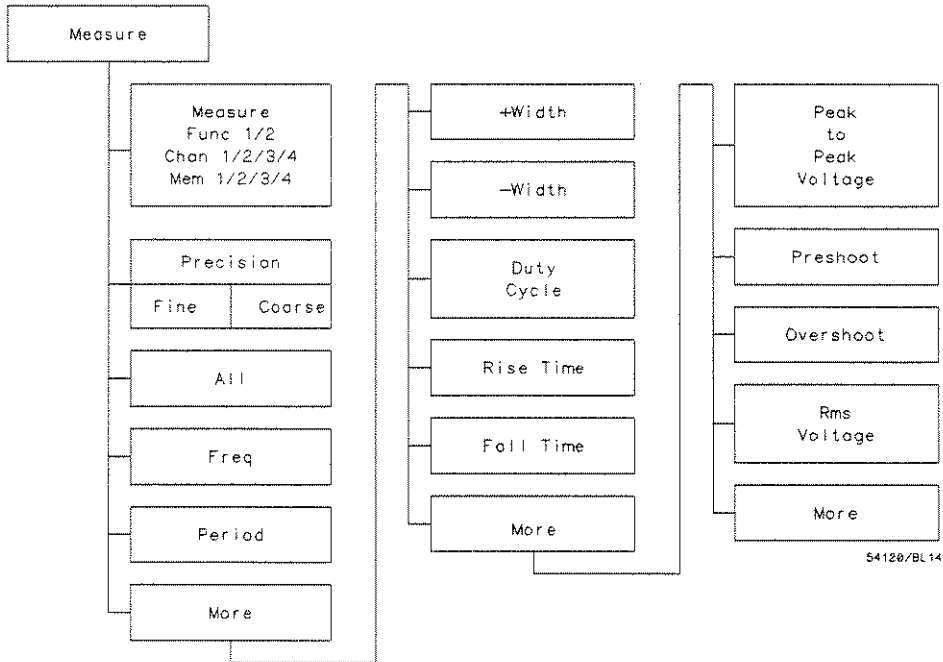

Figure 13-1. Measure Menu

Measure Key

The Measure key (top key) allows you to:

- select the waveform source to be measured
 - channel 1-4
 - memory 1-4
 - function 1 or 2

Note

To measure a source, it must be turned on (displayed).

Precision Key

The Precision key allows you to optimize your automated measurements for either increased throughput or resolution.

It allows you to select:

- coarse precision
 - uses data on screen to determine results
 - provides highest level of throughput
- fine precision
 - acquires new data to determine results
 - provides highest level of resolution
 - signal is momentarily expanded in time

The HP 54121T can make either fine or coarse precision measurements. Coarse measurements are made with displayed data and require less time to complete than do fine measurements. Fine measurements rescale the timebase and acquire new data for improved measurement resolution.

Coarse measurements are made when:

- data acquisition has been stopped
 - Stop key is pressed
- you make a
 - peak-to-peak voltage
 - preshoot
 - overshoot or
 - RMS voltage measurement
- you measure a waveform memory
- you measure a waveform math function that uses a waveform memory as an operand
- coarse precision is selected

All Key

Pressing the All key:

- causes the HP 54121T to automatically make the measurements listed below and displays the results at the bottom of the CRT. The measurement results are highlighted in the same color as the measured source.

Freq (Frequency)	+ Width (50%)	Peak-to-Peak Voltage
Period	- Width (50%)	Preshoot
	Duty Cycle	Overshoot
	Rise Time (10-90%)	RMS Voltage
	Fall Time (90-10%)	

Peak-to-Peak Voltage
Preshoot
Over-Shoot
RMS Voltage
More

54120825

+Width
-Width
Duty Cycle
Rise Time
Fall Time
More

54120868

Measure Chan 1
Precision Fine
All
Freq
Period
More

54120869

Any of these measurements can be made independently by pressing the appropriate key.

When a measurement is made, the voltage and time markers are automatically placed on the signal. The points where the markers intersect the signal indicate the data points for making the measurement.

If the parameters for making a particular measurement are not present, the measurement will not be made.

If measurements are made independently, the last measurement result is highlighted in the same color as the measured source while any previous measurement results are displayed in gray.

$$V_{rms} = \left[\frac{1}{n} \sum_{j=1}^{j=n} v_j^2 \right]^{\frac{1}{2}}$$

MS10001

Where there are n time buckets in 1 period and V_j is the voltage at bucket j of the period data. Since it is rare for a period to fall precisely within an integral number of time buckets, the algorithm rounds to the nearest time bucket at the beginning and end, and uses these as the limits.

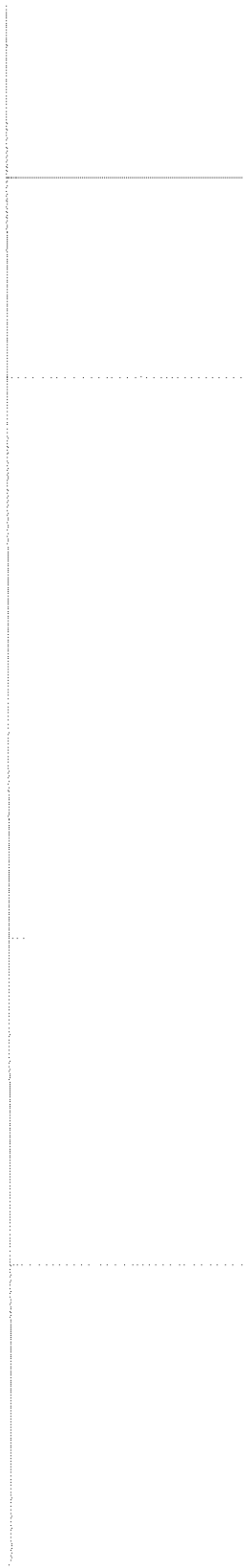

.....

Chapter Contents

- how to use the Network menu
- exercises that show you how to make reflection and transmission measurements
- an exercise that shows you how to normalize a waveform

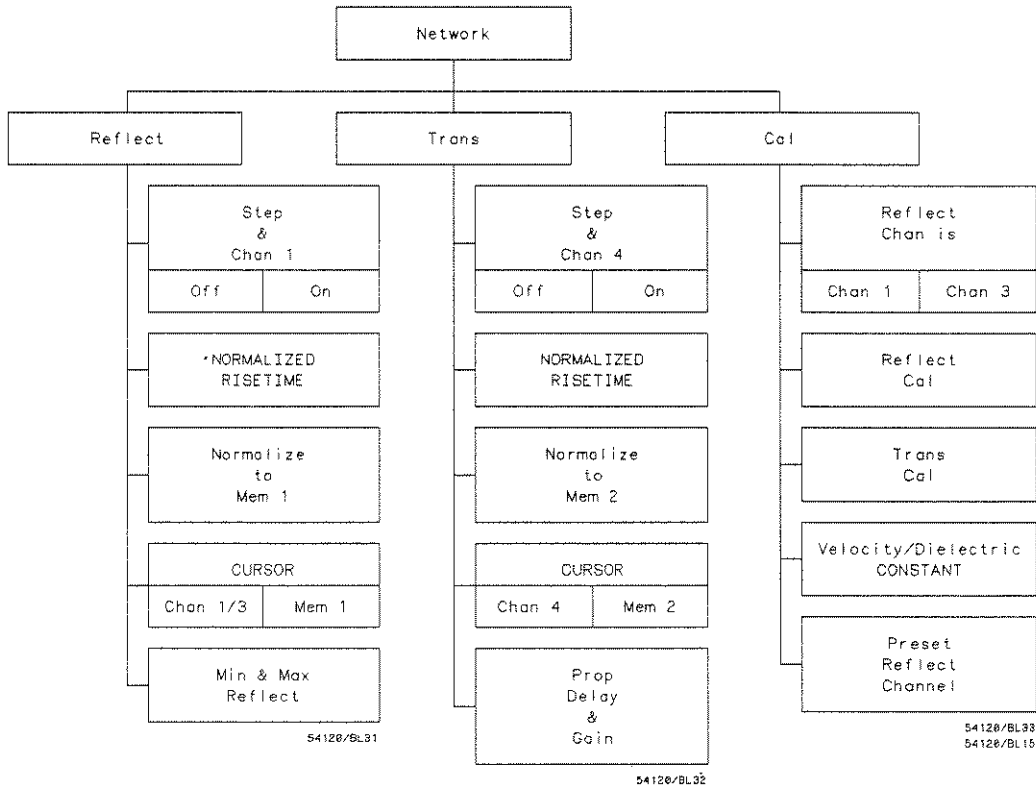

Figure 14-1. Network Menu Schematic

Overview

The Network menu gives you the ability to make time domain reflection and transmission measurements with an internal or external pulse. You can also quantify transmission and reflection parameters automatically by pressing the appropriate keys.

The transmission and reflection calibration sequences establish the $0\ \Omega$ and $50\ \Omega$ levels and the reference plane for determining automated answers such as propagation delay and gain, and minimum and maximum reflection.

To make time domain reflection measurements (TDR), use the Reflect submenu, and to make time domain transmission (TDT) measurements, use the Trans submenu. Each of these submenus provide control for the:

- Internal pulse
- Calibrated cursor
- Normalization process
- Automated measurements

Normalization gives you a powerful tool for characterizing the response of transmission paths or networks to a variable risetime pulse. This characterization is accomplished mathematically and gives you the ability to evaluate a device under test (DUT) with a pulse with a simulated rise time as fast as 10 ps. Normalization also corrects for imperfect cables and connectors between the oscilloscope and the DUT.

Making a TDR measurement is a three step process:

- adjust time/div and delay to obtain a display of the point of interest
- establish references for automatic measurements with the Reflect Cal function on the Cal submenu
- analyze the DUT with the Reflect submenu
 - the cursor provides instantaneous values
 - minimum and maximum reflections are available with a key stroke
 - simulated rise times and error correction are available with normalization

Note

Normalization uses the Bracewell transform, which is under license from Stanford University.

Making a transmission measurement is a three step process:

- adjust time/div and delay to obtain a display of the point of interest
- establish references for automatic measurements with the Trans Cal function on the Cal submenu
- analyze the DUT with the Trans submenu
 - the cursor provides instantaneous values
 - propagation delay and gain are available with a key stroke

Additional information on the use of TDR can be found in appendices C, D, and E

Cal Submenu

Cal
Reflect Trans Cal
Reflect Chan 1 Chan 1
Reflect Cal
Trans Cal
Velocity Dielect CONSTANT
Preset Reflect Channel

54120826

The Cal submenu:

- allows you to calibrate the HP 54121T to make reflection (TDR) or transmission (TDT) measurements
- must be completed before the cursor or normalization can be used, or automatic network measurement answers are available
- is valid for current TIME/DIV, DELAY, and bandwidth settings when normalization is used
- is valid for the existing external configuration only
- is valid for all VOLTS/DIV and OFFSET settings

Note

The TIME/DIV, DELAY, and bandwidth settings that were used during the cal procedure must be used for normalization. These settings may be changed, but if you intend to use normalization you must either recal at the new settings or return to the original TIME/DIV DELAY, and bandwidth values.

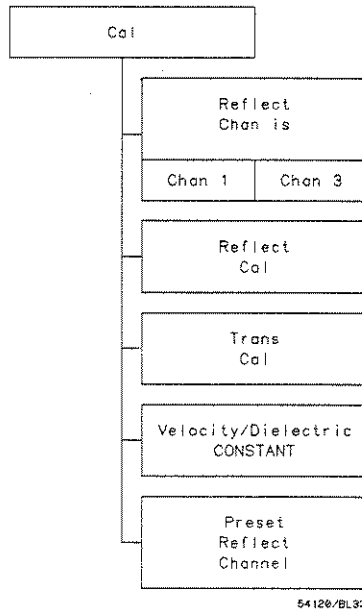

Figure 14-2. Cal Submenu Schematic

Tip

For the best calibration results, move the incident edge off screen by increasing the Timebase DELAY. However, ensure the reflected edge is still on screen after you have adjusted the DELAY.

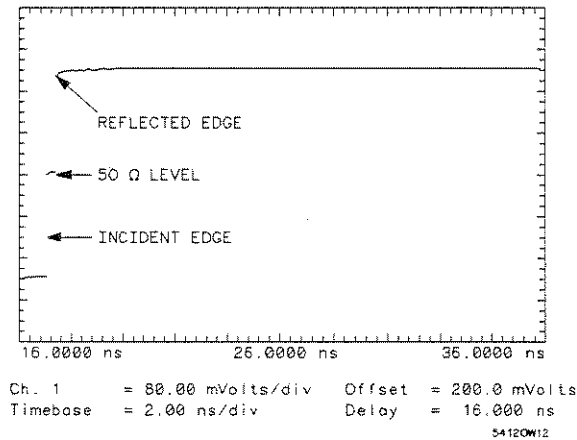

Figure 14-3. Internal Step

Reflect Channel Is Key

The Reflect Channel Is key:

- defines the input for making reflection measurements
 - channel 1 is used for the internal step
 - channel 3 is used with an external step (must be synchronized with the internal step)
 - channel 3 is used as the input if it is necessary to attenuate the internal step for a specific application
- interacts with Preset Reflect Channel key
 - if channel 1 is selected, the Preset Reflect Channel key is activated
 - if channel 3 is selected, the Preset Reflect Channel key is deactivated

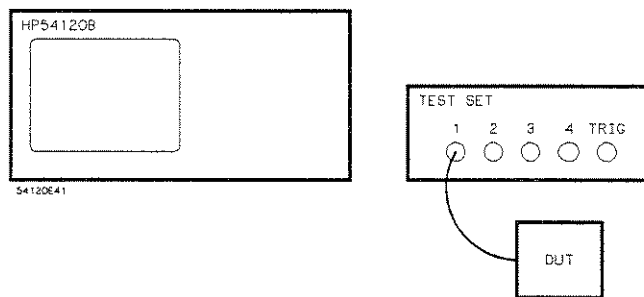

Figure 14-4. TDR Measurement

Using an External Pulse for TDR

An external pulse source is useful for measurements of very long cables where the internal step would be absorbed by the cable under test. Another use would be the testing of devices that change impedance with signal amplitude or offset.

To use an external signal source, channel 3 must be selected as the reflection channel and the external source must be synchronized with the internal step of the HP 54121T. Refer to figure 14-5. The external pulse source must have a $50\ \Omega$ input impedance and a 200 mV sensitivity.

Note

The pulse generator's width must be less than the TDR step's period

Caution

Ensure the signal applied to the HP 54121A does not exceed $\pm 2\ V$, or permanent damage to the test set will result.

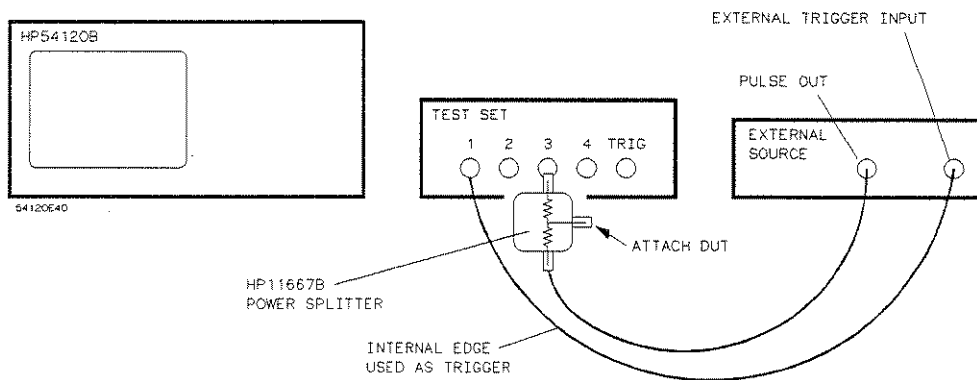

Figure 14-5. TDR Using an External Pulse Source

Using an External Attenuator for TDR

If it is necessary to attenuate the internal step for making TDR measurements, channel 3 must be selected as the reflection channel and the equipment configuration should resemble figure 14-6.

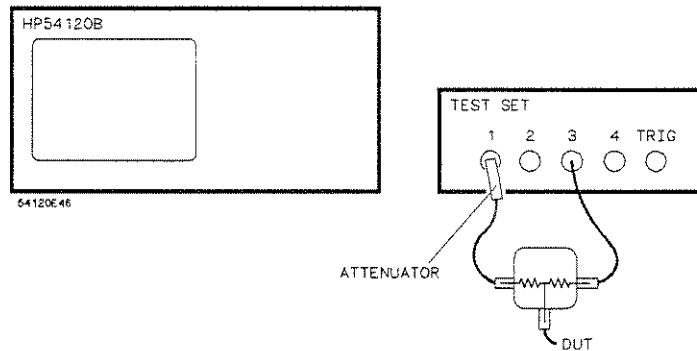

Figure 14-6. TDR with Attenuated Internal Step

Reflect Cal Key

The reflect cal is a two-step process that asks you to sequentially install a $0\ \Omega$ (short) and a $50\ \Omega$ termination at the reference plane in place of the DUT. The reference plane is the point in the circuit where the DUT will be installed when the reflection measurements are made. Prompts are provided to help you complete the calibration.

The Reflect Cal key allows you to define:

- $0\ \Omega$ (short) reference
 - establishes the time and step height reference for the cursor, automatic answers, and normalization
- $50\ \Omega$ reference
 - establishes the impedance reference for the cursor and automatic answers

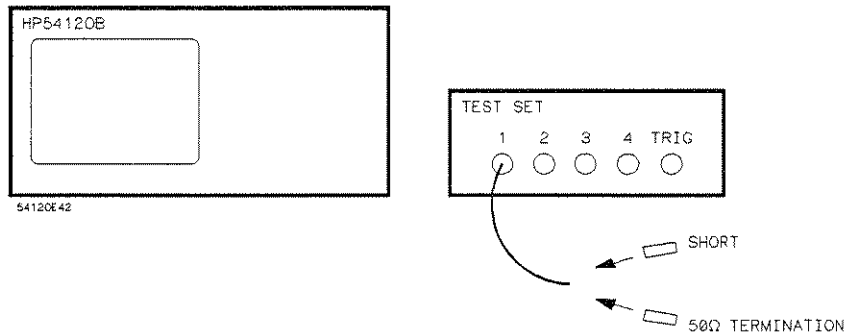

Figure 14-7. Reflect Cal

Note

When you perform a reflect cal in the averaged display mode, you don't have to wait for the display to integrate to its new levels. When the reflect cal key is pressed, the display is cleared and new data is acquired for the calibration.

The display mode influences the speed, accuracy and repeatability of reflect and trans cal, as it influences other HP 54121T features. If accuracy and repeatability are more important than speed, use the averaged display mode. The more averages you use, the more accurate and repeatable the results. If throughput and speed are the most important issues, use fewer averages or the persistence display mode.

Note

If your measurement requires a 10 ps normalized risetime (fastest available), the oscilloscope's environment must be stable. You must allow approximately four hours for its operating temperature to stabilize.

Make sure the step generator is on during the warm-up.

If you perform a reflect or transmission cal with a large number of averages without an adequate warm-up, measurement accuracy may suffer. The greater the number of averages, the more opportunity for timing drift. In other words, a larger number of samples may in fact decrease accuracy if the temperature of the instrument is not fully stabilized.

Noise is a significant problem when you're trying to normalize to 10 ps risetime. To compensate for the effect of noise, use a minimum of 64 averages.

For best results with a 10 ps normalized risetime and 2048 averages, a four-hour warm-up is suggested. If you use 256 averages a one-half hour warm-up is adequate.

If you are using faster normalization times, use the 20 GHz bandwidth mode.

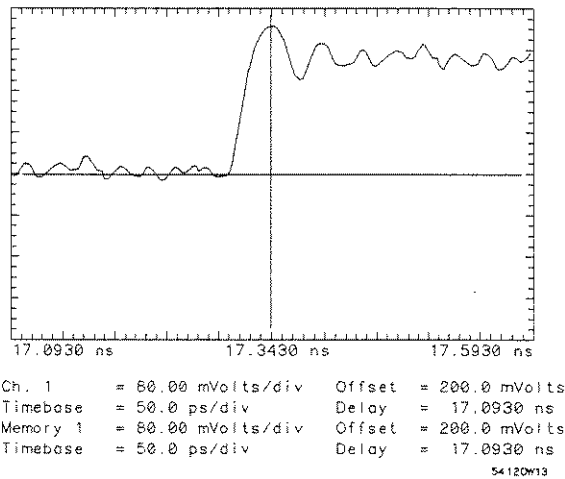

Figure 14-8. Instability Caused by Low Number of Averages When 10 ps Normalized Risettime Is Used

The Reflect Cal:

- must be completed for a reflection measurement to be valid
- must be completed before the cursor and normalization can be used and automatic reflection answers are available
- is only valid at current bandwidth setting for normalization
- is only valid at current DELAY time setting for normalization
- is only valid at current TIME/DIV setting for normalization
- is only valid for the current external configuration
- is valid for all VOLTS/DIV and OFFSET settings

Trans Cal Key

The trans cal is a two-step process that evaluates the pulse height and the reference path.

Pressing the Trans Cal key:

- allows you to determine the signal through the reference path and the step height for making transmission path measurements
- must be completed for transmission path measurements to be valid
- must be completed before the cursor and normalization can be used and automatic transmission answers are available

A Trans Cal is valid for:

- the current TIME/DIV, DELAY, and bandwidth
- the current external configuration for normalization
- for all VOLTS/DIV and OFFSET settings
- for all TIME/DIV, DELAY, and bandwidth settings for the cursor and prop delay & gain on the live channel

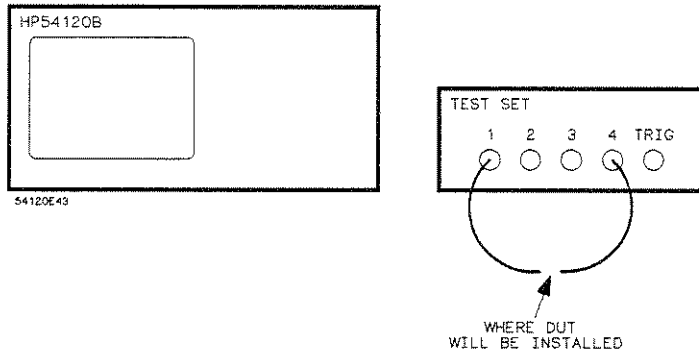

Figure 14-9. Transmission Cal

Velocity/Dielectric Constant Key

When velocity constant is selected:

- you can set time/metre for making distance measurements with TDR and TDT
- you can set the velocity constant from 3.336 ns/meter to 33.356 ns/meter
- the velocity constant interacts with the relative dielectric constant and vice-versa; the relationship is:

$$\text{relative dielectric constant} = \frac{\text{velocity of light in free space}^2 \text{ i.e., } 3 \times 10^8 \text{ meters/second}}{\text{velocity of electromagnetic waves in the dielectric media}}$$

and:

$$\text{velocity constant} = \frac{(\text{relative dielectric constant})^{1/2}}{\text{velocity of light in free space}} \\ \text{i.e., } 3 \times 10^8 \text{ metres/second}$$

where:

$$\text{velocity constant} = \frac{1}{\text{velocity of electromagnetic waves in the dielectric media}}$$

Note

The distance measurements available with the HP 54121T are only as accurate as the dielectric constant or velocity constant that you enter.

When relative dielectric constant is selected:

- you can set the relative dielectric constant for making distance measurements with TDR and TDT
- you can set the relative dielectric constant from 1 to 100
- the relative dielectric constant interacts with the velocity constant

Distance measurements can be affected by many variables including the uniformity of the material.

Table 14-1. Dielectric Constants

Material	Dielectric Constant ϵ_r
Air (1 atm)	1.0
Vacuum	1.0
Teflon	2.1
Polyethelene	2.3
Polysterene	2.6
Glass	4.0 - 8.4
Phenolic laminates	4.2 - 5.5
Porcelain	5.7 - 6.8
Alumina	9.7

To improve accuracy, measure the propagation velocity of a representative sample of a given material.

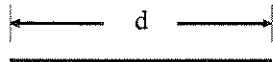

$$1/V = t/d \text{ (one way)}$$

Where:

V = velocity

t = time

d = distance

The following demonstration shows how to determine the velocity constant of a 36-inch (0.9144 m) Gore cable with the answers associated with the cursor on the Reflect menu:

1. Do a Reflect cal using the channel 1 input as the reference plane.
2. Attach the 36-inch (0.9144 m) Gore cable to channel 1. This cable is supplied with the HP 54121T.
3. Move the cursor to the unterminated end of the Gore cable i.e., the beginning of the reflected edge. See Figure 14-10.

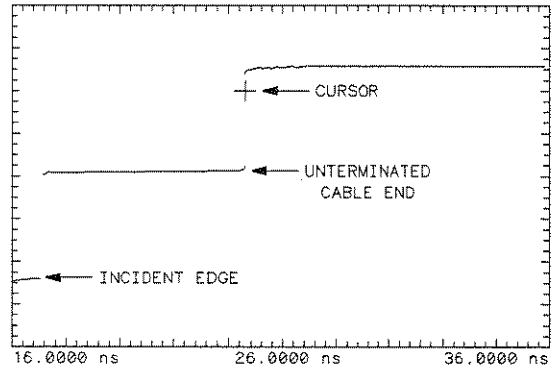

Ch. 1 = 80.00 mVolts/div Offset = 200.0 mVolts
 Timebase = 2.00 ns/div Delay = 16.0000 ns
 Cursor on Channel 1 at 7.2272 ns from reference plane
 Ref Plane = 17.3728 ns Distance = 914.8 mmeters
 Rho = 60.53 % Impedance = 203 Ohms
 54120W14

Figure 14-10. Measuring 36-Inch Gore Cable

Note

Set the cursor as close to the 50% level of the reflected edge as possible. Decreasing the TIME/DIV setting gives you increased resolution for moving the cursor.

Δt lists the propagation delay from the reference plane to the cursor and back – i.e., two-way time. In this example $\Delta t = 7.2178$ ns.

Using a ratio:

$$7.2272 \text{ ns} / 0.9144 \text{ m (36 inches)} = \text{two-way time} / 1 \text{ metre} = 7.90 \text{ ns}$$

therefore:

$$\text{one-way time/metre} = 7.90 \text{ ns} / 2$$

$$\text{one-way time/meter} = 3.95 \text{ ns} = \text{Velocity Constant}$$

- Return to the Cal menu and enter 3.9467 ns for the velocity constant.

Note

The value for the dielectric constant will automatically be changed to match the new value for the velocity constant (1.3999).

- Return to the Reflect menu and notice that the cursor values now reflect the actual length of the cable – i.e., 914 mm.

Preset Reflect Channel Key

Pressing the Preset Reflect Channel key:

- sets the oscilloscope so that it displays the internal step that is used for making reflection measurements
- is activated when reflect channel = 1
- when pressed the Preset key:
 - turns step & Chan 1 On (reflect portion of the Network menu)
 - sets Chan 1 VOLTS/DIV to 80 mV/div
 - sets Chan 1 OFFSET = 200 mV
 - turns Chan 1 on
 - turns Chan 2 and 3 off
 - sets TIME/DIV = 2 ns/div
 - sets DELAY = 16 ns
 - sets Delay Ref at Left
 - sets timebase sweep to Freerun
 - sets screen mode to single
 - turns functions 1 and 2 off

Note

Pressing the Preset Reflect Channel key is a convenient way to put the oscilloscope in a known state. Any time you need to use the internal TDR pulse, this preset key saves time.

Reflect Submenu

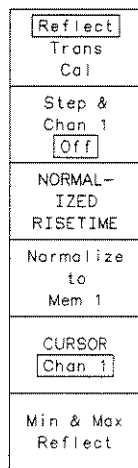

54120B27

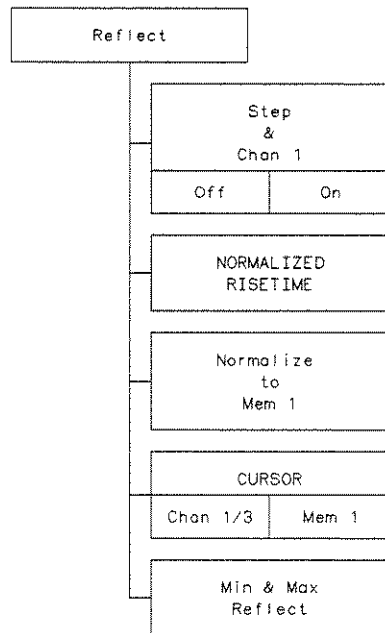

54120/BL31

Figure 14-11. Reflect Submenu Schematic

The Reflect submenu allows you to:

- make reflection measurements with an external or internal step source
 - external step source must be synchronized with the internal step

When the Reflect submenu is selected:

- the function keys are reassigned to reflection functions

Step & Chan 1/3 Key

Pressing the Step & Chan 1/3 key:

- toggles channel 1 or 3 off or on in unison with the step from channel 1
- turns the display for channel 1 or 3 on or off in unison with the step from channel 1
 - Channel 1 or 3 is selected with the Reflect Chan key in the Network Cal menu
- turns associated normalized memory off when Step & Chan is turned off
- sets oscilloscope to freerun sweep mode when Step & Chan is turned on

Normalized Risetime Key

Normalization allows you to eliminate sources of error from the measurement and evaluate the device under test (DUT) with a signal similar to the one used in the DUT's actual application.

When the measured waveform is normalized to a specific risetime the actual step function is not changed but the reflection from the device under test (DUT) is mathematically transformed to show what its response would be to a "perfect" step with the specified risetime. The current value for the normalized risetime is listed at the top of the display when you are in the Reflect or Trans submenus.

Note

In order for you to use normalization, a Reflect or Trans Cal must first be completed with the TIME/DIV, DELAY, bandwidth, and external configuration set for the measurement. If any of these three parameters are changed, the cal must be repeated. If you return the TIME/DIV, DELAY, bandwidth, and external configuration to their original conditions, you may use normalization without recalibrating.

Selecting the NORMALIZED RISETIME key:

- allows you to enter the desired normalized risetime with the entry devices
- acceptable values for normalized risetime vary with the value of TIME/DIV
 - minimum normalized risetime = (TIME/DIV)/12.5 or 10 ps whichever is greater
 - maximum normalized risetime = 5 X TIME/DIV
- causes the oscilloscope to list the risetime at the top of the display
- no action is taken until the Normalize to Memory key is pressed

Normalize to Mem 1 Key

When you press Normalize to Mem 1:

- the oscilloscope calculates the DUT's response to a pulse with a defined risetime
- the normalized waveform is stored to waveform memory 1
- waveform memory 1 is turned on and the normalized waveform is displayed – if default colors are used, waveform memories are blue
- cursor can be assigned to Mem 1
- status line indicates "Normalizing"

Cursor Key

When you press the Cursor key:

- a cursor appears on the displayed signal
 - the cursor can be moved horizontally with any of the entry devices
- a prompt at the top of display tells the location of the cursor with respect to the trigger event
- you can assign the cursor to the selected channel (1 or 3) or memory 1
 - to have the cursor assigned to a source, the source must be on and valid
- waveform factors, calculated at the cursor location, are displayed in the upper left of the display – they include:
 - Δt = time from the reference to the cursor and back (two-way time)
 - d = distance from the cursor to the reference plane (one-way distance) based on the entered dielectric or velocity constant

Rho = instantaneous percent reflection
Z = impedance, calculated from the 50 Ω and 0 Ω levels established in the reflect cal

Note

The cursor is updated as it moves on the waveform; therefore, if the waveform changes the cursor will not move to the new waveform level until the cursor is repositioned.

Min & Max Reflect Key

When you press the Min & Max Reflect key:

- the minimum and maximum percent reflection for the data on screen is displayed in the upper left corner
 - the source for the data is the selected source for the cursor

Note

Before pressing the Min & Max Reflect key you must complete a reflect cal. The oscilloscope uses the 50 Ω and 0 Ω (short) reference levels established in the cal procedure to calculate the min and max values. The algorithms for calculating the min and max reflect percentages are:

$$\text{Min reflect percentage} = \frac{V_{\text{min}} - V_{\text{ref } 50 \Omega}}{V_{\text{ref } 50 \Omega} - V_{\text{ref } 0 \Omega}}$$

$$\text{Max reflect percentage} = \frac{V_{\text{max}} - V_{\text{ref } 50 \Omega}}{V_{\text{ref } 50 \Omega} - V_{\text{ref } 0 \Omega}}$$

Where: V_{min} = minimum voltage on TDR waveform

$V_{\text{ref } 50 \Omega}$ = 50 Ω reference level from reflect cal

$V_{\text{ref } 0 \Omega}$ = 0 Ω reference level from reflect cal

V_{max} = maximum voltage on TDR waveform

Reflect (TDR) Exercise

This exercise demonstrates how to use the internal TDR step to make a reflect measurement. This exercise also shows you how to use normalization and how to acquire the automatic answers provided with the cursor and min and max reflect functions.

The equipment required for this exercise includes:

- HP 54121T oscilloscope
- miscellaneous SMA and precision connectors and cables
- coaxial 50 Ω termination
- coaxial short

Equipment configuration:

- Connect a one-metre cable to the channel 1 input of the HP 54121A.

Note

The SMA cables provided with the oscilloscope in the RF accessory kit are actually 36 inches long – i.e. 0.9144 metres long.

Initial Instrument Setup

HP 54121T:

- Select the Network menu.
- Select the Cal submenu and press the **Preset Reflect Channel** key.

This turns on the TDR step and presets the display.

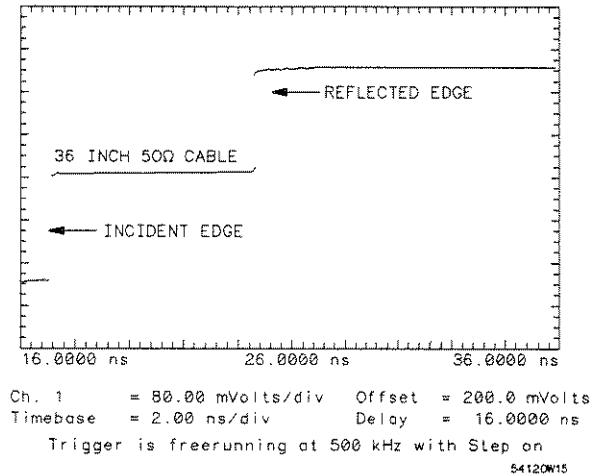

Figure 14-12. TDR Step

- Use a 3.5 mm short and a 50 Ω termination to complete a reflect cal (use the end of the cable on channel 1 as the reference plane).

This provides reference levels for the cursor, the min and max reflect percentages, and normalization.

- Select the Reflect submenu and press the Cursor key.

This places the cursor on the waveform and allows you to use the entry devices to position the cursor. The time from the trigger event to the cursor is listed at the top of the display and the other cursor factors are listed in the waveform display area. As the cursor is moved on the waveform, the factors provide instantaneous values for the current cursor location.

- Alternately install the 50 Ω termination and short and notice the results on the waveform.

This turns on the TDR step and presets the display.

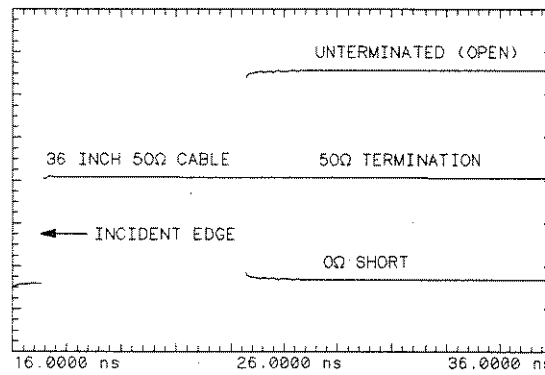

Ch. 1 = 80.00 mVolts/div Offset = 200.0 mVolts
 Timebase = 2.00 ns/div Delay = 16.0000 ns
 Trigger is freerunning at 500 kHz with Step on
 54120M16

Figure 14-13. TDR Step with Various Terminations

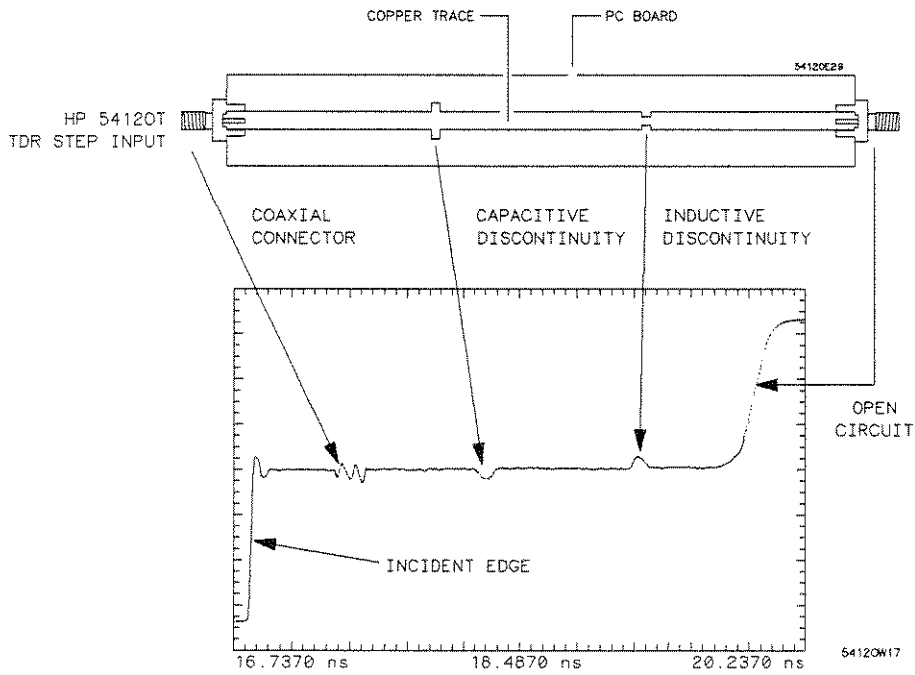

Figure 14-14. TDR Step with a Strip Line

Normalizing Exercise

This exercise demonstrates how to use normalization when you are making a TDR measurement. Normalizing allows you to simulate the response of a device under test (DUT) to various risetime pulses while mathematically eliminating many potential sources of error. In this exercise an unterminated cable end is used to demonstrate the effects of normalization.

The equipment required for this exercise includes:

- HP 54121T oscilloscope
 - miscellaneous SMA and precision connectors and cables
- coaxial Ω termination
- coaxial short

Equipment configuration:

- Connect a one-metre cable to channel 1 of the HP 54121A.

Initial Instrument Setup

HP 54121T:

- Select the Display menu.
 - Set the Display Mode to averaged and select 64 averages.
- Select the Network menu.
- Select the Cal submenu and press the **Preset Reflect Channel** key.

This turns on the TDR pulse and presets the display.

- Set **TIME/DIV** = 1 ns/div.
- Set **Delay Ref at Center**.
- Increase the **DELAY** until the reflected step is at center screen.

Tip

Use the axis graticule and align the leading edge of the reflected pulse with the center graticule. This puts the area of interest at center screen.

Set **TIME/DIV** to 200 ps/div.

This expands the reflected edge and leaves it at center screen.

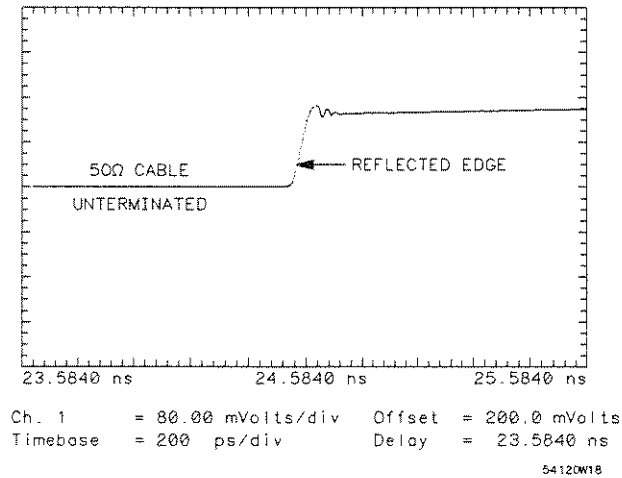

Figure 14-15. Reflected Edge

Note

Ensure the oscilloscope has reached its normal operating temperature before using 16 ps normalized risetime.

- Return to the Network menu and perform a reflect cal.
- Select the Reflect submenu and set the **NORMALIZED RISETIME** to 16 ps.
- Press the **Normalize to Mem 1** key.

This causes the oscilloscope to mathematically simulate the application of a 16 ps risetime step to the unterminated cable end and to store the results in waveform memory 1. The normalized waveform will be displayed in blue.

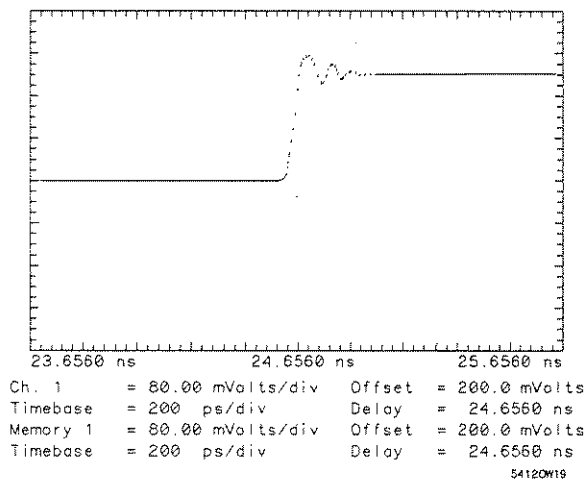

Figure 14-16. Reflected Edge Normalized to 16 ps Risetime Stimulus

Tip

If you would like to evaluate the normalized waveform without the channel 1 display on screen, press the STOP and CLEAR DISPLAY system control keys sequentially. This removes the channel 1 display without disturbing waveform memory 1. To acquire new data and redisplay channel 1, press the RUN key.

- Press the **RUN** key and the channel 1 display returns.
- Set **NORMALIZED RISETIME** = 1 ns and press the **Normalize to Mem 1** key.

Notice the difference between the two normalized waveforms. They demonstrate the simulated reflections from the DUT (unterminated cable end) when two "perfect" but different risetime edges are applied.

This exercise shows an effective way of evaluating a DUT. This is accomplished by simulating conditions similar to those in an actual circuit.

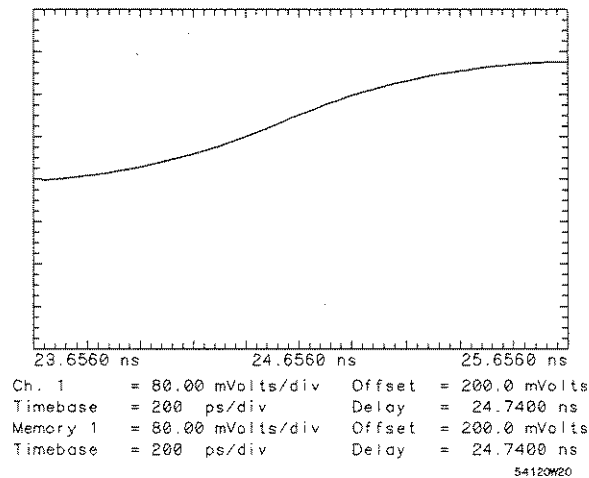
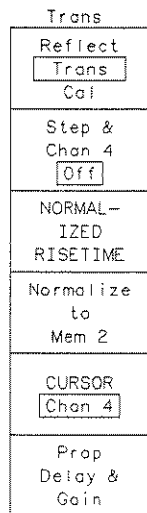

Figure 14-17. 1 ns Normalized Waveform

Trans Submenu

The Trans (Transmission) submenu gives you the capability of evaluating the effect of a device under test (DUT) on a known pulse. The HP 54121T provides a high quality 200 mV pulse that can be used for making transmission measurements. This internal pulse works well for most transmission measurements because the rise time is < 35 ps and the pulse top has a flatness specification of 1% after 1 ns.

The Trans submenu provides control of the internal pulse and transmission channel (channel 4). It also provides access to the calibrated cursor and automated answers such as propagation delay and gain.



54120B28

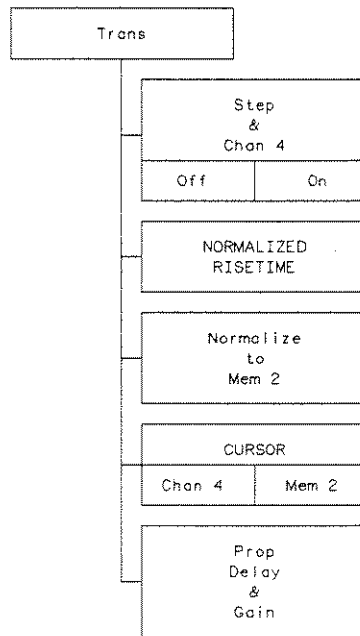

54120/BL32

Figure 14-18. Transmission Submenu Schematic

The Transmission submenu allows you to:

- evaluate the effect of a DUT on an internal or external signal
 - external step source must be synchronized with the internal step

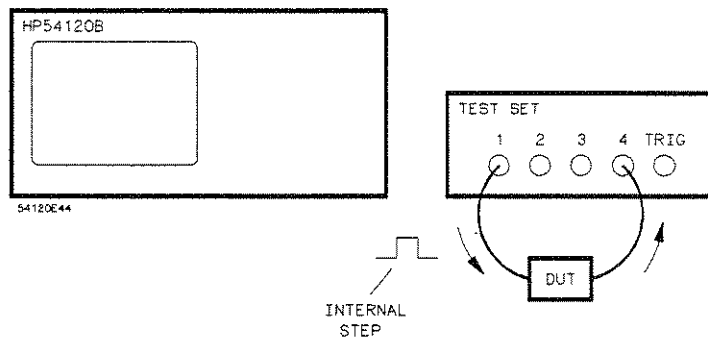

Figure 14-19. Transmission Measurement

When the Trans submenu is selected:

- the function keys are reassigned to transmission functions
- Chan 4 is selected as the transmission measurement input

Step & Chan 4 Key

Pressing the Step and Chan 4 Key:

- allows you to turn Chan 4 on and off
 - turns off the unused reflect channel (channel 1 or 3) when channel 4 is turned off
 - transmission channel is channel 4
 - when channel 4 is turned off, all other channels are left on
- allows you to turn the step on or off if the step was not already on in the Reflect submenu

Normalized Risetime Key

Normalization allows you to eliminate sources of error and to evaluate the device under test (DUT) with a signal similar to the one used in the DUT's actual application.

When the risetime is normalized, the actual step function is not changed but the signal from the device under test (DUT) is mathematically transformed to show what its response would be to a "perfect" step with the normalized risetime.

Note

To use the normalize function, you must complete a trans cal at the desired TIME/DIV, DELAY, bandwidth, and external configuration for the measurement.

When you press the NORMALIZED RISE TIME key:

- you can enter the desired normalized risetime with the entry devices
- acceptable values for normalized risetime vary with the TIME/DIV value
 - minimum normalized risetime = (TIME/DIV)/12.5 or 10 ps whichever is greater
 - maximum normalized risetime = 5 X TIME/DIV setting

Normalize to Mem 2 Key

When you press the Normalize to Mem 2 key:

- the normalized waveform is stored to waveform memory 2
- waveform memory 2 is turned on and the normalized waveform is displayed – if default colors are used, memories will be blue
- cursor can be assigned to waveform memory 2
- status line indicates "Normalizing"

Cursor Key

When you press the Cursor key:

- a cursor appears on the displayed signal
- waveform factors are displayed in the upper left of the display
 - Δt = time from the reference established during the transition to the cursor. If the cursor was set at the 50% level of the edge, Δt would equal the propagation delay
 - Gain = V_{out}/V_{in} (expressed in percentage)
- normalized data will determine waveform factors if a normalized risetime is used

Prop Delay and Gain key

When you press the Prop Delay and Gain key:

- the propagation delay (Prop Delay) of the DUT is displayed
- the distance (d) represented by the prop delay is displayed based on the entered dielectric or velocity constant
- the voltage gain (V_{out}/V_{in}) is displayed

Note

When you are using the cursor, the value of Gain is an instantaneous value calculated at the cursor. When you press the Prop Delay and Gain key, the value of Gain is calculated by using a histogram of the data of the selected source. If you switch from the cursor to the prop delay and gain function, you will probably see a difference between the gain values.

Transmission (TDT) Exercise

This exercise demonstrates how to make (TDT) Time Domain Transmission measurements with the pulse from channel 1. This pulse is passed through the DUT and measured. The results are used to calculate the automated answers for the TDT measurements which include propagation delay, gain, and distance through the DUT.

This exercise also shows you how to use waveform normalization. Normalization can be used to simulate the passing of different risetime steps through the DUT. This allows you to simulate the effects of a DUT on various risetime edges.

An external pulse can be used to make TDT measurements, however the internal pulse works well for these types of measurements because of its 35 ps risetime and 1% flatness.

The equipment required for this exercise includes:

- HP 54121T oscilloscope
- miscellaneous SMA and precision connectors and cables
- coaxial 50 Ω termination
- coaxial short
- coaxial 20 dB attenuator

Equipment configuration:

- Connect a one-metre cable to channel 1 of the HP 54121A.

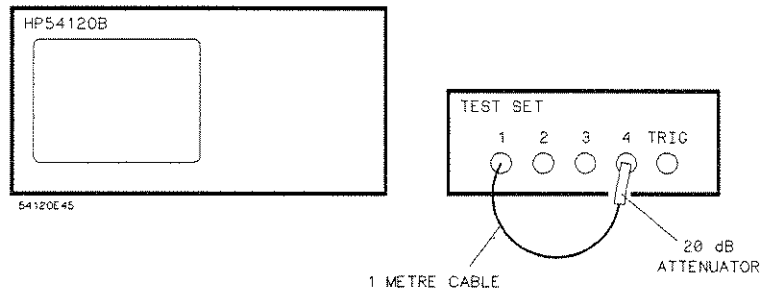

Figure 14-20. TDT Exercise Equipment Configuration

Initial Instrument Setup

HP 54121T:

- Select the Network menu.
- Select the Cal submenu and press the **Preset Channel** key.

This turns on the TDR pulse and presets the display.

- Do a Trans Cal.
- Install the 20 dB attenuator between the cable and the channel 4 input. The 20 dB attenuator is used as the DUT.

Note

You may substitute another attenuator in this exercise but the results will vary accordingly.

- Press the Cursor key.

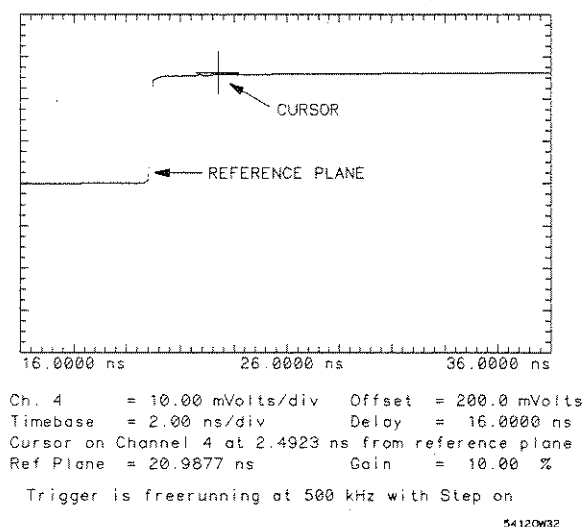

Figure 14-21. Cursor on a Transmission Waveform

This assigns the cursor to the signal on channel 4. After a waveform normalization, the cursor can be assigned to either channel 4 or waveform memory 2.

Notice, as the cursor is moved on the waveform, the value of Δt changes. The value of Δt is the time from the reference established in the trans cal to the cursor.

The value of Gain is the ratio of the output voltage of the DUT to the input voltage. If you use a 20 dB attenuator, the gain value (with the cursor on top of the pulse) is approximately 10%.

- Set **NORMALIZED RISETIME** = 10 ns and press **Normalize to Mem 2** key.
- Set **NORMALIZED RISETIME** = 160 ps and press **Normalize to Mem 2** key.

These last two steps simulate the effect of the DUT on two different risetime edges. They are the slowest and fastest normalized risetimes available at this TIME/DIV setting.

After normalization the cursor can be assigned either to waveform memory 2 or channel 4.

- Press the **Prop Delay and Gain** key.

This provides the propagation delay, distance, and gain associated with the DUT for the cursor key source. The distance factor is calculated with the velocity/dielectric constant from the Cal submenu. The accuracy of the distance factor depends on the accuracy of the velocity/dielectric constant that you enter.

Note

For the instantaneous gain (gain associated with the cursor) and overall gain (gain associated with the Prop Delay and Gain key), a portion of the base of the transmission signal must be displayed. This level of the base is used as a reference for calculating the gain percentage.

Using an External Pulse for TDT

Variable amplitude and offset can be obtained by use of an external pulse source as a stimulus which is triggered by the HP 54121A's TDR step generator. Refer to figures 14-22 and 14-23. The external pulse source must have a 50 Ω input impedance and a 200 mV sensitivity (like an HP 8112A).

Note

The pulse generator's width must be less than the TDR step's period

Caution

Ensure the signal applied to the HP 54121A does not exceed $\pm 2 V$, or permanent damage to the test set will result.

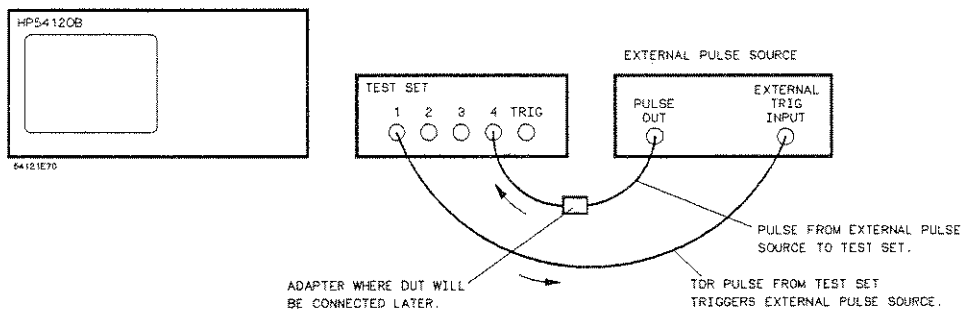

Figure 14-22. Thru Cal Using External Pulse Source

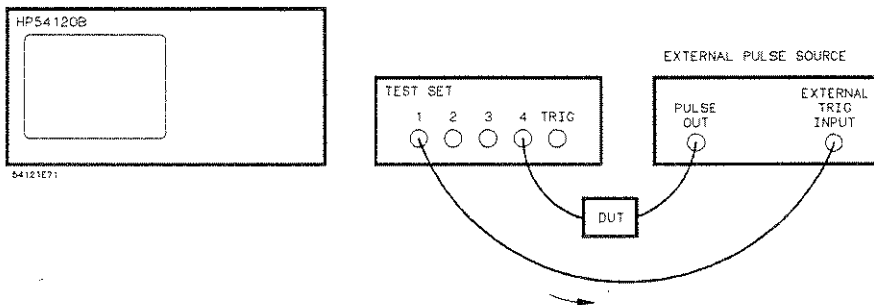
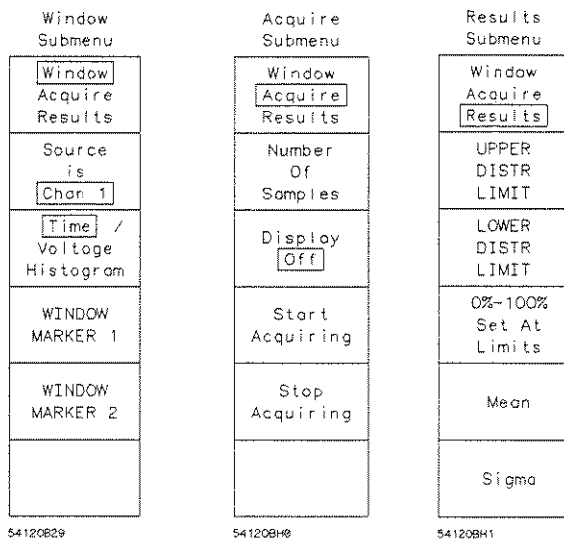

Figure 14-23. TDT Transmission Test Using External Pulse Source

Chapter Contents

- how to use the time and voltage histograms
- an exercise demonstrating how to make time and voltage histograms and use the limit markers to customize your mean and sigma measurements
- an exercise demonstrating how to make a jitter measurement and evaluate the results

Histogram Menu



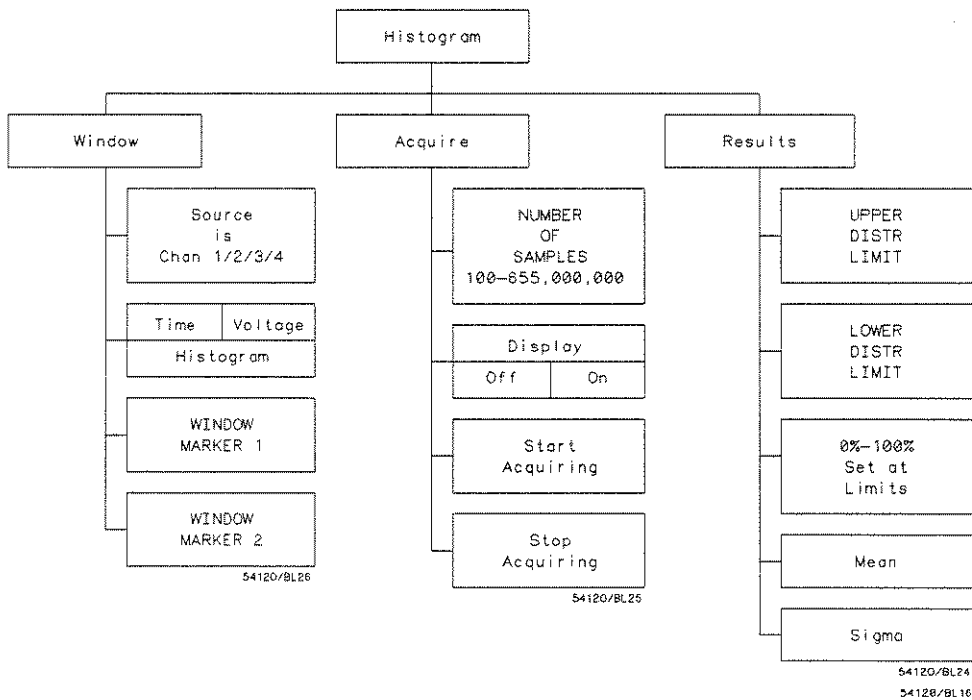

Figure 15-1. Histogram Menu Schematic

Overview

Analog oscilloscopes gave the operator an indication of data distribution by displaying the data density in various shades of gray. Now through the convenience of digitizing technology, the HP 54121T enables you to make quantified measurements on this very important signal characteristic.

Histograms and waveform statistics are an extension of the infinite persistence mode of display. Not only can you see the total distribution of the acquired data points, you can quantify the data distribution in both voltage and time.

This capability proves to be very useful in applications like evaluating the distribution of an eye diagram, determining min/max data, evaluating jitter and noise, measuring setup and hold times, characterizing pulse variations in pulsed RF, or any other application where the probability of distribution density is important.

The histogram menu uses the bandwidth mode set in the display menu.

The Histogram menu also allows you to automatically determine the two most meaningful qualities of a distribution – mean and standard deviation.

Making a histogram measurement is a three-step process:

- the portion of the waveform to be analyzed is defined in the Window submenu
- the amount of data is determined and the acquisition of the histogram is accomplished in the Acquire submenu
- the histogram is analyzed in the Results submenu

The oscilloscope provides two sets of markers in the Histogram menu.

- one set (window markers) is displayed in the Window submenu
 - they define the portion of the waveform used to generate the histogram
- the other set (distribution limit markers) is displayed in the Results submenu
 - they define the portion of the waveform used to calculate mean and sigma
 - they define the mean and sigma when either of these keys are pressed

Selecting the Histogram menu:

- turns on two window markers
- oscilloscope's bandwidth is selectable by the bandwidth key
- places the oscilloscope in the infinite persistence mode
- allows you to choose the Window submenu which
 - lets you adjust markers that act as boundaries for the histogram data
 - select time or voltage histogram
 - select the source to be evaluated
- allows you to choose the Acquire submenu which
 - lets you control the acquisition and display of the histogram
- allows you to choose the Results submenu which
 - lets you evaluate the distribution of the data points in the histogram and determine mean and sigma (standard deviation)

Note

The setup of the Histogram menu will be remembered when you return to the menu. This feature allows you to leave the menu, go to another one, and return without losing your original setup and window marker positions.

Additional information on the use of Histograms can be found in Product Note 54120-1 "Histograms and Statistical Analysis of Signals for use with HP 54120T Digitizing Oscilloscope" HP Part Number 5954-2693.

Window Submenu

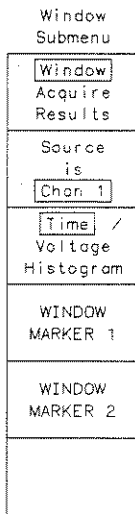

54120E30

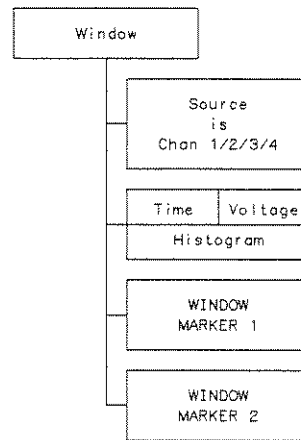

54120/BL26

Figure 15-2. Window Submenu Schematic

The Window submenu allows you to:

- determine which channel is to be used for generating the histogram
- choose either a time or voltage histogram
- move markers to define what portion of the waveform is to be used for generating the histogram

**Source Is Chan
1/2/3/4 Key**

Pressing the Source Is Chan 1/2/3/4 key allows you to:

- select channel 1 through 4 as the source for the histogram
 - as a new source is selected, the previous source is turned off

Note

Channels 1 through 4 are the only sources for histograms; waveform math functions and memories are excluded as sources.

**Time/Voltage
Histogram Key**

Pressing the Time/Voltage Histogram key:

- determines whether a time or voltage histogram is to be generated
 - assigns vertical window markers for voltage histograms
 - assigns horizontal window markers for time histograms

**Window Marker 1
and 2 Keys**

Pressing the WINDOW MARKER 1 or 2 key:

- allows you to control the position of the selected marker used to
 - define the portion of the waveform for generating the histogram

Acquire Submenu

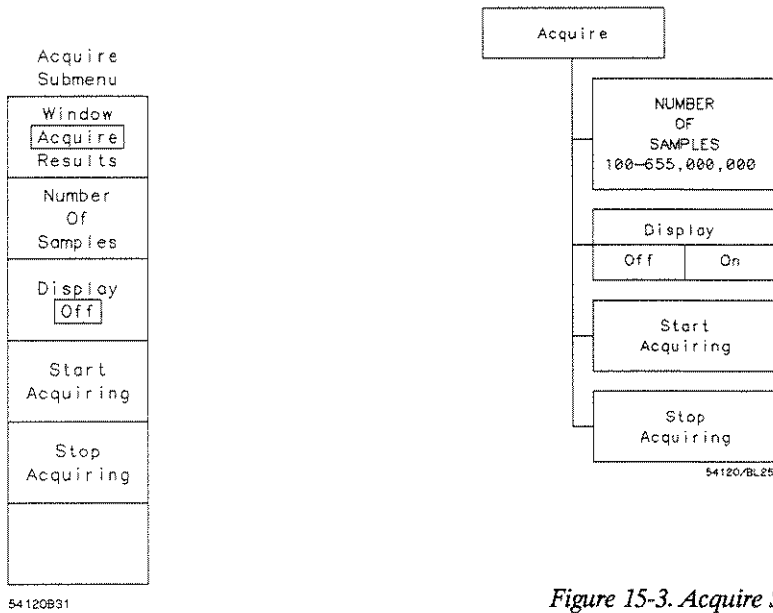

Figure 15-3. Acquire Submenu

After the source and type of histogram have been selected with the Window submenu, the Acquire submenu is used to define the number of data samples for completing the histogram. The number of samples refers to the number of data points inside the window markers. The Acquire submenu also lets you control the acquisition and display of the histogram.

Number of Samples Key

Adjusting the NUMBER OF SAMPLES:

- determines the number of samples that must be acquired in the histogram window before the acquisition is considered complete
- the NUMBER OF SAMPLES ranges from
 - 100 to
 - 655,000,000 (only accessible by using the knob)

The NUMBER OF SAMPLES selected for a histogram is typically influenced by the application. For applications like jitter measurements and eye diagram evaluations, a larger NUMBER OF SAMPLES is used to improve resolution, but for applications like limit testing, a smaller value can be used. See chapter 3 for more information.

Another variable that must be considered before you choose the NUMBER OF SAMPLES when you are making a time histogram is the width of the window. If you choose a narrow window and use a large number of samples, the acquisition can take a very long time. The narrower the window, the smaller the percentage of acquired data points for satisfying the required NUMBER OF SAMPLES. Window width does not affect the time required for a voltage histogram as much as it does for a time histogram.

A histogram that has an inadequate NUMBER OF SAMPLES usually has a stair step appearance unlike a histogram with an adequate number of samples which appears to be a continuous function.

Display On/Off Key

Pressing the Display On/Off key:

- turns the histogram display on or off
 - if this key is pressed and no histogram data has been acquired, the prompt "No valid data...key ignored" is displayed
 - this key changes from off to on when a histogram acquisition is completed

Start Acquiring Key

Pressing the Start Acquiring key:

- causes the data for a histogram to be acquired and
- displays the histogram
- the histogram will overlap the signal
- previously acquired histogram data is lost

Note

With voltage histograms the NUMBER OF SAMPLES is rounded to the next multiple of the number of time buckets defined by the window markers. This prevents an incomplete data acquisition from biasing the data. The Number of Samples prompt at the top of the display will list the rounded value.

While you are in the Histogram menu a status line at the upper left of the CRT tells you what percentage of the NUMBER OF SAMPLES has been acquired.

Stop Acquiring Key

Pressing the Stop Acquiring key:

- stops the acquisition of data for a histogram and
- displays the data acquired up to that time

Note

The histogram data is modified by a 3-pixel wide median filter before being displayed.

Results Submenu

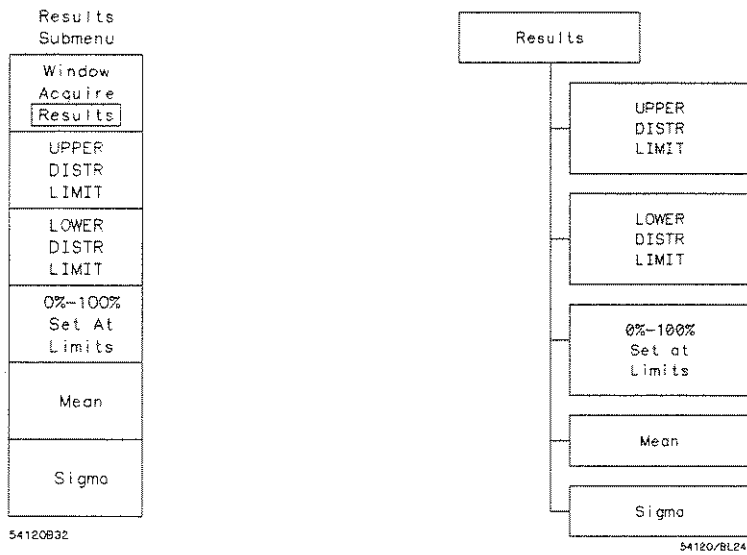

Figure 15-4. Results submenu

After you have used the Window and Acquire submenus to identify the area of interest and have acquired the data for a histogram, you are ready to use the Results submenu to evaluate that data.

**Upper and Lower
Distr (Distribution)
Limit Keys**

Selecting the UPPER or LOWER DISTR LIMIT keys:

- allows you to position the limit markers with the entry devices
 - provides voltage or time information associated with the limit markers in the waveform factors area
 - provides a cumulative percentage of data below or to the left of each limit marker

Note

When you evaluate a voltage histogram, the limit markers provide information associated with voltage levels, and the percentage information relates to data below the specified limit marker. When you evaluate a time histogram, the limit markers provide information associated with time, and the percentage information relates to data to the left of the specified limit marker.

**0%-100% Set At
Limits Key**

Pressing the 0%-100% Set At Limits key:

- causes the oscilloscope to read the position of the upper and lower distribution markers
 - the portion of the histogram defined by the limit markers is used as the data base for determining mean, sigma, and waveform factors associated with the limit markers
 - if the distribution markers are moved, the 0%-100% Set At Limits key must be pressed so that the new positions are read; if the 0%-100% Set At Limits key is not pressed, the portion of the waveform that was previously defined by the limit markers will continue to be used as the data base
- highlights the portion of the histogram defined by the limit markers in blue
- the highlighted (blue) portion of the histogram is used as a data base for:
 - mean
 - sigma
 - lower/upper limit prompt at the top of CRT
 - limit marker factors listed at the bottom of the CRT

See note on next page.

Note

If a histogram is acquired and no data is found between the limit markers, the limit markers will be set to the limits of the waveform display area (0% and 100%). This data will be used to calculate the mean.

Mean Key

Pressing the Mean key:

- causes the oscilloscope to calculate the statistical mean of the data base and to list the results at the bottom of the display
 - the data base is defined as the data between the distribution limit markers when the 0%-100% Set At Limits key was last pressed.
- both markers are positioned at the mean.

$$\bar{X} = \frac{1}{N} \sum_{i=1}^N X_i$$

54120M01

Sigma Key

Pressing the Sigma key:

- causes the oscilloscope to calculate the standard deviation of the data base and to list the results at the bottom of the display
 - the data base is defined as the data between the distribution limit markers when the 0%-100% Set At Limits key was last pressed.
 - positions markers at \pm one standard deviation
- calculate the mean and display the results

$$\text{Sigma} = \sqrt{\frac{1}{N-1} \left(\sum_{i=1}^N (X_i - \bar{X})^2 \right)}$$

54120M02

Note

These measurements use data as defined by the Set at Limits key.

Histogram Exercise

This exercise shows you how to evaluate both time and voltage data distributions with histograms. After the data for a histogram has been acquired, you will be able to determine the mean and standard deviation of the data by using the automatic statistical capabilities of the oscilloscope. This exercise also gives you the opportunity to evaluate signal jitter and to make measurements on a waveform with a multimodal distribution.

Notice, as you are working your way through this exercise, a time window is used to define the portion of the waveform that is used as a data base for a voltage histogram, and the converse is true – i.e., a voltage window is used to generate a time histogram.

Equipment required:

- HP 54121T oscilloscope

Initial Setup for HP 54121T

To turn on the internal pulse generator:

- select the **Network** menu and the **Cal** submenu
- set the **Reflect Chan Is** key variable to **Chan 1**
- press the **Preset Reflect Channel** key (this turns the TDR pulse on and scales the vertical and horizontal)

To rescale the horizontal:

- select the **Timebase** menu and set **TIME/DIV** = 10 ps/div

To display the edge of interest:

- adjust **DELAY** until the incident pulse is at center screen by rotating the knob slowly ccw. The waveform should resemble figure 15-5 on the next page.

To make a histogram measurement:

- select the **Histogram** menu
- select the **Window** submenu and **Voltage Histogram**, move one window marker to the left of the display and move the other to the right
- select the **Acquire** submenu, set **NUMBER OF SAMPLES** = 10000 and press the **Start Acquiring** key

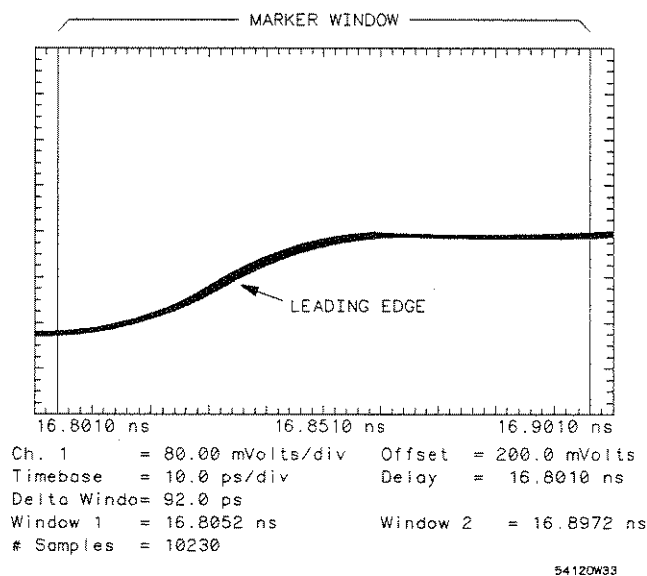

Figure 15-5. Leading Edge

When you press the Start Acquiring key, approximately 10,000 data points are acquired between window markers. When the acquisition is complete, or when the Stop Acquiring key is pressed, the oscilloscope displays a histogram of the voltage levels distribution of the data points. This particular histogram is bimodal – i.e., it has two significant peaks on the distribution.

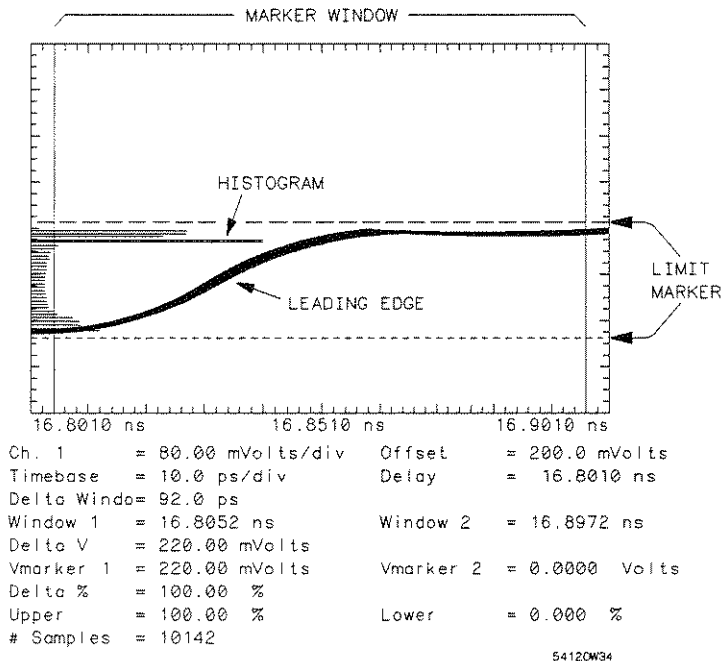

Figure 15-6. Voltage Histogram

- select the Results submenu, move the distribution limit markers to the upper and lower limits of the histogram, and press the **0%-100% Set At Limits** key

This defines the portion of the histogram enclosed by the limit markers as the data base for calculating the mean and sigma.

- press the **Mean** key
- press the **Sigma** key

Notice both limit markers move to the mean of the distribution when the Mean key is pressed, then they define \pm one standard deviation from the mean when the Sigma key is pressed.

- move the distribution limit markers to the top of the waveform so they include the first peak on the histogram. See figure 15-7.

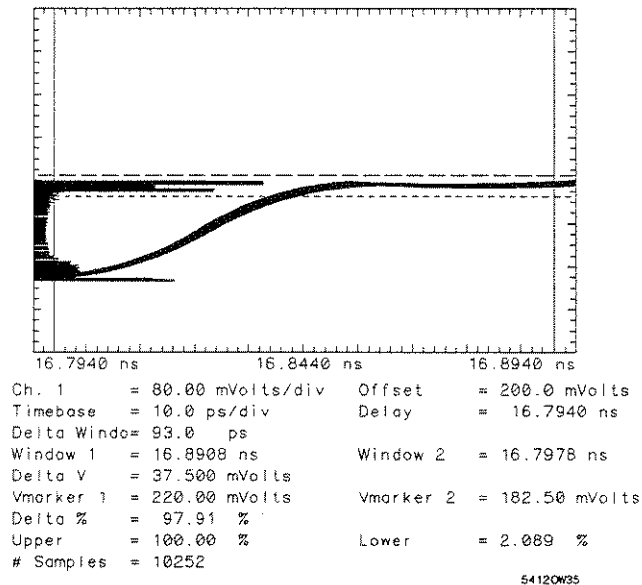

Figure 15-7. Evaluating the Distribution on a Multimodal Signal

- after you press the 0%-100% Set At Limits key, you can calculate the mean and sigma values for new positions of the limit markers

This histogram shows you the voltage distribution for the pulse top. The technique used in this portion of the exercise can be used to evaluate voltage jitter on a signal.

Note

When you press the 0%-100% Set At Limits key with the limit markers at their new positions, the portion of the histogram that is used to calculate the mean and distribution is highlighted in blue. This makes it very easy to identify what portion of the histogram is the current data base for the limit markers, sigma, and mean.

To display the histogram without displaying the waveform:

- press the **STOP** system key
- then press the **CLEAR DISPLAY** system key

To display the data inside the window markers:

- press the **STOP** system key
- then press the **CLEAR DISPLAY** system key
- select the Acquire submenu
 - press the Start Acquiring key

This simplifies the display by showing only the portion of the waveform that is used to generate the histogram. See figure 15-8.

Note

This technique can be used only on voltage histograms.

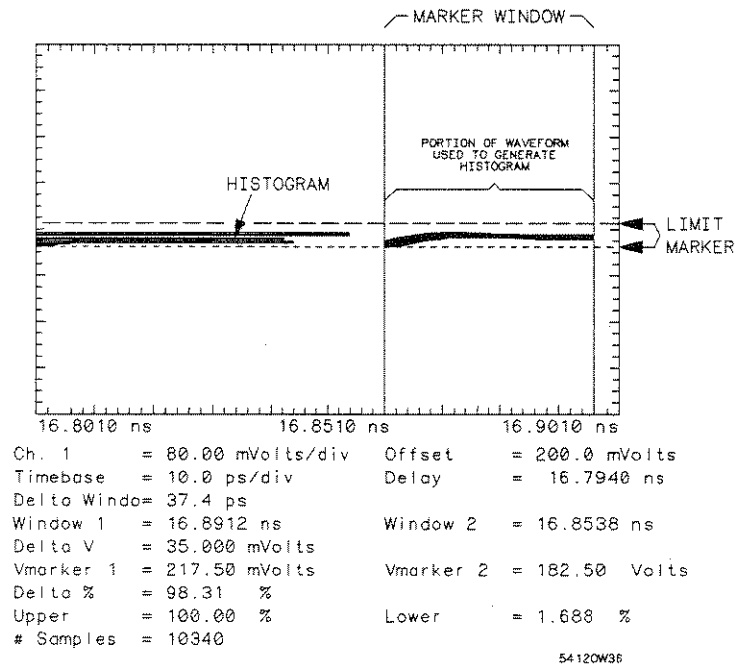

Figure 15-8. Using the Window Markers

Time Histogram

To continue with the time histogram portion of this exercise use the same setup as the voltage histogram except:

- On the Window submenu:
 - change from **Voltage** to **Time Histogram**
 - set **WINDOW MARKER 1** and **2** so they intersect the leading edge of the TDR pulse at the same point. See figure 15-9.
- On the Acquire submenu:
 - set **NUMBER OF SAMPLES** = 300
 - press the **Start Acquiring** key

Note

You will notice that a narrow window (one Q level wide) used with a time histogram takes much longer to acquire than does a voltage histogram, even though the voltage histogram has a larger NUMBER OF SAMPLES – i.e., 10000 vs 300.

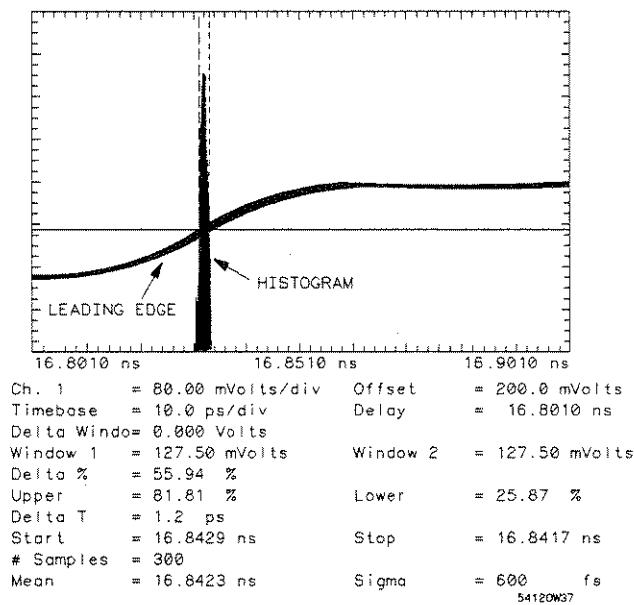

Figure 15.9. Time Histogram

Putting the limit markers at the same location gives you the highest possible resolution for making a time jitter histogram. When the limit markers are at the same level the voltage window is approximately zero. This allows you to measure the jitter at a single voltage. The HP 54121T used for designing this exercise has 600 fs (0.6 ps) jitter (one standard deviation).



Chapter Contents

- how to make a copy of the screen with an HP-IB graphics printer

Overview

The Print menu allows you to make a copy of the display area with an HP-IB graphics printer.

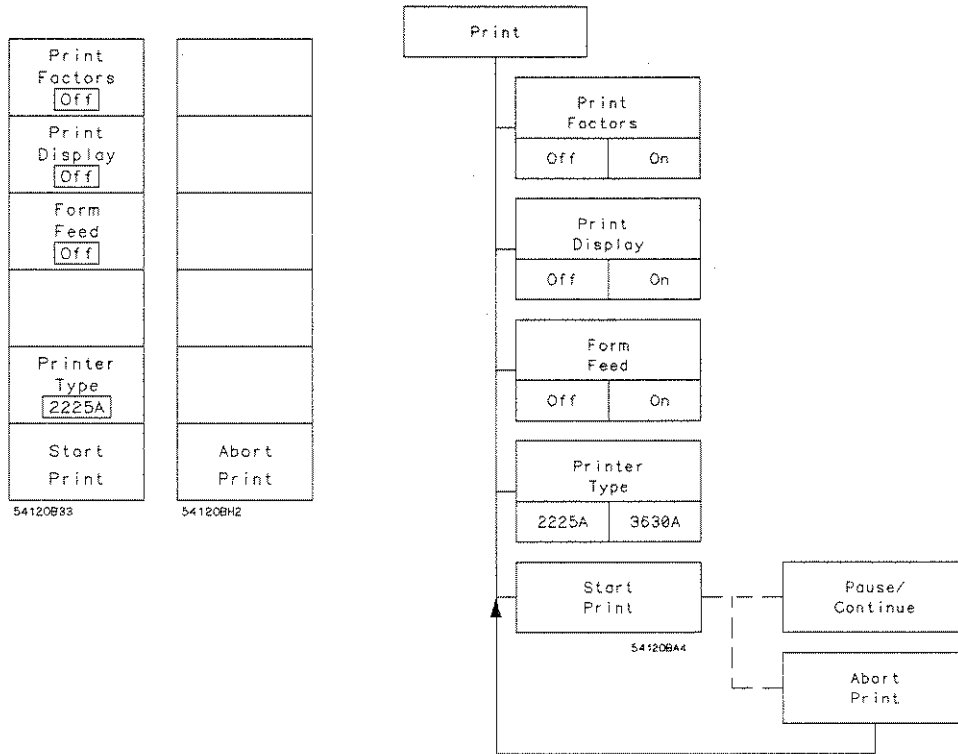

Figure 16-1. Print Menu

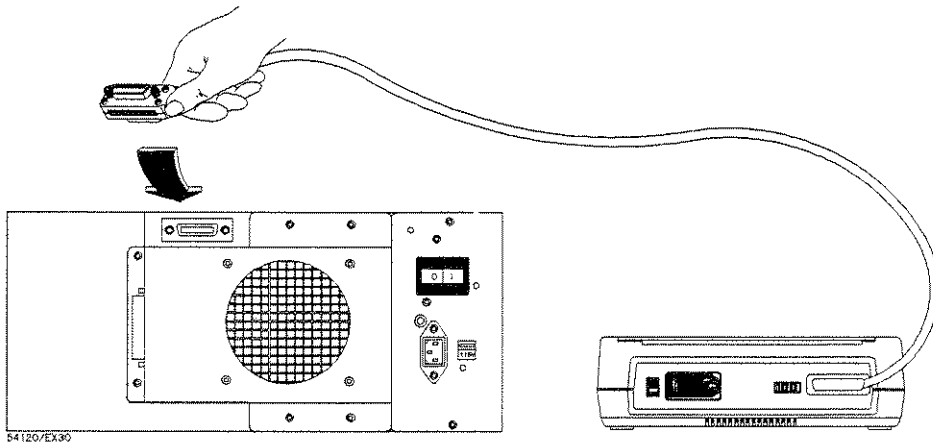

Figure 16-2. Connecting a ThinkJet® Printer

Setting Up for Printing

To make a hardcopy without a controller, the HP 54121T must be in the "Talk Only" mode (the HP 54120B is shipped from the factory in the "Talk/Listen" mode) and the printer must be in the "Listen Only" or "Listen Always" mode. The HP-IB status for the HP 54121T is set in the HP-IB menu, which is a submenu of the Utility menu. See Chapter 18.

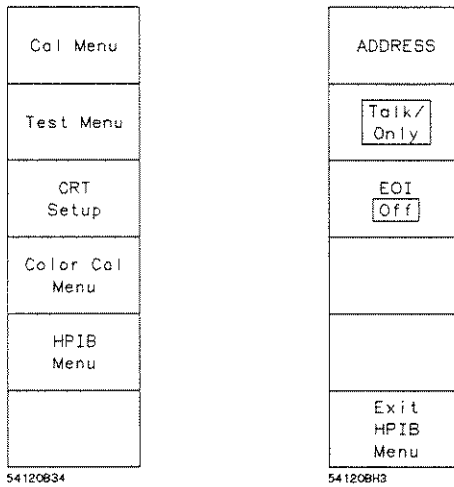

Figure 16-3. Utility and HP-IB Menus

If the printer or plotter doesn't have a DIP switch on the rear panel labeled "Listen always," set all the switches to "1." This will usually set the printer or plotter to the "Listen always" mode.

Print Menu Options

Print Factors Off
Print Display Off
Form Feed Off
Printer Type 2225A
Start Print

54120835

The Print menu:

- lists print options for data that is output over the HP-IB to a printer compatible with the HP Printer Command Language (PCL)

The Print menu allows you to modify the output with two print options:

- automatic Form Feed
- Printer Type
 - 2225A (ThinkJet) for monochrome graphics printer
 - 3630A (PaintJet) for color graphics printer
 - The color for channel 1, overlap and background are variable for the 3630A. See chapter 18, "Color Cal Menu" for information; all other colors are the same as screen colors.

The factors and the display, including the graticule, may be output separately or together.

When you start the printing process:

- the Abort Print key replaces the original menu
- signal acquisition stops temporarily while the printer is operating

Tip

The HP 3630A PaintJet can be set to listen always by setting switches as follows: A1, A2, and A3 = 1; SCS/NORM = NORM

Chapter Contents

- how to make a copy of the screen with an HP-IB plotter

Overview

The Plot menu allows you to make a copy of the display area with an HP-IB plotter.

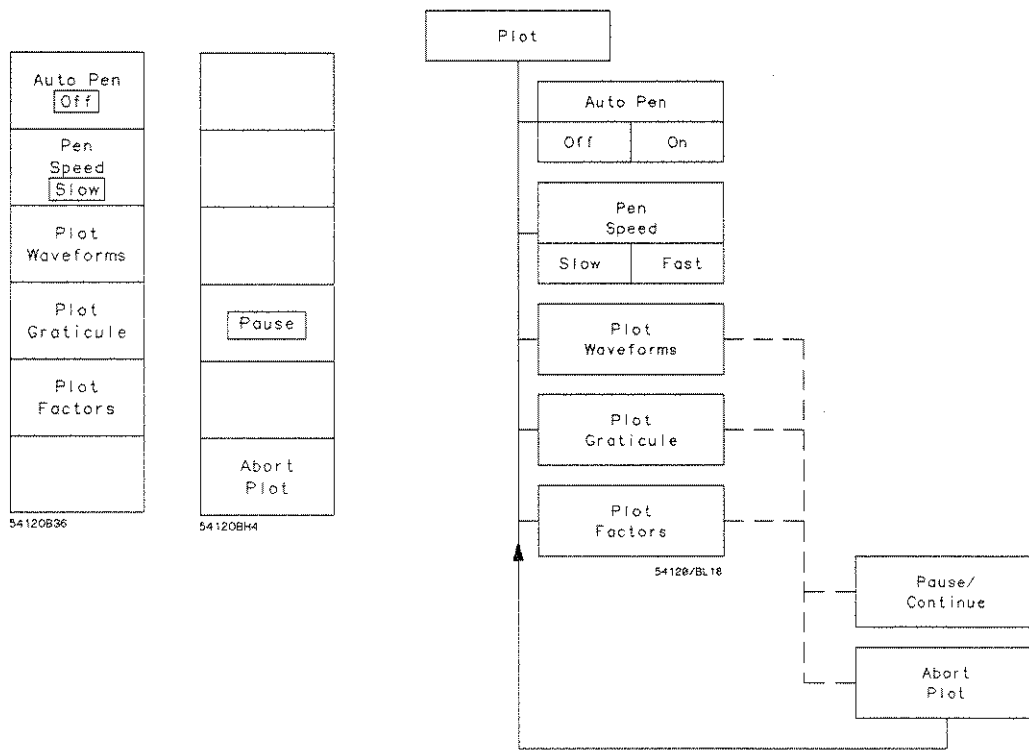
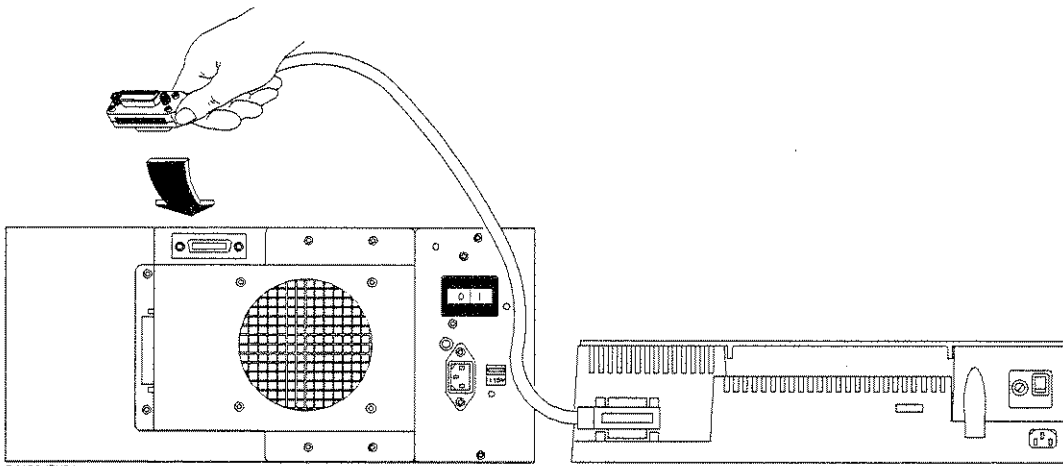

Figure 17-1. Plot Menu



54120/EX31

Figure 17-2. Connecting a Plotter

Setting Up for Plotting

To make a plot without a controller, the HP 54121T must be in the "Talk Only" mode (the HP 54120B is shipped from the factory in the "Talk/Listen" mode) and the plotter must be in the "listen only" mode. The HP-IB status for the HP 54121T is set in the HP-IB menu, which is a submenu of the Utility menu. See Chapter 18.

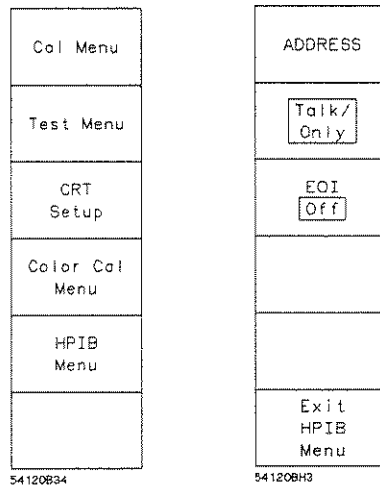

Figure 17-3. Utility Menu and HP-IB Submenu

If the printer or plotter doesn't have a DIP switch on the rear panel labeled "Listen Always," set all the switches to "1." This will usually set the printer or plotter to the "Listen Always" mode.

Plot Menu Options

If you select a Plot menu:

- the output of the HP 54121T is formatted to interface directly with plotters that use the Hewlett-Packard Graphics Language (HP-GL) and an HP-IB interface

The Plot menu allows you to plot one of the following:

- display (waveforms)
 - graticule
 - factors
-

Auto Pen Key

If the Auto Pen key is on and the plotter has multi-pen capability:

- the plotter selects a new pen when a different item is plotted the default pen selections are:
 - pen 1 = timebase setting, graticule, channel 3 and associated text
 - pen 2 = channel 1, function 1 and associated text
 - pen 3 = memories and associated text
 - pen 4 = channel 2, function 2 and associated text
 - pen 5 = markers, cursor and associated text
 - pen 6 = channel 4 and associated text
- If the Auto Pen key is off:
 - the plotter does not load or change pens when a new item is selected

Pen Speed Key

The Pen Speed key allows you to select fast/slow speeds. If the plotter has this capability:

- select slow when you are making overhead transparencies and using drafting pens

If the Display menu is in the persistence mode or if you are plotting pixel memories:

- the output from the HP 54121T causes the plotter to plot the display in a pixel format (dot by dot)
- this can take a long time

Tip

When a large amount of data is on screen in the persistence display mode, and you want to make a hardcopy, a graphics printer will take much less time.

When the Display menu is in the averaged mode or plotting waveform memories:

- the output from the HP 54121T causes the plotter to plot the display with a continuous line

When you start the plotting process:

- the original menu is eliminated
- the Pause/Continue and the Abort Plot keys are substituted for the Plot menu
- and signal acquisition stops

Chapter Contents

- description of the Utility menu
- how to use the self-calibration feature
- how to adjust channel-to-channel timing
- how to control the display colors
- how to control the HP-IB interface

Cal Menu
Test Menu
CRT Setup
Color Cal Menu
HP-IB Menu

54120B37

Overview

Pressing the Utility menu key allows you to access five more menus that are displayed in the function menu area. These menus are:

- Cal Menu
 - sets vertical calibration
 - sets channel-to-channel timing
- Test Menu
 - allows analysis of self-test failures
 - shows internal configuration of the oscilloscope
- CRT Menu
 - allows testing of the CRT
- Color Cal Menu
 - allows adjustment of CRT colors
- HP-IB Menu
 - allows configuration changes in the HP-IB interface

The Test menu and the CRT Setup menu are discussed in the *HP 54120B Service Manual* and are not covered here.

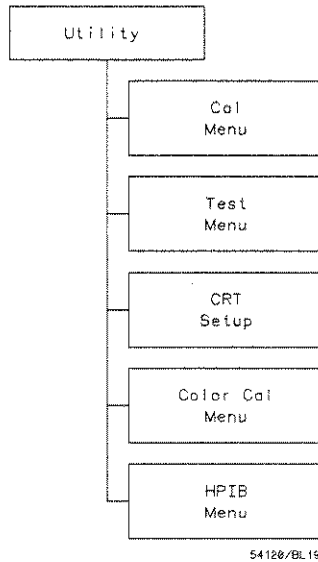

Figure 18-1. Utility Menu Schematic

Cal Menu

Channel Vertical Cal
Channel Skew Cal
Exit Cal Menu

54120B36

Selecting the Cal Menu:

- allows you to automatically calibrate the vertical accuracy
- allows you to null the time differences between the acquisition paths of channels 1 through 4
 - this includes acquisition time differences, both internal and external to the instrument

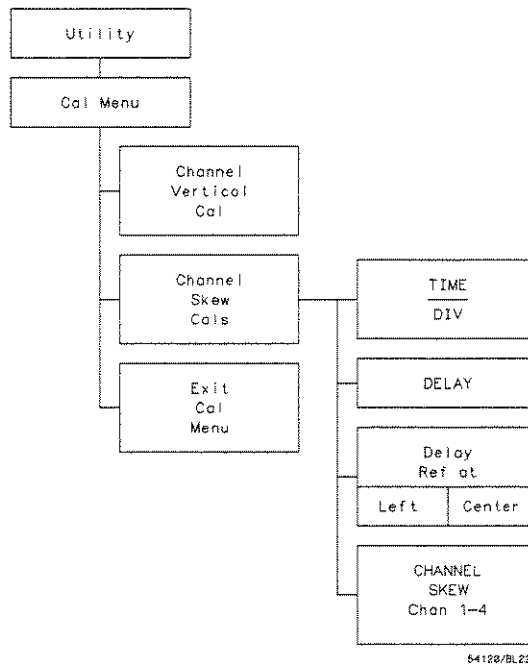

54120/BL22

Figure 18-2. Cal Menu Schematic

Channel Vertical Cal Key

The Channel Vertical Cal key allows you to automatically calibrate the vertical accuracy of the HP 54121T. When this automatic calibration is completed as specified in chapter 19 of this manual, the instrument conforms to the vertical accuracy specification.

Note

The specified vertical accuracy of the HP 54121T is 0.4% of full scale. This assumes that the HP 54120B and the HP 54121A are kept together as shipped from the factory. If another test set is combined with the HP 54120B, the offset gain adjustment for each channel must be readjusted and the Channel Vertical CAL must be performed. See section 4 of the service manual for the Test Set.

For best results ensure that the instrument is at normal operating temperatures before you complete any of the Cal menu operations. Typically 15 minutes is an adequate warm-up in a laboratory environment.

To calibrate the vertical accuracy:

- press the Channel Vertical Cal key
 - a prompt will appear telling you to "Disconnect all inputs and then press key again"
- disconnect all inputs to the HP 54121A, including the trigger input
 - zero level is the reference for the automatic calibration
 - input shorts will not influence the self-calibration and may be left in place
- press the Channel Vertical Cal key a second time
 - this initiates the self-calibration sequence
- the status line will flash "Calibrating" during the calibration cycle (typical time = 5 seconds)

While the automatic vertical calibration takes place, gain correction tables are created for high and low bandwidth modes. These tables contribute to the exceptional accuracy of the HP 54121T.

Channel Skew Cal Key

The channel skew cal function allows you to null any acquisition time differences between a channel and its acquisition path and the other channels and their acquisition paths.

The objective of the cal procedure is to apply a fast risetime signal to the oscilloscope and null the systematic delays between the channels.

With HP 54121T software the Channel Skew Cals submenu allows you to null any differences in propagation delay between signal paths. This enables you to make channel-to-channel time interval measurements that accurately reflect time referenced to the probe tips or to the points where the input coaxial cables are connected to the circuit under test.

To set the channel-to-channel skew, you must:

- use the same external configuration of probes and/or cables that will be used for the actual measurement
- use fast edges for the trigger and channels

Note

For the most accurate channel-to-channel skew adjustment, use the fastest signal possible. To calibrate skew between channels to within 1 ps accuracy, make sure the edge of the signal is fast enough for you to see it at a TIME/DIV setting of 50 ps/div. This setting provides 1 ps/pixel resolution. A 500 ps risetime pulse provides a 45 degree edge at this TIME/DIV setting.

Selecting the Channel Skew Cal key provides the following functions:

- TIME/DIV
 - allows you to adjust the TIME/DIV that is used when you are in the Channel Skew Cals submenu
 - the oscilloscope returns to the TIME/DIV setting established in the Timebase menu when you leave the Channel Skew Cals submenu

- DELAY
 - allows you to adjust the horizontal position of the waveform when you are in the Channel Skew Cals submenu
 - the oscilloscope returns to the DELAY setting established in the Timebase menu when you exit the Cal menu
- Delay Ref at Left/Center
 - allows you to select either the center or left of the display as the reference for the delay time
 - as the TIME/DIV is varied the waveform either contracts or expands about the delay reference
 - reference defaults to left when Channel Skew Cals submenu is entered
- Channel Skew
 - when the CHANNEL SKEW key is first selected, the timing skew of the indicated channel can be adjusted from 0 s to 100 ns with the entry devices
 - a channel must be turned on to be used as a source for the channel skew adjustment
 - if the CHANNEL SKEW key is pressed more than once, the selected channel is changed. Only the channels that were turned on when you selected the Channel Skew Cals submenu can be selected.

This sequence shows you the basic steps required to set channel-to-channel skew. The right column provides additional information for each step.

- | | |
|---|--|
| 1. Configure probes and/or cables for the measurement | Make sure that you use the same cable and probe configuration that will be used for the actual measurement. |
| 2. Turn on necessary channels. | Turn on the channels that will be used for the actual measurement so they can be adjusted with the CHANNEL SKEW key. |
| 3. Set VOLTS/DIV to the appropriate levels. | Set the vertical sensitivity for each channel so that the deflection is near full scale. |

- | | |
|--|---|
| 4. Set TRIGGER LEVEL to an appropriate level. | The faster the trigger edge, the less chance there is for trigger jitter. |
| 5. Connect the channels and trigger input to the appropriate sources. | For the most accuracy, the sources for the channels should have the fastest edges possible. |
| 6. Select the Utility Menu. | Provides access to the Cal Menu. |
| 7. Select the Cal Menu. | Provides access to the Channel Skew Cals submenu. |
| 8. Select the Channel Skew Cals menu. | Provides access to the functions required to set channel skew. |
| 9. Adjust TIME/DIV, DELAY, and Delay Ref for optimum display. | For best resolution adjust the leading edge for a 45 degree slope. An intersection with a graticule line may be used as a reference point.

Use the first available edge on each channel to set the skew. This minimizes time jitter. |
| 10. Select the reference edge. | Each channel can be skewed to the left; therefore, the reference edge should be to the left of the comparable edges on the other channels. |
| 11. Press the CHANNEL SKEW key and select a channel with the associated edge skewed to the right of the reference edge. See figure 18-3. | This selects the channel that is skewed when the entry devices are adjusted. |

12. Use the entry devices and adjust the skew until the signal from the channel overlaps the reference edge. See figure 18-4.

This nulls the systematic time differentials between the channels.

13. Repeat steps 11 and 12 for each additional channel used.

Steps 11 and 12 must be repeated if more than two channels are to be used in the actual measurement.

When you exit the Cal menu, the TIME/DIV, DELAY, and Delay Reference are returned to their original values. The skew values are maintained until they are changed or until a two-key-down power-up is accomplished. In this case a display prompt will flash "Front panel cals lost! Re-cal thru Utility menu." All the channel skew values will be set to zero, and the prompt will remain on the display until a channel vertical cal is completed.

Figure 18-3 shows the reference edge and a signal on another channel before the channel is skewed to eliminate the time differential.

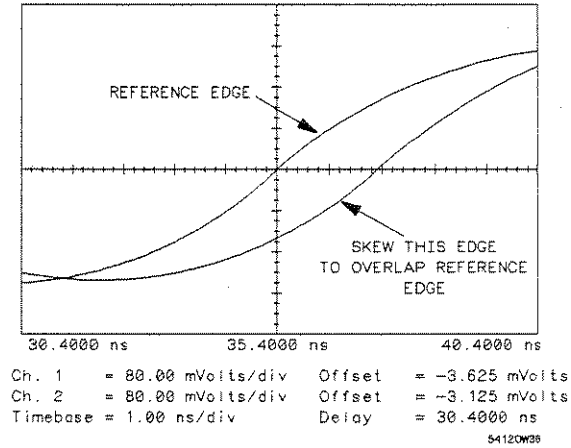

Figure 18-3. Reference Edge and Channel with Time Differential

Figure 18-4 shows the reference edge and the channel overlapped after the skew for the channel was adjusted.

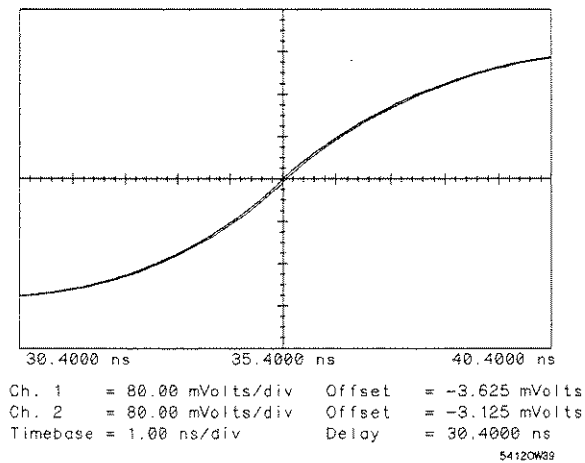
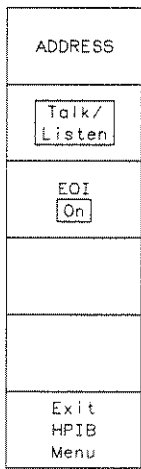

Figure 18-4. Reference Edge and Channel Overlapped

HP-IB Menu

Select the HP-IB menu when you need to connect the HP 54121T to other HP-IB devices. This menu allows you to establish the HP 54121T as an HP-IB talker or talker/listener.



54120B39

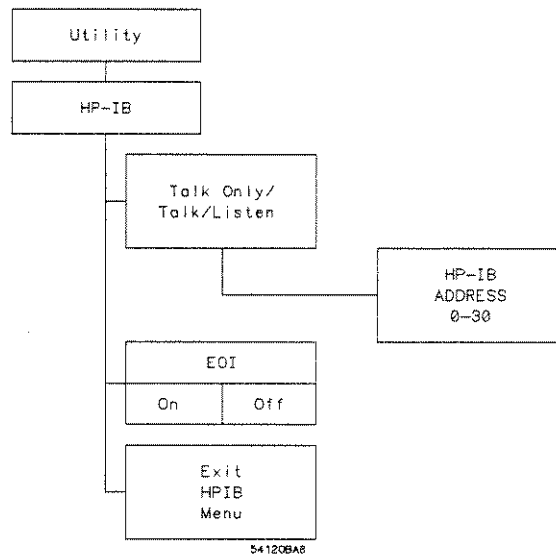

54120BA8

Figure 18-5. HP-IB Menu Schematic

After you have selected the HP-IB menu, you may set the HP-IB mode to:

- Talk
 - use the Talk Only mode when communicating with an HP-IB printer or plotter if no other HP-IB device is connected to the system
- Talk/Listen
 - when Talk/Listen is selected, the HP-IB ADDRESS key is activated, and the default address is 7
 - HP-IB address can be set with the entry devices

EOI Key

The EOI (end or identify) key allows you to invoke this HP-IB function. When EOI is "On" the HP 54121T will identify the last byte of a multibyte sequence that it outputs over the HP-IB. The default condition for EOI is "On."

Refer to the programming manual for a complete discussion of the HP 54121T's HP-IB capabilities.

Color Menu

The Color Cal menu allows you to modify the HP 54121T display by changing any of the assigned colors or resetting them to the default condition.

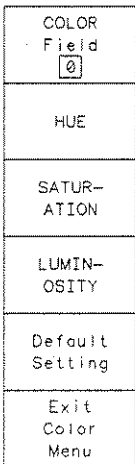

54120840

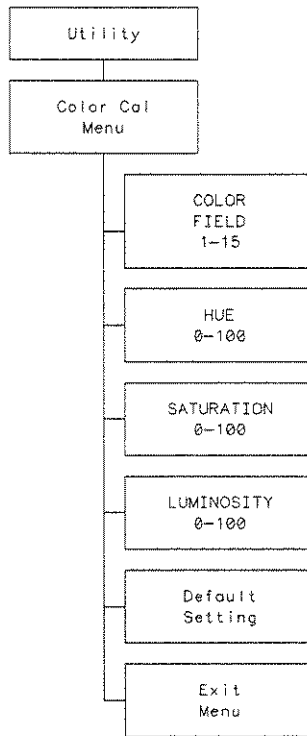

541208A7

Figure 18-6. Color Menu Schematic

Color Field Key

The color field key allows you to:

- select the color field that is acted upon by the rest of the Color Cal menu.
- Pressing the key repeatedly cycles the color field number from 0 to 15.

You can modify all 16 colors individually to suit a specific need or personal preference. Once you have made a selection, it will be maintained in non-volatile memory. Color setup is also saved in the front-panel SAVE and RECALL registers. If a two-key-down power-up is performed, setups in the SAVE and RECALL registers will be lost and all colors will be set to their default values.

Hue Key

The HUE key allows you to:

- change the gradation of color
 - the gradation ranges from 0 to 100, with red located at 0/100, green at 33, and blue at 67
 - use any of the entry devices

Saturation Key

The SATURATION key allows you to:

- define the percentage of color to be mixed with white
 - this function ranges from 0 to 100, with 0 as white regardless of the hue setting, and 100 the pure color determined by hue
 - use any of the entry devices

Luminosity Key

The LUMINOSITY key allows you to:

- define the relative brightness of the color, with 0 as black and 100 the maximum brightness
 - use any of the entry devices

Default Setting Key

The Default Setting key allows you to:

- set all colors to their default states

Table 18-1. Default Color Settings

COLOR #	COLOR	USE	HUE	SATURATION	LUMINOSITY
0	Beige	Highlighting	11	53	100
1	Gray	Halfbright	0	0	55
2	Red	Advisory	0	100	100
3	Yellow	Channel 1	17	100	100
4	Green	Channel 2	33	100	100
5	Orange	Markers	8	100	100
6	Blue	memories & histogram	50	85	90
7	Magenta	trace overlap	90	100	100
8	Tangerine	Channel 3	11	100	100
9	Pink	Channel 4	3	60	100
10	Purple	Chan1 for HP 3630A	84	91	54
11	White	Background for HP 3630A	0	0	100
12	Black	Overlap for HP 3630A	0	0	0
13	Blue	not used HP-IB Text	67	75	100
14	Mauve	not used HP-IB Text	83	100	100
15	Black	Background HP-IB Text	0	0	0

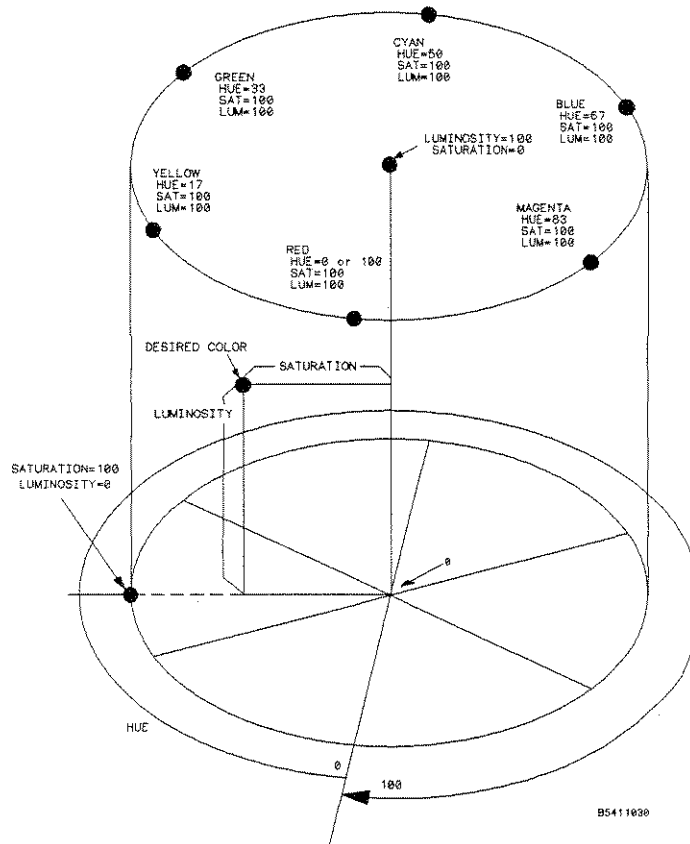

Figure 18-8. HSL Color Model

This figure shows the HSL model with hue as the angular coordinate, saturation the height coordinate, and luminosity the radial coordinate.



Specifications and Operating Characteristics

19

Chapter Contents

- specifications of the HP 54121T
- operating characteristics

Specifications

Channels (Vertical)¹

	20 GHz Bandwidth Mode ²	12.4 GHz Bandwidth Mode
Bandwidth (-3 dB)	dc to 20 GHz, Channels 2, 3, & 4 (Channel 1 is -3.5 dB @ 20 GHz) dc to 18 GHz, Channel 1	dc to 12.4 GHz
Transition Time (10% to 90%) (calculated from $T_r = 0.35/BW$)	≤ 17.5 ps, Chs 2, 3, & 4 ≤ 19.4 ps, Ch 1	≤ 28.2 ps
Maximum Noise (RMS)	≤ 2 mV	≤ 1 mV
Scale Factor (full-scale is 8 divisions)		
Minimum	1 mV/div	1 mV/div
Maximum	80mV/div	80mV/div
dc Accuracy Single Voltage Marker ³		
Average mode:	$\pm 0.4\%$ of full-scale or marker reading (whichever is greater) ± 2 mV	$\pm 0.4\%$ of full-scale or marker reading (whichever is greater) ± 2 mV
Persistence mode:	$\pm 0.4\%$ of full-scale or marker reading (whichever is greater) ± 2 mV $\pm 3.0\%$ of (reading minus channel offset)	$\pm 0.4\%$ of full-scale or marker reading (whichever is greater) ± 2 mV $\pm 1.5\%$ of (reading minus channel offset)

dc Difference Voltage Accuracy Using Two Voltage Markers On The Same Channel³

Average mode	$\pm 0.8\%$ of full-scale or delta marker reading (whichever is greater)	$\pm 0.8\%$ of full-scale or delta marker reading (whichever is greater)
Persistence mode	$\pm 0.8\%$ of full-scale or delta marker reading (whichever is greater) $\pm 3.0\%$ of delta marker reading	$\pm 0.8\%$ of full-scale or delta marker reading (whichever is greater) $\pm 1.5\%$ of delta marker reading

Programmable dc Offset⁴ Channel offset: ± 500 mV

Inputs:

Number	Four
Dynamic Range	± 320 mV relative to channel offset
Maximum Safe Input Voltage	± 2 V dc \pm ac peak (16 dBm)
Nominal Impedance	50 Ω
Percent Reflection	$\leq 5\%$ for 30 ps risetime
Connectors	3.5 mm (m)

1. When operated within $\pm 5^\circ$ C ($\pm 9^\circ$ F) of the temperature of the last front panel calibration.
2. The input samplers are biased differently for increased bandwidth in the 20 GHz bandwidth mode.
3. When driven from a 0 Ω source
4. An effective offset of ± 820 mV can be achieved by using the ± 500 mV of channel offset and adding ± 320 mV of offset with the waveform math offset scaling function.

TDR System

	Combined Oscilloscope and TDR Performance	Normalized Characteristics ¹
Risetime ²	$\leq 45 \text{ ps}^3$	Adjustable-allowable values based on timebase setting Minimum: 10 ps or 0.08 X Time/div, whichever is greater Maximum: 5 X Time/div
Flatness ²	$\leq \pm 1\%$ after 1 ns from edge; $\leq \pm 5\%$, – 2% to 1 ns from edge	$\pm 0.1\%$
Levels: Low High	0 V \pm 2 mV + 200 mV \pm 2 mV	0 V \pm 2 mV + 200 mV \pm 2 mV

¹ Normalized information is a characteristic not a specification. The information is presented here for comparison purposes only. Normalization characteristics are achieved only with the use of the normalization calibrations and firmware routines.

² Measured in the 12.4 GHz Bandwidth and Average Display Modes.

³ The risetime of the generator is less than 35 ps, as calculated by
 $(\text{Tr system})^2 = (\text{Tr generator})^2 + (\text{Tr Scope})^2$

Timebase (Horizontal)

Scale Factor (full-scale is 10 divisions)

Minimum	10 ps/division
Maximum	1 s/division

Delay (time offset relative to trigger)

Minimum	16 ns
Maximum	1000 screen diameters or 10 seconds, whichever is smaller

Time Interval Accuracy

(Dual marker measurement)	$\leq 10 \text{ ps} \pm 0.1\%$ of reading
------------------------------	---

Time Interval Resolution	0.25 ps ¹ or 0.02 division whichever is greater
--------------------------	---

¹ At 10 ps/division, data points are plotted at 0.2 ps intervals to match the display pixel resolution.

Trigger-External Input Only

Sensitivity
(With HF Sensitivity ON)

40 mV peak-to-peak from dc to 100 MHz increasing linearly to 200 mV peak-to-peak at 2.5 GHz.

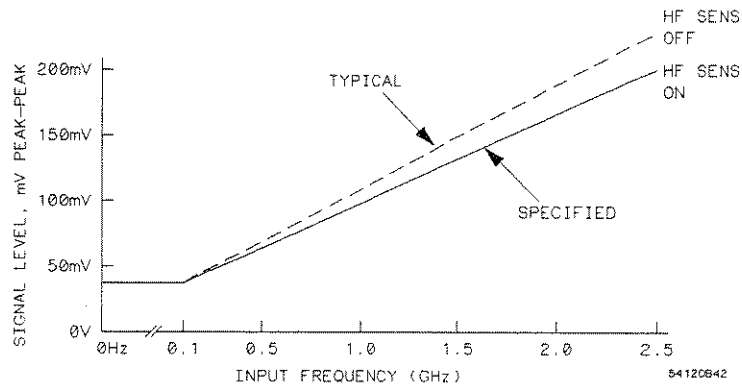

Pulse Width

200 ps for pulses > 200 mV

Trigger Level Range

± 1 V

Jitter

(Trigger and timebase combined) (one standard deviation)

≤ 2.5 ps + $5E-5$ x delay setting tested using a 2 GHz synthesized source at 200 mV peak-to-peak with High Frequency Sensitivity ON and High Frequency Reject OFF

Trigger Input:

Maximum Sensitive

Input Voltage

± 2 V dc + ac peak (16 dBm)

Nominal

Impedance

50 Ω

Percent Reflection

$\leq 10\%$ for 100 ps risetime

Connector

3.5 mm(m)

Operating Characteristics

Channels (Vertical)

Scale Factors : Adjustable from 1 mV/div to 80 mV/div in a 1-2-5-10-20-50-80 sequence from the RPG control or the increment/decrement keys. Also adjustable over the range in 1 mV increments from the numeric keypad.

Attenuation Factors : Factors may be entered to scale the oscilloscope for external attenuators connected to the channel inputs.

Noise: Averaging reduces noise by $1/\sqrt{n}$, where n is the number of averages, until a system limitation of approximately 35 μ V is reached. Typical noise is:

Display Mode	Noise (RMS)
20 GHz bandwidth, Avg = 1	1.2 mV RMS
20 GHz bandwidth, Avg = 256	80 μ V RMS
20 GHz bandwidth, persistence	1 mV RMS
12.4 GHz bandwidth, Avg = 1	500 μ V RMS
12.4 GHz bandwidth, Avg = 256	35 μ V RMS
12.4 GHz bandwidth, persistence	400 μ V RMS

Channel-to-channel Isolation : 60 dB

Timebase (Horizontal)

Delay Between Channels: The difference (up to 100 ns) in delay between channels can be nulled out in 1 ps increments to compensate for differences in input cables or probe length.

Reference Location: The reference point can be located at the left edge or center of the display. The reference point is that point where the time is offset from the trigger by the delay time.

Triggered Mode: Causes the oscilloscope to trigger synchronously to the trigger input signal.

Free Run Mode: Causes the scope to generate its own triggers at a user specified rate (between 15.3 Hz and 500 kHz). Used with the Channel 1 step generator for TDR and transmission measurements. The channel 1 step may also be used to trigger a device under test to view information prior to the trigger.

Typical Accuracy: The timebase consists of a series of 4 ns blocks. Small discontinuities across these blocks is a major contribution to the 10 ps accuracy specification. The graph below is the result of many measurements on 8 instruments.

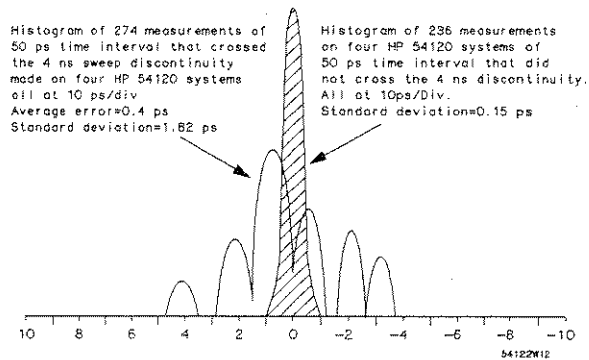

Trigger

Attenuation Factors: Factors may be entered to scale the oscilloscope for external attenuators connected to the trigger input.

Edge Trigger: Triggers on the positive or negative edge of the trigger source.

HF Sensitivity: When on, hysteresis is suppressed for increased sensitivity at high frequencies. When off, hysteresis is added to the trigger comparator to reduce the effect of noise.

High Frequency Reject: Limits Trigger Bandwidth to approximately 100 MHz

Display

Data Display Resolution: 501 points horizontally X 256 points vertically.

Data Display Formats

Full screen: All channel displays are superimposed and are eight divisions high.

Split screen: With four graphs, channels are displayed separately and are two divisions high; or with two graphs, channels 1 and 3 are superimposed and channels 2 and 4 are superimposed and are four divisions high.

Display Modes

Persistence: The time that each data point is retained on the display can be varied from 300 ms to 10 seconds, or it can be displayed infinitely.

Averaging: The number of averages can be specified as powers of 2, up to 2048. On each acquisition, $1/n$ times the new data is added to $(n-1)/n$ of the previous value at each time coordinate. Averaging operates continuously, except over HP-IB where it terminates at the specified number of averages.

Graticules : The user may choose full grid, axes with tic marks frame with tic marks, or no graticule.

Bandwidth: When in the Average or Persistence display modes, the user may select between 20 GHz and 12.4 GHz bandwidth. The 12.4 GHz bandwidth reduces noise. See channel characteristics for bandwidths and noise levels.

Display Colors: Users may choose a default color selection or select their own colors from the front panel, or over HP-IB. Different colors are used for display background, channels, functions, background text, highlighted text, advisories, markers, overlapping waveforms and memories.

Programmability

Instrument settings and operating modes, including automatic measurements, may be remotely programmed via HP-IB (IEEE-488). The HP 54121T can be programmed to take data only at specified time points, or to return only measurement results (i.e., tr, tf frequency, etc.) to speed up data acquisition.

Data Transfer Rate: 115 kbytes/s maximum (data output only)

Typical Measurement Times: 200-700 ms

Data Record Lengths:

Timebase Setting/Histogram Type	# of points/record
10 ps/div < time/div < 20 ps/div	100, or 400
20 ps/div < time/div < 50 ps/div	100, 400, or 800
50 ps/div < time/div < 200 ps/div	100, 500, or 1000
200 ps/div < time/div < 1 s/div	128, 256, 500, 512, or 1024
Voltage Histogram	256
Time Histogram	501

Measurement Aids

Markers: Dual voltage or time markers can be used for a variety of time and voltage measurements. Voltage markers can be assigned to channels, memories, or functions.

Automatic Level Set: Voltage markers may be preset to 10%-90%, 20%-80%, 50%-50%, or to user specified levels.

Automatic Edge Find: The time markers can be assigned automatically to any displayed edge of either polarity on any channel. The voltage markers establish the reference, on the edge for the time markers in this mode.

Automatic Pulse Parameter Measurements: The HP 54121T automatically takes ten pulse parameter measurements, (as defined by IEEE standard 194-1977, "IEEE Standard Pulse Terms and Definitions"). The standard measurement thresholds are 10%, 50% and 90%.

Automatic Pulse Parameter Measurements

Frequency	Risetime
Period	Falltime
Positive pulse width	Preshoot
Negative pulse width	Overshoot
Duty cycle	Vp-p voltage

Waveform Math: Any two of seven waveform math operations may be assigned to two displayable math functions. The available operations are Plus, Minus, Invert, Versus, Max, Min, and Only. Max and Min, which define an envelope about the waveform, are only available in the Persistence mode. The vertical channels or any of the waveform memories, can be used as operands for the waveform math. Function sensitivity and offset may be adjusted independently of the channel display settings.

Waveform Save: Four waveforms may be stored and displayed in four non-volatile waveform memories. Waveform memories are typically used in the Average display mode. Screen displays may be stored in two volatile pixel memories. Pixel memories are typically used in the Persistence display mode.

Networks

Reflection Measurements

Source: Measurements are made using the Channel 1 step source or a user-supplied external source.

Calibration: A reference plane is defined by calibrating the reflection channel with a short placed at the point where the device under test will be connected. The short calibration is followed with a 50 Ω calibration. These calibrations are used to derive the normalization filter.

Cursor : Reads out the percent reflection, impedance, time, and distance from the reference plane to the cursor. (See Note 2.)

Percent Reflection: Automatically calculates the maximum and minimum percent reflection of the waveform shown on screen.

Normalization Filter: Applies a firmware digital filter to the measured data and puts the resulting waveform in memory 1. The risetime of the filter may be varied to allow the user to simulate the edge speeds, which would be seen by the device under actual operation. See TDR output specifications for allowable risetime values. Normalization also removes errors caused by discontinuities prior to the reference plane.

Note 1

Normalization utilizes the Bracewell Transform, which is under license from Stanford University.

Note 2

Percent reflection measurements should be used to quantify reactive peaks and valleys of the TDR display. Impedance measurements are valid only for resistive horizontal flat line TDR displays. Because the accuracy depends on the measurement being made, percent reflection and impedance accuracies are not specified. Percent reflection and impedance measurements are ratios of voltage measurements whose accuracies are specified.

$$\text{Percent Reflection (Rho)} = \frac{(V_{\text{cursor}} - V_{\text{top}})}{(V_{\text{top}} - V_{\text{base}})}$$

$$\text{Impedance (Z)} = 50 \Omega \times \frac{(1 + \text{Rho})}{(1 - \text{Rho})}$$

Where:

Vcursor = voltage at the cursor

Vtop = high level of calibration reflected step

Vbase = low level of calibration reflected step and are determined during the reflection calibration.

Distance measurements are subject to the accuracy of the velocity factor or dielectric constant entered by the user. Since the HP 54121T has no control over the accuracy of these numbers distance accuracy is not specified. Distance is derived from time interval measurements whose accuracies are specified.

$$\text{Distance (d)} = 1/2 \times \frac{\Delta t}{\text{Velocity Constant}}$$

Where Δt = time from the reference plane to the cursor.

$$\text{Dielectric Constant} = (3 \times 10^8 \text{ m/s})^2 (\text{Velocity Constant})^2$$

Where the user enters either a relative Dielectric Constant or a Velocity Constant.

The TDR's ability to resolve the distance between two discontinuities is limited to 1/2 the system risetime. Without normalization, this is approximately 1/2 45 ps or 7 mm in air. For the distance resolution in your media, divide 7 mm by the $\sqrt{\epsilon_{\text{eff}}}$ of your media. With normalization the system risetime can be 10 ps yielding 1.5 mm of resolution in air.

The maximum length the TDR can measure is subject to media loss. For a lossless vacuum, and using a 15.3 Hz TDR repetition rate, the HP 54121T can measure 4900 km. Actual maximum lengths will generally be limited by the losses of the media under test.

Transmission Measurements

Source: Measurements are made using the Channel 1 step source or a user-supplied external source.

Calibration: A calibration with a straight-through path or through a user's standard device determines reference amplitude levels and reference time and distances of the signal path. These reference levels are used for gain and propagation delay measurements.

Cursor: Reads out time referenced to the calibration edge and gain referenced to the transmission calibration results. (See Note 4.)

Propagation Delay and Gain: Automatically calculates the difference in time and distance between the calibration signal path and the test signal path. Also calculates the ratio of the test signal amplitude to the calibration signal amplitude. (See Note 4.)

Normalization Filter: Applies a firmware digital filter to the measured data and puts the resulting waveform in memory 2. The risetime of the filter may be varied to allow the user to simulate the edge speeds, which would be seen by the device under actual operation. See TDR output specifications for allowable risetime values.

Note 3

Normalization utilizes the Bracewell transform, which is under license from Standard University.

Note 4

$\Delta t = \text{Time of the cursor} - \text{Time of reference edge (50\%)}$

$$\text{Gain} = \frac{(V_{top} - V_{base}) \text{ signal}}{(V_{top} - V_{base}) \text{ reference}}$$

$\text{Prop Dly} = \text{Time of test edge (50\%)} - \text{Time of reference edge (50\%)}$

$\text{Distance (d)} = \text{Prop Dly} / \text{Velocity Constant}$

Where $V_{top} = \text{High level of waveform}$

$V_{base} = \text{Low level of waveform}$

Histograms

Time and voltage histograms may be taken with a user-specified number of samples (between 100 and 655,000,000) to be taken within a user-specified voltage window (time histogram) or time window (voltage histogram). To accelerate throughput when taking voltage histograms, samples are taken only in the user-specified time window.

Distribution markers: Two markers, labeled Upper and Lower Distribution Limits, indicate the cumulative occurrences of samples from the edge of the display to a given time (time histogram) or voltage (voltage histogram).

Mean and Standard Deviation: Calculates the mean and standard deviation of a distribution on screen, or between the distribution limits, assuming a Gaussian distribution.

Setup Aids

Auto-Scale: Pressing the AUTOSCALE key automatically adjusts the vertical and horizontal scale factors and the trigger level for a display appropriate to the signals applied to the inputs. The autoscale feature requires a signal with a duty cycle greater than 2% and a frequency greater than 50 Hz. Autoscale is operative only for relatively stable input signals.

Save/Recall: Up to ten front-panel setups may be saved in non-volatile memory.

Preset Reflection Channel: Sets up the instrument for making TDR measurements.

Documentation Aids

Waveforms, scaling information and measurement results can be transferred directly to HP-GL compatible digital plotters and HB-IB raster graphics printers, including the HP 2255A ThinkJet[®] printer and the HP 3630A printer.

Digitizer

Converter: 12-bit successive approximation A/D converter.

Resolution: The useable full-scale range of the A/D is 640 mV. One LSB of the A/D converter equals 250 μ V. This gives one part in 2560 or slightly more than 11 bits of resolution. Averaging can extend the resolution to 32 μ V. This increased resolution, of around 14 bits, can be seen at more sensitive ranges or over HP-IB.

Digitizing Rate: The signal is sampled and digitized at a rate dictated by the trigger repetition rate, the time base range, the display mode, and the number of channels turned on. If data acquisition is not trigger rate limited, the actual sampling and digitizing rate will vary within the following range:

- a. Maximum of 10k samples per second at 10 ns/div or faster with one channel on while in infinite persistence display mode.
- b. Minimum of 1k samples per second at timebase ranges of 46 m s/div or slower regardless of number of channels turned on or the display mode.

A typical sample rate is 4500 samples per second.

General Characteristics

Environmental Conditions

Temperature:

Operating: + 15° C to + 35° C (+ 59° F to + 95° F).

Non-operating: - 40° C to + 70° C (- 40° F to + 158° F)

Humidity:

Operating: Up to 90% relative humidity at + 35° C (+ 95° F)

Non-operating: Up to 95% relative humidity at + 65° C (+ 149° F)

Altitude:

Operating: Up to 4600 metres (15,000 ft)

Non-operating: Up to 15,300 metres (50,000 ft)

Vibration:

Operating: Random vibration 5-500 Hz 10 minutes per axis, ~ 0.3 g (rms).

Non-operating: Random vibration 5-500 Hz, 10 minutes per axis, = 2.41 g (rms); and swept sine resonant search, 5-500 Hz, 0.75 g (0-peak), 5 minute resonant dwell @ 4 resonances per axis.

Power Requirements

Power requirements listed are for the combined HP 54121T system. The HP 54121A Four Channel Test Set draws its power over the provided interface cable from the HP 54120B Digitizing Oscilloscope Mainframe.

Voltage: 115/230 V ac, - 25% to + 15%, 48-66 Hz
Power: 200 watts, 400 VA maximum

Weight

HP 54120B Net: Approximately 20.5 kg (45 lb)
HP 54121A Net: Approximately 3.2 kg (7 lb)
Combined Shipping Weight: Approximately 28.2 kg (62 lb)

Dimensions

Refer to outline drawings below.

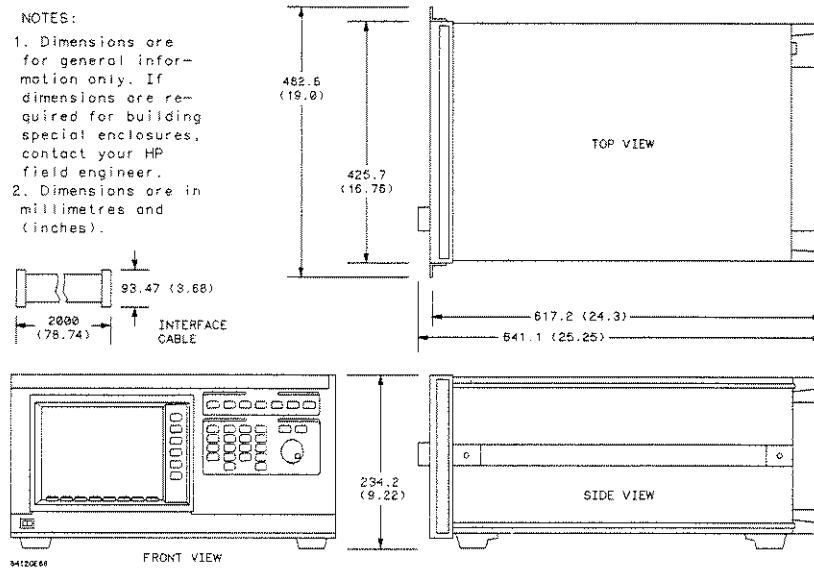

Figure 19-1. 54120B Dimensions

NOTES:

1. Dimensions are for general information only. If dimensions are required for building special enclosures, contact your HP field engineer.
2. Dimensions are in millimetres and (inches).

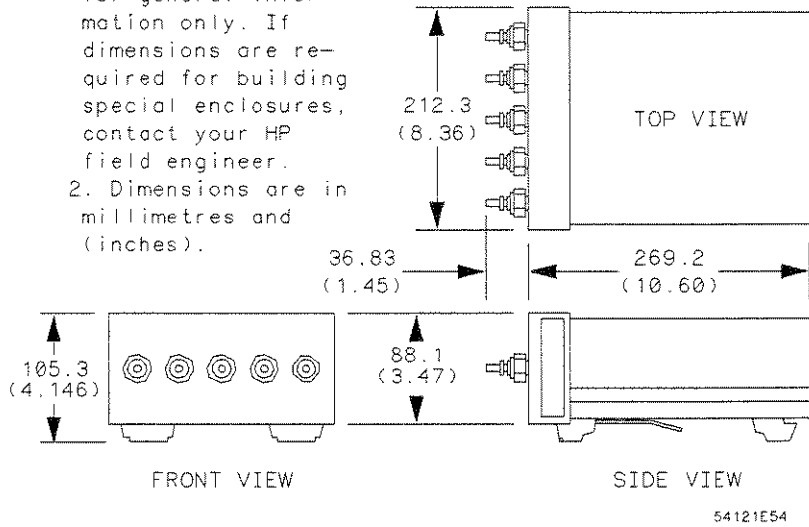

Figure 19-2. Four Channel Test Set dimensions

A

Errors, Messages, and Prompts

This appendix lists errors, messages, and prompts that occur with illegal operations, certain system events, or when user action is required so the instrument can complete a task.

All messages except one are listed in the waveform display area. The exception is the Re-Cal warning message, which is listed at the top of the display.

The alphabetical listing contains a complete definition of the message or prompt.

Message	Definition
©1987 Hewlett Packard Co. Powerup Self test Passed! Failed!	Tells you whether the instrument has passed or failed the automatic self-test cycle that occurs when power is cycled. If the power-up self test fails, refer to the HP 54120 Series service documentation.
Calibration aborted - no edge found	Informs you that the oscilloscope cannot find the pulse edge required for the calibration. To continue adjust the display scaling so the edge is on screen.
Calibration aborted - Signal clipped	Indicates that the cal signal is off screen when displayed at 80 mV/div. To continue with the cal, adjust the display scaling so that the entire cal signal can be viewed using 80 mV/div.
Calibration aborted	Indicates that an in-process cal has been terminated. This is usually caused by the operator changing the front-panel setup.

Cal only valid at
ns/div, ms/delay, &
12.4/20 GHz BW

Lists the TIME/DIV, timebase
DELAY, and bandwidth that must be
used to validate the last Trans Cal
or Reflect Cal when a waveform is
being normalized.

Connect 50 Ω at ref plane
and press Reflect Cal key
again

This prompt tells you what action
to take to complete the Reflect Cal.

Connect reference path to
channel 4 and press Trans
Cal again

This prompt tells you what action
to take to complete the Trans Cal.

Connect short at ref plane
and press Reflect Cal key
again

This prompt tells you what action
to take to continue the Reflect Cal.

Delay out of range for
Sweep speed...Set to limit

Informs you that you have attempted
to display a portion of the waveform
too close or too far from the trigger
event and the oscilloscope has set
the delay to the limit.

Disconnect signal from
channel 4 and press Trans
Cal again

This prompt tells you what action
to take to continue Trans Cal.

Disconnect all inputs and
then press key again

This prompt tells you what action
to take to continue Vertical Cal. All
inputs must be disconnected
including the trigger.

Edges required for
measurement not found

Informs you that the waveform
edges for automatic measurements
cannot be located. Edges of interest
must be on screen.

Entry Devices unassigned in
this menu

This message appears if you attempt
to use any of the entry devices (the
knob, keypad, or step keys) when
they are unassigned.

Front panel calcs lost! Re-cal thru Utility menu	This prompt tells you that the cal factors have been lost. This prompt will stay on screen until a vertical cal has been completed. Skew calcs are also lost.
Functions Min & Max must be OFF to enter averaged mode	Indicates that the Min and/or Max waveform math functions are selected and must be turned off before the averaged display mode can be used.
Key not defined...ignored	Informs you that the function key that was just pressed is not defined and no action will be taken.
Key not allowed during output...Ignored	Informs you that a key was pressed during a printer or plotter output.
Measurement aborted	Indicates that a process or measurement has terminated before completion. This is normally caused by the user changing a front-panel setting.
Min and Max allowed only in persistence display mode	Informs you that the instrument is in the averaged display mode and must be changed to the persistence display mode before the Min and/or Max waveform math functions can be selected.
No Signal Found	Indicates that no signal was detected during an AUTOSCALE cycle. Trigger was located.
No Trigger Found	Indicates that no trigger was detected during an AUTOSCALE cycle. Autoscale was aborted before vertical signal search was attempted.
No data between limits ..key ignored	Indicates that no data has been acquired between the histogram window markers.

No digits present ...value not entered	Tells you that you have pressed an ENTER key without first entering some digits from the number pad.
No setup saved here ...Recall ignored	Informs you that a front-panel setup does not exist in the selected recall register.
No valid data ...key ignored	This message is displayed if you attempt to turn on the histogram display before data is acquired.
Only digits 0-9 and clear allowed...key ignored	This message is displayed if the instrument is expecting an input from the entry devices and certain other keys are pressed. If you press Save/Recall, you must enter number or press clear before you may continue.
Reflection path must be Calibrated	This message is displayed if you attempt to use the network CURSOR before a Reflect Cal is performed.
Reflection path must be Calibrated to Normalize	This message is displayed if you attempt to normalize a waveform (Network menu) before a Reflect Cal is performed.
Reflection channel must be on to Normalize	This message is displayed if you attempt to normalize a waveform (Network menu) when the Reflect Chan is not turned on.
Scope in remote...key ignored	This message is displayed if you attempt to operate the oscilloscope from the front panel and it is under remote control.
Set TIME/DIV for adequate time resolution	This prompt suggests that you use a smaller TIME/DIV setting when using the waveform math versus function. This will provide a more detailed display.

Setup Recalled	Shows you that you have successfully recalled a front-panel setup.
Setup Saved	Shows you that you have successfully saved a front-panel setup.
Signal clipped	Tells you that the waveform was clipped when you attempted to use any of the automatic measurements from the Measure menu. Rescale the VOLTS/DIV and OFFSET so the waveform is on screen.
Software error	Informs you a software error has occurred over the HP-IB.
Step and Freerun on ...key ignored	Informs you that the TDR pulse and the Freerun trigger are on if you attempt to change any trigger parameters.
Transmission path must be Calibrated	Informs you that a Trans Cal must be performed before the network CURSOR can be used.
Transmission path must be Calibrated to Normalize	Informs you that a Trans Cal must be performed before a waveform can be normalized.
Transmission channel must be turned on	Informs you that channel 4 must be turned on to normalize a waveform in the Trans submenu (part of Network menu).
Value out of range ...set to limit	Indicates that the value you have just entered is beyond the limit of the selected variable.
Warning: Scope not in talk only	This warning appears if you attempt to print or plot a waveform and the HPIB status is not set to "talk only." HPIB submenu is part of the Utility menu.

Warning: Unable to
cal Ch1 Ch2 Ch3 Ch4

This warning tells you that the oscilloscope was unable to automatically calibrate the Channel Vertical Cal (Utility menu). Channel may still be connected to a source; otherwise, there is a hardware failure.

Handling and Care of Precision Connectors

B

3.5 mm Connector Care

Appendix B shows you how to take care of 3.5 mm connectors so that you can maintain high levels of accuracy, repeatability, and system performance. Taking appropriate care of your connectors will also extend their service life.

Connector Wear

Connector wear will eventually degrade performance. The calibration devices, which are typically used only a few times each day, should have a very long life. However, because the connectors often undergo many connections a day, they wear rapidly. Therefore, it is essential that all connectors on the HP 54120 system be inspected regularly, both visually (with a magnifying glass) and mechanically (with a connector gage), and replaced as necessary. Procedures for visual and mechanical inspection are given in the next section of this manual. For four channel test sets used in high-volume work, it is best to place an adapter on both the input and the output ports. It is easier and cheaper to replace a worn adapter than a worn four channel test set connector.

Operator Skill

Operator skill in making good connections is essential. The mechanical tolerances of the precision 3.5 mm connectors used in the HP 54007A kit are two or three times better than the tolerances in regular 3.5 mm connectors. Slight errors in operator technique that would go unnoticed with regular connectors often appear with precision connectors in the calibration kit. Incorrect operator technique can often result in lack of repeatability. Carefully study and practice the connection procedures that are explained later in this manual until your calibration measurements are consistently repeatable.

Device Specifications

Electrical specifications depend upon several mechanical conditions. A 3.5 mm connector is a precision connector dedicated to very specific tolerances. SMA connectors are not precision mechanical devices. They are not designed for repeated connections and disconnections and are very susceptible to mechanical wear. They are often found, upon assembly, to be out of specification. This makes them potentially destructive to any precision 3.5 mm connectors with which they might be mated.

CAUTION

Use extreme caution when mating SMA connectors with 3.5 mm precision connectors. Prevent accidental damage due to worn or out-of-specification SMA connectors. Such connectors can destroy a precision 3.5 mm connector, even on the first connection.

Hewlett-Packard recommends that you keep three points clearly in mind when you mate SMA and precision 3.5 mm connectors:

SMA Inspect

1. Before mating an SMA connector (even a new one) with a precision 3.5 mm connector, carefully inspect the SMA connector, both visually and mechanically with a precision connector gauge designed to measure SMA connectors. A male SMA connector pin that is too long can smash or break the delicate fingers on the precision 3.5 mm female connector. Gauging SMA connectors is the most important step you can take to prevent damaging your equipment.

Alignment

2. Be careful with alignment. Push the two connectors together with the male contact pin precisely concentric with the female. Do not overtighten or rotate either center conductor. Turn only the outer nut of the male connector and use a torque wrench (5 lb.in., 60 N-cm) for the final connection. Note that this torque is less than that when mating precision 3.5 mm connectors with each other. A torque wrench suitable for SMA connectors preset to 5 lb.in. is available (HP part number 8710-1582, CD 0).

Install an adapter on the four channel test set if many connections and disconnections will be made. Then, if accidental damage does occur, the adapter is all that needs to be replaced. It is easier and cheaper to replace a damaged adapter than an entire four channel test set connector. SMA connectors can then be mated with precision 3.5 mm connectors without difficulty or fear of expensive and time-consuming repairs.

Mechanical Mismatch

3. Significant structural and dimensional differences exist between these two types of connectors. Precision 3.5 mm connectors, also known as APC-3.5 connectors, are air-dielectric devices. Only air exists between the center and outer conductors. The male or female center conductor is supported by a plastic "bead" within the connector. In SMA connectors, a plastic dielectric supports the entire length of the center conductor. In addition, the diameter of both the center and outer conductors of an SMA differ from that of a precision 3.5 mm connector.

If these precautions and recommendations are followed, SMA connectors can be mated with 3.5 mm precision connectors without fear of expensive and time consuming repairs.

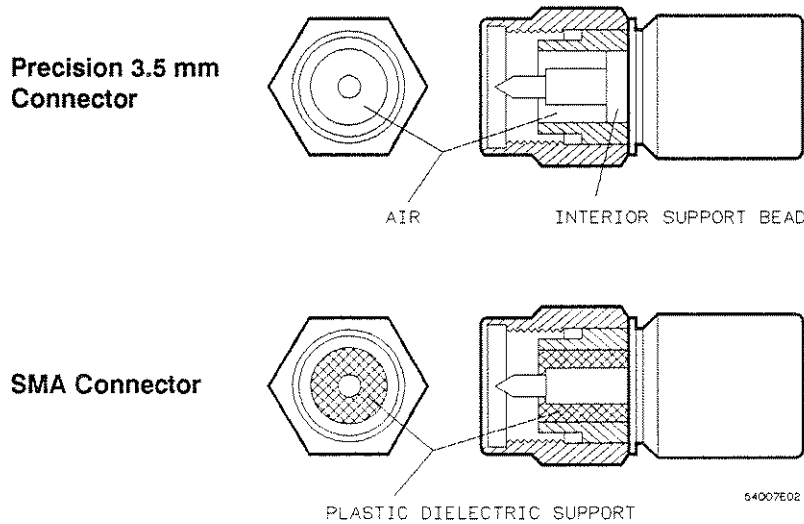

Figure B-1. SMA and Precision 3.5 mm Connectors

When an SMA connector is mated with a precision 3.5 mm connector, the connection exhibits a continuity mismatch (SWR), typically about 1.10 at 20 GHz. This mismatch is less than when precision 3.5 mm connectors are mated. Keep this fact in mind when making measurements on SMA and precision 3.5 mm coupled junctions.

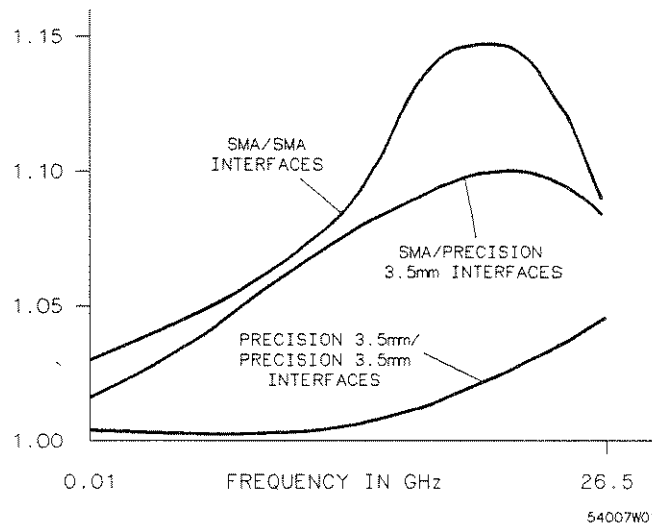

Figure B-2. Typical SWR of SMA and 3.5 mm Connectors

Accuracy Considerations

Accuracy requires that 3.5 mm precision connectors be used. However, SMA connectors can be used if special care is taken when mating the two, and all connectors are undamaged and clean. Before each use, the mechanical dimensions of all connectors must be checked with a connector gauge to make sure that the center conductors are positioned correctly. All connections must be made for consistent and repeatable mechanical (and therefore electrical) contact between the connector mating surfaces.

Carefully study and practice all procedures in this chapter until you can successfully perform them repeatedly. Accuracy and repeatability are critical for good microwave measurements. Note that the device connection procedures differ in several important ways from traditional procedures used in the microwave industry. Hewlett-Packard procedures have been developed through careful experimentation.

Handling Precision 3.5 mm Connectors

Precision 3.5 mm connectors must be handled carefully if accurate calibrations and measurements are to be obtained.

- Store the devices in the foam-lined storage case when not in use.
- Avoid bumping or scratching any part of the mating surfaces.
- Be careful to align the center connectors. Check the alignment carefully before tightening the connector nuts.
- Use a torque wrench for all final connections in order to avoid overtightening.
- Support the devices being used in order to avoid vertical or lateral force on any connectors. This precaution is critical when using the airline, 6 cm "L", or cables.

When Disconnecting Devices:

- Do not rock or bend any connections.
- Pull the connector straight out without unscrewing or twisting.
- Before storage, screw the connector nut all the way out to help protect the surfaces, and use the plastic caps provided. These plastic caps can be taken off easily by unscrewing, rather than pulling.

CAUTION

Do not use a damaged or defective connector. It will damage any good connector to which it is attached. Throw the connector away or have it repaired.

A connector is bad if it fails either the visual or mechanical examinations or when an experienced operator cannot make repeatable connections. The time and expense involved in replacing four channel test set connectors warrants considerable caution when any connector might be less than perfect.

If any doubts exist about a connector, call your Hewlett-Packard representative. Hewlett-Packard field offices offer limited professional advice and have access to the factory for information.

Visual Inspection and Cleaning

Always begin a calibration with a careful visual inspection of the connectors, including the test set connectors to make sure they are clean and undamaged.

CAUTION

Make sure that you and your equipment are grounded before touching any center conductor so you won't cause static electricity and create a potential for electrostatic discharge. When using or cleaning connectors on the test set, be aware that you are touching exposed center connectors that are connected directly to the internal circuits of the oscilloscope. Touching the center conductor, especially with a wiping or brushing motion, can cause an electrostatic discharge (ESD) and severely damage these sensitive circuits.

Visual Inspection

Use an illuminated, 4-power magnifying glass for visual inspection.

1. Before you begin, make sure you and any equipment you are using are grounded to prevent electrostatic discharge.
2. Examine the connectors first for obvious problems, such as deformed threads, contamination, or corrosion.

3. Next concentrate on the mating surfaces of each connector. Look for scratches, rounded shoulders, misalignment, or any other signs of wear or damage.
4. Make sure that the surfaces are clean, free of dust and solvent residues.

Dirt or damage visible with a 4-power magnifying glass can cause degraded electrical performance and possible connector damage. All connectors should be repaired or discarded immediately.

Cleaning

Cleaning the connectors is seldom necessary. Dust or dirt on the connector surfaces can be brushed or wiped away gently with a plastic foam swab or low-pressure, clean, compressed air. Be sure you and all cleaning equipment are grounded to avoid electrostatic discharge.

If necessary, liquid Freon (trichlorotrifluoroethane), HP part number 8500-1914 CD 7, is the only cleaning solvent recommended by Hewlett-Packard for cleaning 3.5 mm connectors. Several types of liquid Freon exist, so make sure that the kind you use contains only trichlorotrifluoroethane. Some other types contain harmful compounds which can damage precision 3.5 mm connectors. Using the solvent in liquid is preferred because the liquid can be applied sparingly and selectively. If spray must be used, spray the cleaning swab only, not the connector. Use a microscope slide, or similar piece of clear glass to check the solvent periodically for contamination. Refer to figure B-3.

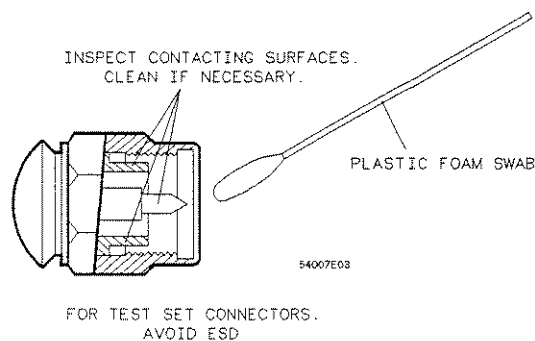

Figure B-3: Visual Inspection of 3.5 mm Connectors

CAUTION

Do not, under any circumstances, use abrasives (not even pencil eraser) or any solvent other than trichlorotrifluoroethane. Residue can be left behind that can damage the metal connector surfaces and the plastic conductor supports.

When you are satisfied that all the connectors are clean and undamaged, you can proceed to the mechanical inspection of connector dimensions.

Mechanical Inspection

Mechanical inspection of the connectors is the next step. This inspection consists of using the appropriate male or female precision 3.5 mm connector gauge to check the mechanical dimensions of all connectors, including those on the test set. The purpose of doing this is to make sure that perfect mating will occur between the connector surfaces. Perfect mating assures a good electrical match and is very important mechanically to avoid damaging the connectors themselves, especially on the oscilloscope.

Center Conductor

The critical dimension to be measured is the recession of the center conductor. This dimension is shown as MP and FP in Figure B-4 and B-5. No protrusion of the center conductor's shoulder is allowable on any connector. The maximum allowable recession of the center conductor shoulder is 0.003 in. (0.08 mm) on all connectors, except those on the four channel test sets.

On the four channel test set connectors, not only is no protrusion allowable, the shoulder of the center conductor must be recessed at least 0.0002 in. (0.005 mm). The maximum allowable recession of the center conductor shoulder on the four channel test set connectors is 0.0021 in. (0.056 mm).

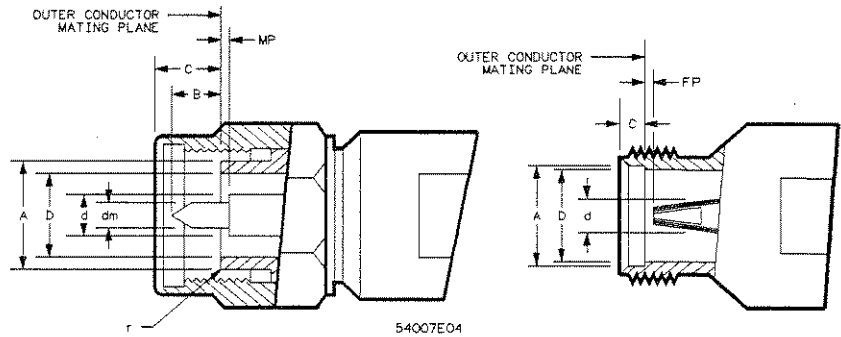

- D = inside diameter of the outer conductor
- d = diameter of male/female center connector
- A = outside diameter of outer conductor at the mating plane
- r = corner relief for male connector
- B = protrusion of the male contact pin tip beyond the outer conductor mating plane
- C = recession of the outer conductor mating plane behind outer face of connector
- MP = recession of male contact pin shoulder behind outer conductor mating plane

Male Connectors	Female Connectors	Male Connectors	Female Connectors
D = 0.1378 ± 0.0005 in 3.500 ± 0.013 mm	D = 0.1378 ± 0.0005 in 3.500 ± 0.013 mm	B = 0.085 in 2.16 mm	N/A
d = 0.0598 ± 0.0003 in 1.519 ± 0.008 mm	d = 0.0598 ± 0.0003 in 1.519 ± 0.008 mm	C = 0.120 ± 0.015 in 3.05 ± 0.38 mm	C = 0.176 ± 0.002 in 1.93 ± 0.05 mm
A = 0.1803 in 4.580 mm	A = 0.1807 in 4.590 mm	MP = 0.000 in mm	FP = 0.000 in mm
r = 0.003 in 0.08 mm	r = 0.003 in 0.08 mm	dm = 0.037 in 0.94 mm	N/A

Figure B-4. Mechanical Dimensions of Connector Faces

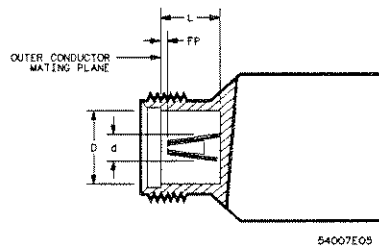
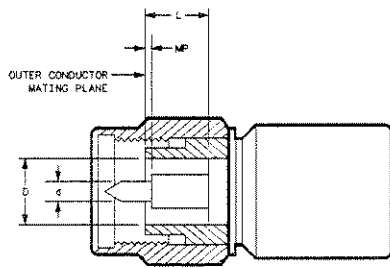

D = inside diameter of outer conductor =	0.1378 ± 0.0003 in 3.500 ± 0.008 mm
d = diameter of center conductor =	0.0598 ± 0.0002 in 1.519 ± 0.005 mm
MP = recession of center conductor shoulder =	$0.000 + 0.000 / -0.003$ in $0.00 + 0.00 / -0.08$ mm
FP =	
L = length of outer conductor =	0.197 ± 0.001 in 0.00 ± 0.000 mm
C = concentricity of contact is governed by mating connector: typically, 0.003 FIM (TIR)	

Figure B-5. Mechanical Dimensions of the Short Circuit

Outer Conductor

If any contact protrudes beyond the outer conductor mating plane, the contact is out of tolerance and must be replaced. If the center conductor is not recessed at least 0.0002 in. (0.005 mm), it is out of tolerance and must be replaced. In both cases the out-of-tolerance connector will permanently damage any connector attached to it. Destructive electrical interference will also result due to buckling of the female contact fingers. This is often noticeable as a power hole several dB deep occurring at about 22 GHz.

If any contact is recessed too far behind the outer conductor mating plane (0.0021 in. 0.056 mm, except in test sets), poor electrical contact will result, causing high electrical reflections. Careful gauging of all connectors will help prevent this condition.

Before using the connector gauge to measure the connectors, visually inspect the end of the gauge and the calibration block in the same way that you inspected the connectors. Dirty or damaged gauge facings can cause dirty or damaged connectors. Two connector gauges are available from Hewlett-Packard, one for each connector type, male and female. Refer to figure B-6. A single gauge calibration block is used to zero both gauges; one end protrudes for zeroing the male connector gauge. The part number for both gauges, as well as the calibration block is 85052-80010.

Figures B-7 to B-9 show how to use the connector gauges. Zero the gauge with the calibration block. Refer to figure B-7. It is recommended that you zero both gauges first, then measure each of the terminations and/or adapters that will be used. Then, as the last step, measure the test set connectors.

Figures B-8 and B-9 show how to measure precision 3.5 mm connectors. Note that a plus (+) reading on the gauge indicates recession of the center conductor and a minus (-) reading indicates protrusion. Since no protrusion of either connector is allowable, readings for connectors within the allowable range will be on the plus (+) scale of the gauge. Also note that the allowable tolerance range for the test set connectors is different from the range for other connectors. Both ranges are shown in Figures B-8 and B-9. Before measuring test set connectors, be sure that the power to the test set is off and that you and your equipment are grounded to prevent electrostatic discharge.

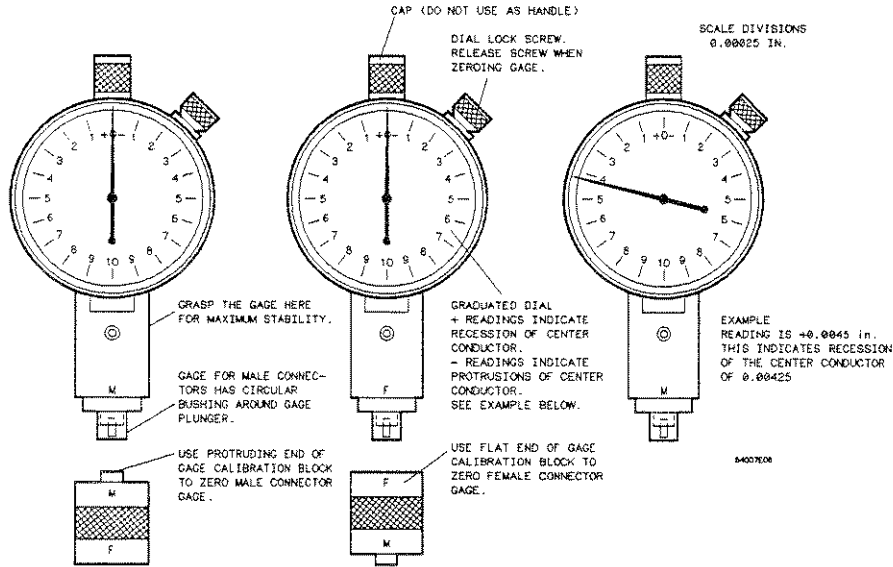

Figure B-6. Precision 3.5 mm Connector Gauges

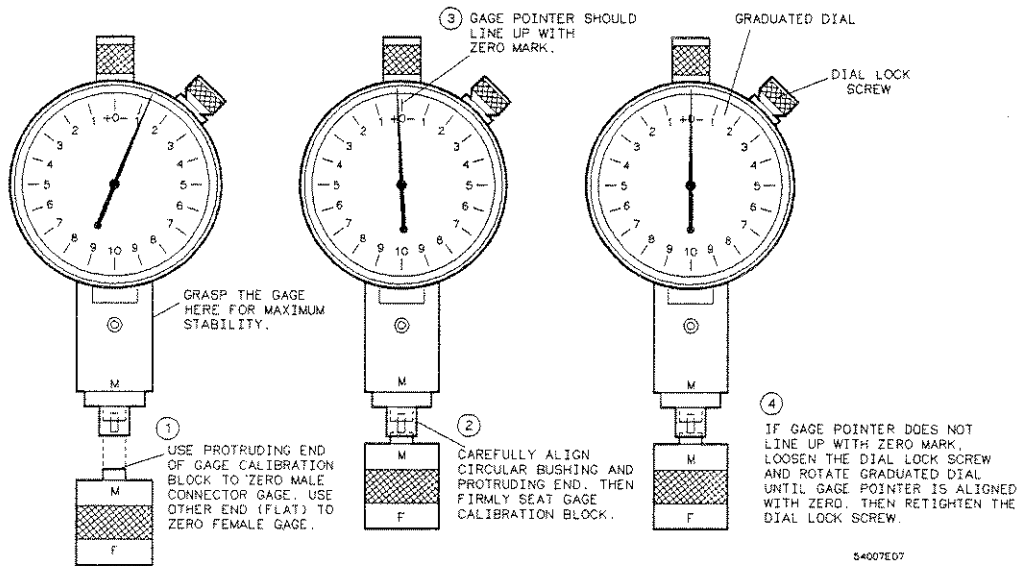

Figure B-7. Zeroing Precision 3.5 mm Connector Gauges

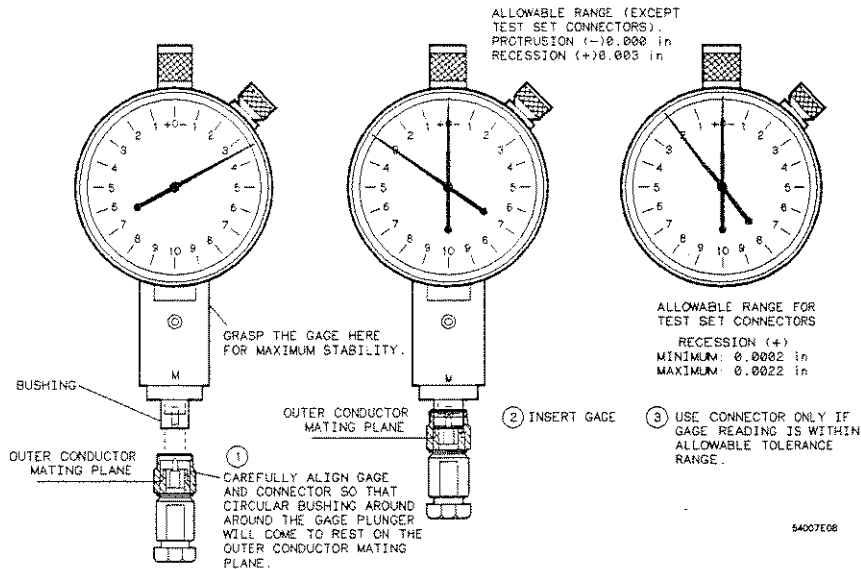

Figure B-8. Measuring Precision 3.5 mm Male Connectors

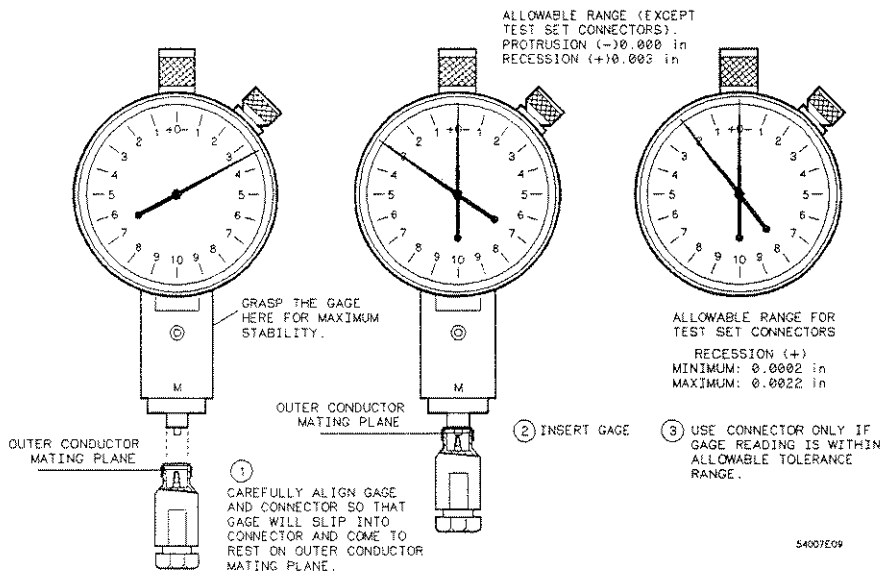

Figure B-9. Measuring Precision 3.5 mm Female Connectors

Connecting the Devices

Figures B-10 and B-11 illustrate the Hewlett-Packard recommended procedures for making connections with the calibration devices. Notice that these recommended procedures differ from traditional procedures used in the microwave industry, especially the counter-rotation technique and procedure for connecting the airline.

The counter-rotation technique, recommended here, involves a slight rotation of the termination or adapter just before the final tightening of the connector nut. This eliminates the very small air wedge between the outer conductors that frequently occurs when the body is held stationary during tightening, as it is in the traditional procedure. The HP 54120 system will detect the reflections caused by such small wedges.

The counter-rotation technique does not harm the connectors. The gold plating on the outer conductor surface will become burnished in time. This is normal, and as long as the surface remains smooth, the connector is still good. After much use the gold plating may eventually wear through and expose the beryllium-copper substratum. This too is normal, and if it is smooth the connector is still good, although the beryllium-copper surface may oxidize if the connector is used infrequently.

If the burnished surface is rough, scratched, rippled, or has other irregularities, too much tightening force is being used. If the roughness is severe, the connector is ruined and should not be used.

CAUTION

Damage can result if SMA connectors are overtightened to precision 3.5 mm connectors. Use a torque wrench designed for SMA connectors, set to a 5 in lb (60 N/cm). A torque wrench suitable for SMA connectors is available, HP part number 8710-1582.

Counter-Rotation Technique

The recommended Hewlett-Packard counter-rotation technique is for precision 3.5 mm connectors. Before making any connections to the test set, ground yourself with a grounded wrist strap. Also, it is good practice to grasp the outer shell of the test port before you make any connections to the test set in order to discharge any static electricity on your body. This is the most effective single safeguard to prevent ESD damage to your instruments.

1. If the device has a retractable connector nut, fully retract the nut before mating the connectors. Carefully align the male and female contact pins and slide the connectors straight together until the center and the two outer conductors meet. Be careful not to twist or bend the contact pins. You should feel a slight resistance as the connectors mate.
2. Make the preliminary connection by attaching the connector nut of the male connector to the female. The male connector is held stationary as the female connector is tightened and draws the male pin into the female connector. Refer to figure B-10. Any other method used may cause the male pin to damage the female connector. Support the body of the device and turn the connector nut until the mating surfaces make light contact. Do not overtighten. All you want is a connection of the outer conductors with gentle contact at all points of both mating surfaces.

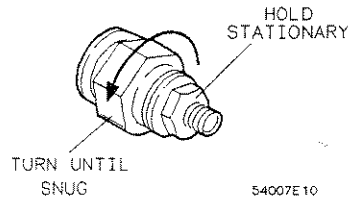

Figure B-10. Connecting 3.5 mm Devices

3. When you are satisfied with this preliminary connection, use the following counter-rotation technique to eliminate air wedges between the mating planes. Refer to figure B-11. If the calibration device is male, hold the connector nut firmly. Very slowly rotate the body of the device about 10-20° counterclockwise. Note that this slight rotation or backwiping is sufficient. Greater rotation does not improve electrical performance and increases wear on the connector surfaces. If the calibration device is female (the connector nut is on the test set), very slowly rotate both the connector nut and the body of the device clockwise 10-20° (counterclockwise rotation will loosen the connection).

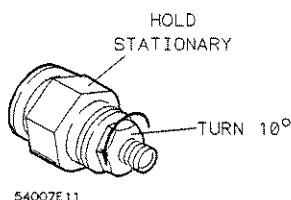

Figure B-11. Counter-Rotation Technique

Light, smooth frictional resistance felt during the counter-rotation indicates you have made the preliminary connection correctly and that the counter-rotation technique has been successful. Roughness felt during counter-rotation indicates either that the connectors are damaged or that there is roughness in the connector nut/thread contact. Inspect both connectors again before proceeding, to make sure that the roughness is due to roughness in the connector nut interface rather than on the connector mating planes.

4. Tighten the connector nut finger tight, allowing the device to turn with the nut if it tends to do so. A small rotation of the body of the device at this point is acceptable and tends to occur naturally.
5. Use a torque wrench to make the final connection. Use of the torque wrench assures the final connection will be tight enough for optimum electrical performance, but not so tight as to distort or damage the connectors.

To disconnect, follow this procedure:

1. Loosen the connector nut on the male connector with the torque wrench. Leave the connection finger tight.
2. While supporting the calibration device, gently unfasten the connectors and pull the calibration device straight out of the test port connector. Do not twist either the center conductor or the outer conductor housing or exert lateral or vertical (bending) force on the connection.

Some precision 3.5 mm female connector fingers are very tight and can pull the center pin of their mates out past specifications as they are disconnected. If such a male pin is inserted into a female connector, it can cause considerable damage by pushing the female center conductor back too far. Be aware of this possibility and check all connectors before mating them again.



TDR Fundamentals

C

Introduction

The most common method for evaluating a transmission line and its load has traditionally involved applying a sine wave to a system and measuring waves resulting from discontinuities on the line. From these measurements, the standing wave ratio (σ) is calculated and used as a figure of merit for the transmission system. When the system includes several discontinuities, however, the standing wave ratio (SWR) measurement fails to isolate them. Consider a case where the load is well matched to the transmission line (i.e., $Z_L = Z_0$) but several connector joining segments of the line act as minor discontinuities — this is a realistic situation since BNC connectors, for example, will typically look like small inductors in series with the line. The SWR measurement does not single out the component or components causing the discontinuity; it only indicates their aggregate effect. Any attempt to improve the system, therefore reduces to a trial and error substitution of components. In addition SWR techniques fail to demonstrate whether one discontinuity is generating a reflection of the proper phase and magnitude to cancel (at a particular frequency) the reflection from a second discontinuity. When the broadband quality of a transmission system is to be determined, SWR measurements must therefore be made at many frequencies, and this method soon becomes very time consuming and tedious.

Time domain reflectometry avoids all of these disadvantages of the SWR method. TDR, as it is commonly abbreviated, employs a step generator and an oscilloscope in a system best described as "closed-loop radar." A voltage step is propagated down the transmission line under investigation, and the incident and reflected voltage waves are monitored by the oscilloscope at a particular point on the line.

*Portions of this Appendix are Reprinted
from Application Note 62.
Modifications have been made to
represent the HP 54120 Series Digitizing
Oscilloscopes with TDR capability*

HP 54121T
Front-Panel Reference

TDR Fundamentals
C-1

This echo technique (see figure C-1) reveals at a glance the characteristic impedance of the line, and it shows both the position and the nature (resistive, inductive, or capacitive) of each discontinuity along the line. TDR also demonstrates whether losses in a transmission system are series losses or shunt losses. All of this information is immediately available from the oscilloscope's display. TDR also gives more meaningful information concerning the broadband response of a transmission system than any other measuring technique.

Since the basic principles of time domain reflectometry are easily grasped, even those with limited experience in high frequency measurements can quickly master this technique. This appendix attempts a concise presentation of the fundamentals of TDR and then relates these fundamentals to the parameters that can be measured in actual test situations. Before discussing these principles further we will briefly review transmission line theory.

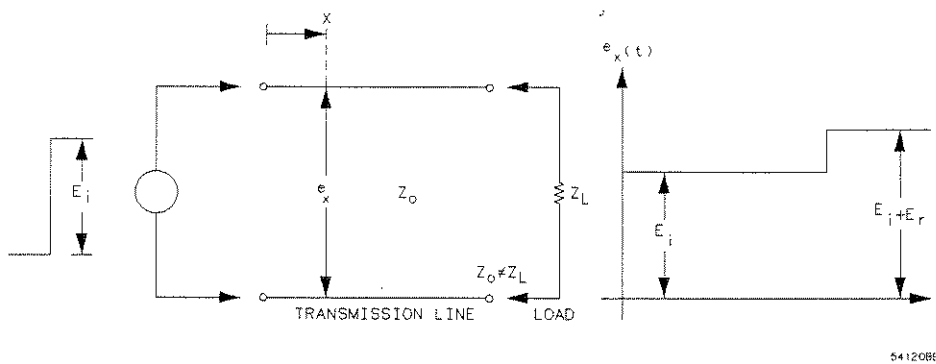

Figure C-1. Voltage vs Time at a Particular Point on a Mismatched Transmission Line Driven with a Step of Height E_i

Propagation on a Transmission Line

The classical transmission line is assumed to consist of a continuous structure of R's, L's and C's, as shown in figure C-2. By studying this equivalent circuit, several characteristics of the transmission line can be determined.

If the line is infinitely long and R, L, G, and C are defined per unit length, then

$$Z_{in} = Z_0 = \sqrt{\frac{R + j\omega L}{G + j\omega C}}$$

where Z_0 is the characteristic impedance of the line. A voltage introduced at the generator will require a finite time to travel down the line to a point x. The phase of the voltage moving down the line will lag behind the voltage introduced at the generator by an amount β per unit length. Furthermore, the voltage will be attenuated by an amount α per unit length by the series resistance and shunt conductance of the line. The phase shift and attenuation are defined by the propagation constant γ , where

$$\gamma = \alpha + j\beta = \sqrt{(R + j\omega L)(G + j\omega C)}$$

α = attenuation in nepers per unit length

β = phase shift in radians per unit length

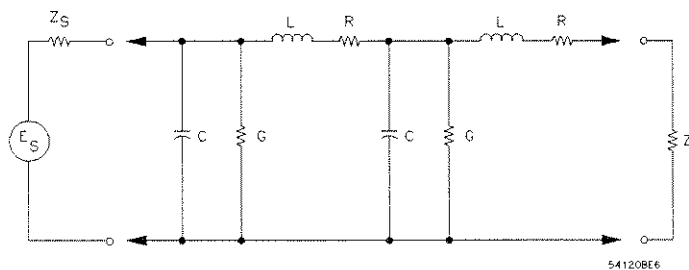

Figure C-2. The Classical Model for a Transmission Line.

The velocity at which the voltage travels down the line can be defined in terms of β :

$$v_p = \frac{\omega}{\beta} \text{ UNIT LENGTH PER SECOND}$$

The velocity of propagation approaches the speed of light, v_c for transmission lines with air dielectric. For the general case where ϵ_r is the dielectric constant.

$$v_p = \frac{v_c}{\sqrt{\epsilon_r}}$$

The propagation constant γ can be used to define the voltage and the current at any distance x down an infinitely long line by the relations

$$E_x = E_{in}e^{-\gamma x} \text{ AND } I_x = I_{in}e^{-\gamma x}$$

Since the voltage and the current are related at any point by the characteristic impedance of the line

$$Z_o = \frac{E_{in}e^{-\gamma x}}{I_{in}e^{-\gamma x}} = \frac{E_{in}}{I_{in}} = Z_{in}$$

When the transmission line is finite in length and is terminated in a load whose impedance matches the characteristic impedance of the line, the voltage and current relationships are satisfied by the preceding equations.

If the load is different from Z_o , these equations are not satisfied unless a second wave is considered to originate at the load and to propagate back up the line toward the source. This reflected wave is energy that is not delivered to the load. Therefore, the quality of the transmission system is indicated by the ratio of this reflected wave to the incident wave originating at the source. This ratio is called the voltage reflection coefficient, ρ , and is related to the transmission line impedance by the equation:

$$\rho = \frac{E_r}{E_i} = \frac{Z_L - Z_o}{Z_L + Z_o}$$

The magnitude of the steady-state sinusoidal voltage along a line terminated in a load other than Z_0 varies periodically as a function of distance between a maximum and minimum value. This variation called a standing wave, is caused by the phase relationship between incident and reflected waves. The ratio of the maximum and minimum values of this voltage is called the voltage standing wave ratio, σ , and is related to the reflection coefficient by the equation

$$\sigma = \frac{1 + |\rho|}{1 - |\rho|}$$

As has been said, either of the above coefficients can be measured with presently available test equipment. But the value of the SWR measurement is limited. Again, if a system consists of a connector, a short transmission line and a load, the measured standing wave ratio indicates only the overall quality of the system. It does not tell which of the system components is causing the reflection. It does not tell if the reflection from one component is of such a phase as to cancel the reflection from another. The engineer must make detailed measurements at many frequencies before he can know what must be done to improve the broadband transmission quality of the system.

Step Reflection Testing

A time domain reflectometer setup is shown in figure C-3.

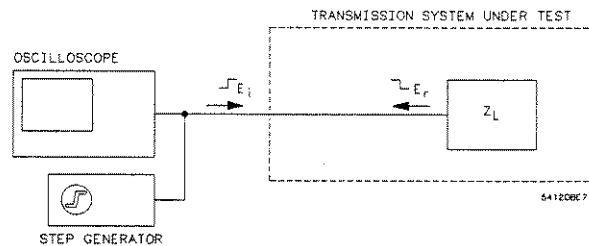

Figure C-3. A Time Domain Reflectometer

The step generator produces a positive-going incident wave that is applied to the transmission system under test. The step travels down the transmission line at the velocity of propagation of the line. If the load impedance is equal to the characteristic impedance of the line no wave is reflected and all that will be seen on the oscilloscope is the incident voltage step recorded as the wave passes the point on the line monitored by the oscilloscope. Refer to figure C-4.

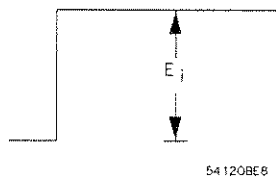

Figure C-4. Oscilloscope Display When $E_r = 0$

If a mismatch exists at the load, part of the incident wave is reflected. The reflected voltage wave will appear on the oscilloscope display algebraically added to the incident wave. Refer to figure C-5.

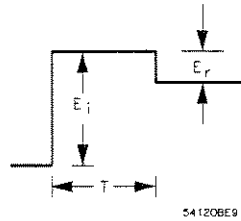

Figure C-5. Oscilloscope Display When $E_r \neq 0$

Locating Mismatches

The reflected wave is readily identified since it is separated in time from the incident wave. This time is also valuable in determining the length of the transmission system from the monitoring point to the mismatch. Letting D denote this length:

$$D = v_p \cdot \frac{T}{2} = \frac{v_p T}{2}$$

where v_p = velocity of propagation
 T = transit time from monitoring point to the mismatch and back again, as measured on the oscilloscope (figure C-5)

The velocity of propagation can be determined from an experiment on a known length of the same type of cable (e.g., the time required for the incident wave to travel down and the reflected wave to travel back from an open circuit termination at the end of a 120 cm piece of RG-9A/U is 11.4 ns giving $v_p = 2.1 \times 10^8$ cm/sec. Knowing v_p and reading T from the oscilloscope determines D . The mismatch is then located down the line.

Analyzing Reflections

The shape of the reflected wave is also valuable since it reveals both the nature and magnitude of the mismatch. Figure C-6 shows four typical oscilloscope displays and the load impedance responsible for each. These displays are easily interpreted by recalling this equation:

$$\rho = \frac{E_r}{E_i} = \frac{Z_L - Z_0}{Z_L + Z_0}$$

Knowledge of E_i and E_r , as measured on the oscilloscope, allows Z_L to be determined in terms of Z_0 , or vice versa. In figure C-6, for example, we may verify that the reflections are actually from the terminations specified.

Assuming Z_0 is real (approximately true for high quality commercial cable), it is seen that resistive mismatches reflect a voltage of the same shape as the driving voltage, with the magnitude and polarity of E_r determined by the relative values of Z_0 and R_L .

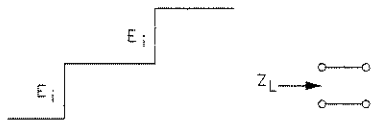

(A) OPEN CIRCUIT TERMINATION ($Z_L = \infty$)

(A) $E_r = E_i$ THEREFORE $\frac{Z_L - Z_o}{Z_L + Z_o} = +1$
 WHICH IS TRUE AS $Z_L \rightarrow \infty$
 $\therefore Z = \text{OPEN CIRCUIT}$

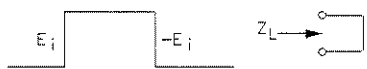

(B) SHORT CIRCUIT TERMINATION ($Z_L = 0$)

(B) $E_r = E_i$ THEREFORE $\frac{Z_L - Z_o}{Z_L + Z_o} = -1$
 WHICH IS ONLY TRUE (FOR FINITE Z_o)
 WHEN $Z_L = 0$
 $\therefore Z = \text{SHORT CIRCUIT}$

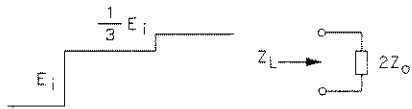

(C) LINE TERMINATED IN $Z_L = 2Z_o$

(C) $E_r = +\frac{1}{3} E_i$ THEREFORE $\frac{Z_L - Z_o}{Z_L + Z_o} = +\frac{1}{3}$
 AND $Z_L = 2Z_o$

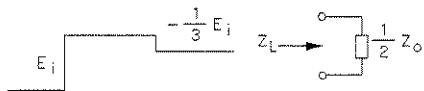

(D) LINE TERMINATED IN $Z_L = \frac{1}{2} Z_o$

(D) $E_r = -\frac{1}{3} E_i$ THEREFORE $\frac{Z_L - Z_o}{Z_L + Z_o} = -\frac{1}{3}$
 AND $Z_L = \frac{1}{2} Z_o$

54120M04

Figure C-6. TDR Displays for Typical Loads

Also of interest are the reflections produced by complex load impedances. Four basic examples of these reflections are shown in Figure C-7.

These waveforms could be verified by writing the expression for $\rho(s)$ in terms of the specific Z_L for each example:

$$\text{(i.e., } Z_L = R + sL, \frac{R}{1 + RCs}, \text{ etc.)}$$

multiplying $\rho(s)$ by $\frac{E_i}{s}$ the transform of a step function of E_i , and then transforming this product back into the time domain to find an expression for $e_r(t)$. This procedure is useful, but a simpler analysis is possible without resorting to Laplace transforms. The more direct analysis involves evaluating the reflected voltage at $t = 0$ and at $t = \infty$ and assuming any transition between these two values to be exponential. (For simplicity, time is chosen to be zero when the reflected wave arrives back at the monitoring point.) In the case of the series R-L combination, for example, at $t = 0$ the reflected voltage is $+E_i$. This is because the inductor will not accept a sudden change in current; it initially looks like an infinite impedance, and $\rho = +1$ at $t = 0$. Then current in L builds up exponentially and its impedance drops toward zero. At $t = \infty$, therefore $e_r(t)$ is determined only by the value of R.

$$\left(\rho = \frac{R - Z_0}{R + Z_0} \text{ WHEN } t = \infty \right)$$

The exponential transition of $e_r(t)$ has a time constant determined by the effective resistance seen by the inductor. Since the output impedance of the transmission line is Z_0 , the inductor sees Z_0 in series with R, and

$$\gamma = \frac{L}{R + Z_0}$$

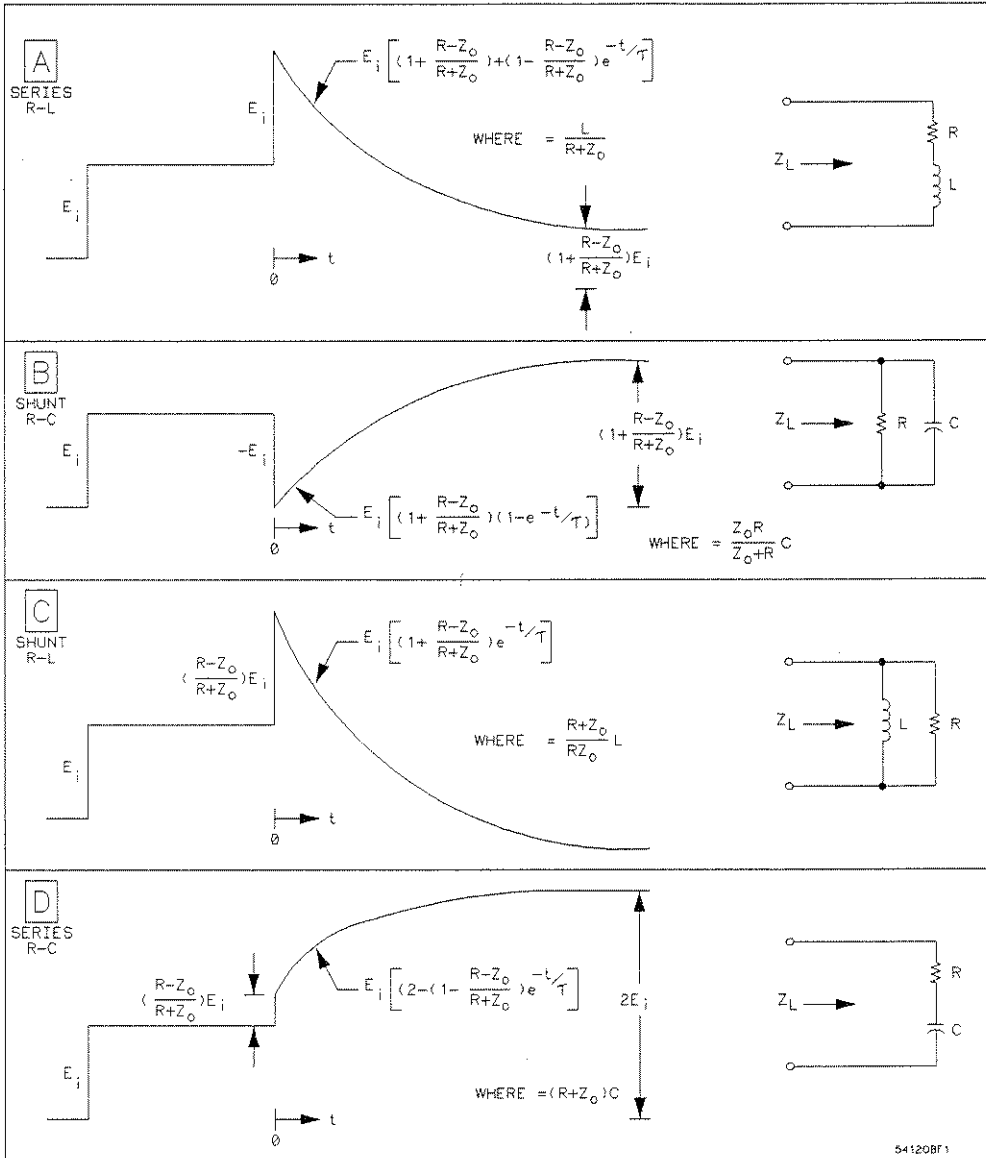

Figure C-7. Oscilloscope Displays for Complex Z_L

A similar analysis is possible for the case of the parallel R-C termination. At time zero, the load appears as a short circuit since the capacitor will not accept a sudden change in voltage. Therefore $\rho = -1$ when $t = 0$. After some time, however, voltage builds up on C and its impedance rises. At $t = \infty$, the capacitor is effectively an open circuit:

$$Z_L = R \quad \text{AND} \quad = \frac{R - Z_o}{R + Z_o}$$

The resistance seen by the capacitor is Z_o in parallel with R, and therefore the time constant of the exponential transition of $e_r(t)$ is:

$$\frac{Z_o R}{Z_o + R} C$$

The two remaining cases can be treated in exactly the same way. The results of this analysis are summarized in figure C-7.

Measuring the Time Constant of the Reflected Wave from Complex Loads

When one encounters a transmission line terminated in a complex impedance, determining the element values comprising Z_L involves measuring two things:

1. Either $e_r(t)$ at $t = 0$ or at $t = \infty$ and
2. The time constant of the exponential transition from $e_r(0)$ to $e_r(\infty)$.

Number 1 is a straight forward procedure from the information given in Figure C-7. Number 2 is most conveniently done by measuring the time to complete one half of the exponential transition from $e_r(0)$ to $e_r(\infty)$. The time for this to occur corresponds to 0.69τ , where τ denotes the time constant of the exponential. Adjusting the vertical sensitivity of the oscilloscope in the TDR system so that the exponential portion of the reflected wave fills the full vertical dimension of the graticule makes this measurement very easy (figure C-8).

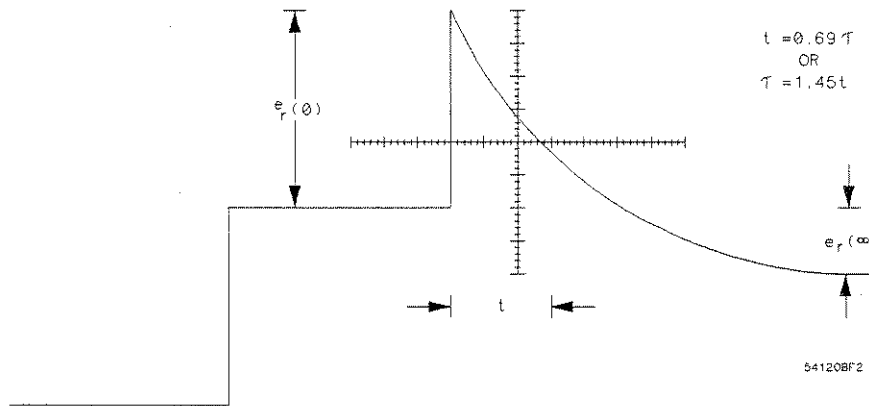

Figure C-8. Determining the Time Constant of a Reflected Wave Returning from a Complex Z_L

Refer to the Front-Panel Operation Reference for performing this time interval measurement using the ΔV and ΔT markers.

Discontinuities on the Line

So far, mention has been made only about the effect of a mismatched load at the end of a transmission line. Often, however, one is not only concerned with what is happening at the load, but also at intermediate positions along the line. Consider the transmission system in figure C-9.

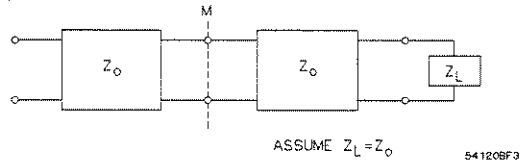

Figure C-9

The junction of the two lines (both of characteristic impedance Z_0) employs a connector of some sort. Let us assume that the connector adds a small inductor in series with the line. Analyzing this discontinuity on the line is not much different from analyzing a mismatched termination. In effect, one treats everything to the right of M in the figure as an equivalent impedance in series with the small inductor and then calls this series combination the effective load impedance for the system at the point M. Since the input impedance to the right of M is Z_0 , an equivalent representation is shown in figure C-10. The pattern on the oscilloscope is merely a special case of figure C-7A and is shown on figure C-11.

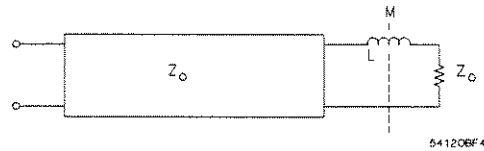

Figure C-10

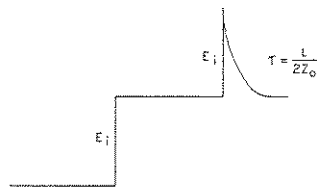

Figure C-11

Evaluating Cable Loss

Time domain reflectometry is also useful for comparing losses in transmission lines. Cables where series losses predominate reflect a voltage wave with an exponentially rising characteristic, while those in which shunt losses predominate reflect a voltage wave with an exponentially-decaying characteristic. This can be understood by looking at the input impedance of the lossy line.

Assuming that the lossy line is infinitely long, the input impedance is given by:

$$Z_{in} = Z_0 = \sqrt{\frac{R + j\omega L}{G + j\omega C}}$$

Treating first the case where series losses predominate, G is so small compared to ωC that it can be neglected:

$$Z_{in} = \sqrt{\frac{R + j\omega L}{j\omega C}} = \sqrt{\frac{L}{C}} \left(1 + \frac{R}{j\omega L}\right)^{\frac{1}{2}}$$

Recalling the approximation $(1 + x)^a \approx (1 + ax)$ for $x < 1$, Z_{in} can be approximated by:

$$Z_{in} \approx \sqrt{\frac{L}{C}} \left(1 + \frac{R}{j2\omega L}\right) \text{ WHEN } R < \omega L$$

Since the leading edge of the incident step is made up almost entirely of high frequency components, R is certainly less than ωL for $t = 0^+$. Therefore, the above approximation for the lossy line which looks like a simple series R-C network, is valid for a short time after $t = 0$. It turns out that this model is all that is necessary to determine the transmission line's loss.

In terms of an equivalent circuit valid at $t = 0^+$, the transmission line with series losses is shown in Figure C-12.

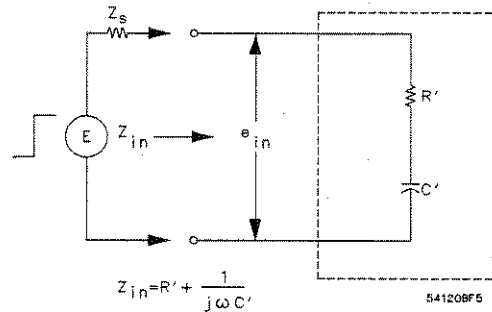

Figure C-12. A Simple Model Valid at $t = 0^+$ for a line with series losses

The response to a step of height E appears as figure C-13, where $Z_s =$ source impedance, and assumed resistive.

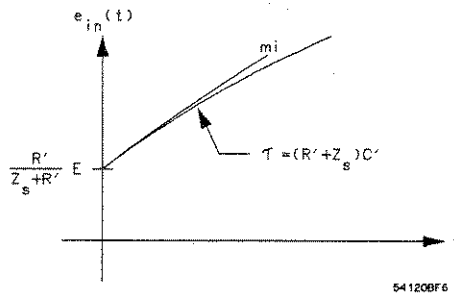

Figure C-13

In the case where $Z_s = R'$, and $\tau = 2Z_s C'$ and the initial slope of $e_{in}(t)$ is given by:

$$m_i = \frac{E}{4R' C'} = \frac{E}{8L} R$$

The series resistance of the lossy line (R) is a function of the skin depth of the conductor and therefore is not constant with frequency. As a result, it is difficult to relate the initial slope with an actual value of R . However, the magnitude of the slope is useful in comparing cables of different loss.

A similar analysis is possible for a cable where shunt losses predominate. Here the input admittance of the lossy cable is given by:

$$Y_{in} = \frac{1}{Z_{in}} = \sqrt{\frac{G + j\omega C}{R + j\omega L}} = \sqrt{\frac{G + j\omega C}{j\omega L}}$$

Since R is assumed small, re-writing this expression for Y_{in} :

$$Y_{in} = \sqrt{\frac{C}{L}} \left(1 + \frac{G}{j\omega C}\right)^{\frac{1}{2}}$$

Again approximating the polynomial under the square root sign:

$$Y_{in} \approx \sqrt{\frac{C}{L}} \left(1 + \frac{G}{j2\omega C}\right) \text{ WHEN } G < \omega C$$

Going to an equivalent circuit (figure C-14) valid at $t = 0^+$,

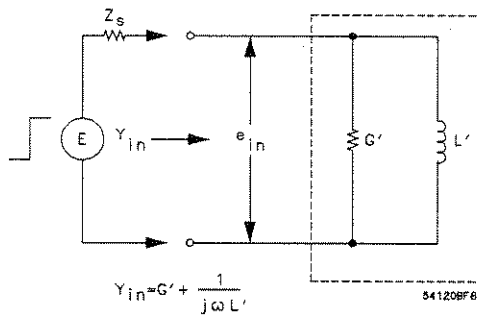

Figure C-14. A Simple Model Valid at $t = 0^+$ for a Line with Shunt Losses

$e_{in}(t)$ will look like figure C-15.

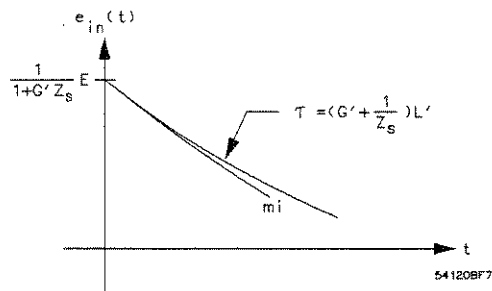

Figure C-15

Assuming $G' = \frac{1}{Z_s}$, $\tau = 2G'L'$ and the initial slope of $e_{in}(t)$ is given by:

$$m_i = -\frac{E}{4G'L'} = -\frac{E}{8C}G$$

Again G depends on frequency, but relative loss can be estimated from the value of m_i .

A qualitative interpretation of why $e_{in}(t)$ behaves as it does is quite simple in both these cases. For series losses, the line looks more and more like an open circuit as time goes on because the voltage wave traveling down the line accumulates more and more series resistance to force current through. In the case of shunt losses, the input eventually looks like a short circuit because the current traveling down the line sees more and more accumulated shunt conductance to develop voltage across.

Multiple Discontinuities

One of the advantages of TDR is its ability to handle cases involving more than one discontinuity. An example of this is figure C-16.

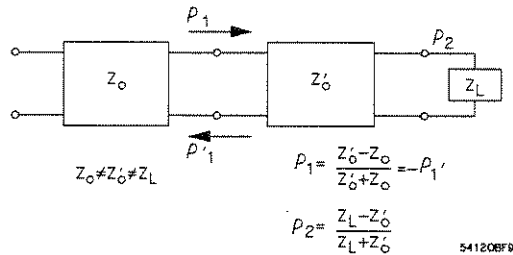

Figure C-16

The oscilloscope's display for this situation would be similar to the diagram in figure C-17 (drawn for the case where $Z_L > Z_0 > Z'_0$):

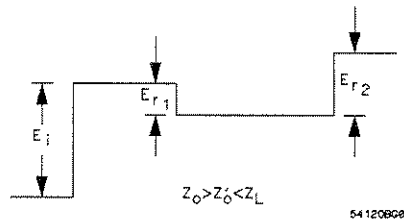

Figure C-17

It is seen that the two mismatches produce reflections that can be analyzed separately. The mismatch at the junction of the two transmission lines generates a reflected wave, E_{r1} , where

$$E_{r1} = \rho_1 E_i = \left(\frac{Z'_0 - Z_0}{Z'_0 + Z_0} \right) E_i$$

Similarly, the mismatch at the load also creates a reflection due to its reflection coefficient

$$\rho_2 = \frac{Z_L - Z'_0}{Z_L + Z'_0}$$

Two things must be considered before the apparent reflection from Z_L , as shown on the oscilloscope, is used to determine ρ_2 . First, the voltage step incident on Z_L is $(1 + \rho_1) E_i$, not merely E_i ; Second, the reflection from the load is

$$\left[\rho_2 (1 + \rho_1) E_i \right] = E_{rL}$$

but this is not equal to E_{r2} , since a re-reflection occurs at the mismatched junction of the two transmission lines. The wave that returns to the monitoring point is

$$E_{r2} = (1 + \rho'_1) E_{rL} = (1 + \rho'_1) \left[\rho_2 (1 + \rho_1) E_i \right]$$

Since $\rho'_1 = -\rho_1$, E_{r2} may be re-written as:

$$E_{r2} = \left[\rho_2 (1 - \rho_1^2) \right] E_i$$

The part of E_{rL} reflected from the junction of

$$Z'_0 \text{ AND } Z_0 \text{ (i.e., } \rho'_1 E_{rL} \text{)}$$

is again reflected off the load and heads back to the monitoring point only to be partially reflected at the junction of Z'_0 and Z_0 . This continues indefinitely, but after some time the magnitude of the reflections approaches zero.

Practical Handling of Multiple Discontinuities.

It is now seen that although TDR is useful when observing multiple discontinuities, one must be aware of the slight complication they introduce when analyzing the display. It is fortunate that most practical measuring situations involve only small mismatches (e.g., $Z_0 \approx Z'_0$) and the effect of multiple reflections is almost nil. Even in this situation, however, it is advisable to analyze and clean up a system from the generator end. The reflection from the first of any number of discontinuities is unaffected by the presence of others. Therefore if it is remedied first and one then moves on to the second discontinuity, the complications introduced by re-reflections will not exist.

Matching Source Impedance to Transmission Line Impedance

Until now nothing has been said concerning reflections that may have occurred at the generator end of the transmission line. In general, the source impedance of the step generator may not be equal to the characteristic impedance of the transmission line it drives. When this is the case, voltage waves returning from a mismatch or discontinuity in the system under test will be re-reflected at the generator end and will complicate the analysis of the display. Refer to figures C-18 and C-19. It is almost essential therefore, that the source impedance of the step generator matches the cable it drives. When this is the case, all re-reflections returning from the system under test pass the oscilloscope's monitoring point only once and are then absorbed in the source impedance of the step generator.

Figure C-18 is the oscilloscope display of a TDR system investigating a transmission line terminated into an open circuit. The source impedance of the step generator matches the characteristic impedance of the line under test ($Z_s = Z_o = 50 \Omega$).

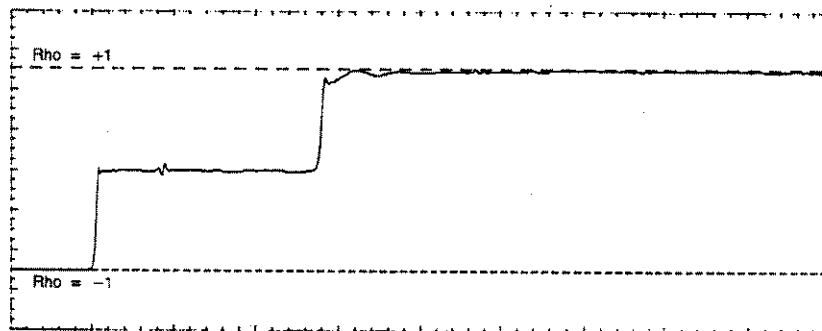

Figure C-18. A 50 Ω TDR System Testing a 50 Ω Line Terminated With an Open Circuit.

In figure C-19 this was not the case. Here the source impedance of the step generator is 50 Ω and the line impedance is 75 Ω . The jump from a 50 Ω to a 75 Ω cable is evident and follows TDR rules. But the step from the 75 Ω cable to the open circuit does not. Instead of jumping to a +1 reflection coefficient for an open circuit, the trace actually exceeds that value.

The 50 Ω to 75 Ω mis-match caused the reflected wave returning from the open circuit to be re-reflected at the source, thus launching a second incident wave down the line. This second wave travels back to the monitoring point. The second reflected wave, in turn, launches a third incident wave, down the line. This process continues indefinitely, but unless the reflection coefficient at each end is equal to ± 1 , the reflections decrease in magnitude and only the first few are noticeable.

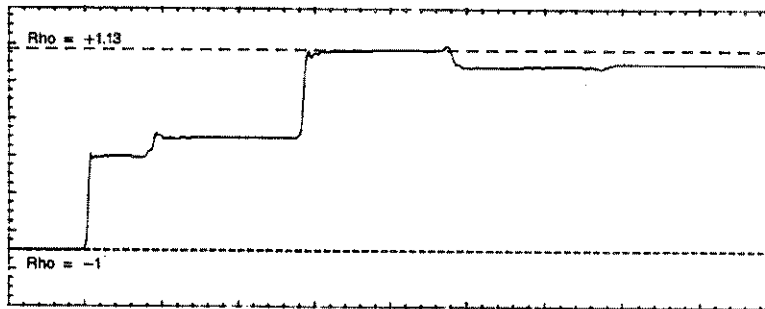

Figure C-19. A 50 Ω TDR System Testing a 75 Ω Line Terminated With an Open Circuit Yields a Display That is More Difficult to Interpret

Balun For measurements of transmission lines in the 200 Ω to 300 Ω region, a balun is the best solution. A good balun will permit a 200 Ω line to be tested without the danger of re-reflections from the 50 Ω source. A broadband balun should be used so that the incident step is not appreciably affected by sag or loss of risetime.

Matching L-Pad To completely eliminate the effect of multiple reflections in a non 50 Ω system, use a simple matching L-pad. Refer to figure C-20 and C-21.

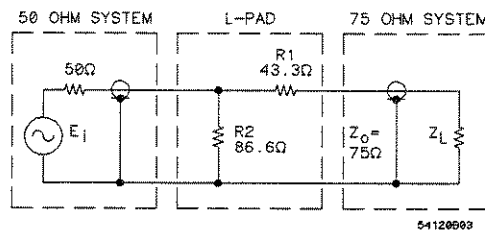

Figure C-20. L-Pad Matching 50 Ω Source to 75 Ω System Impedance

for $Z_0 > 50 \Omega$:
Resistance in series with

$$Z_0, R_1 = \sqrt{Z_0 (Z_0 - 50)}$$

Shunt resistance

$$R_2 = \sqrt{\frac{(50 Z_0)}{R_1}}$$

for $Z_0 < 50 \Omega$:
Resistance in series with source

$$R_1 = \sqrt{50 (50 - Z_0)}$$

Shunt resistance,

$$R_2 = \sqrt{\frac{(50 Z_0)}{R_1}}$$

The incident step and the reflections will be attenuated considerably. Refer to figure C-21. The sacrifice made to achieve the reflectionless connection is sensitivity, and a loss of calibration. It is a good rule of thumb to use the L-pad technique when major discontinuities are to be encountered and a tapered section when small discontinuities are present (such as in cable testing).

The $\pm 100\%$ reflection points may be determined with the voltage markers and by using a short and open at the transmission line's end.

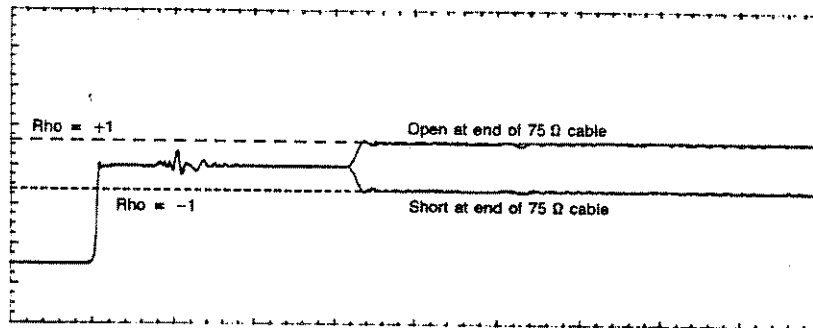

Figure C-21. A 50 Ω TDR System With a Matching L-Pad to the 75 Ω cable. The Amplitude Corresponding to $Rho = \pm 1$ is Reduced Using the Matching L-Pad

Instrument Configuration

In the preceding sections little consideration was given to the effects of the configuration of the oscilloscope and step generator on the measurement. Now let's examine this important part of the TDR measurement.

There are several different architectures for accomplishing TDR measurement. They are:

1. Terminated step generator and through-line sampler.
2. Terminated sampler and through-line step generator.
3. Terminated sampler, terminated step generator, and power splitter.

Traditionally, TDR systems have used the terminated step generator and through-line sampler architecture shown in figure C-22

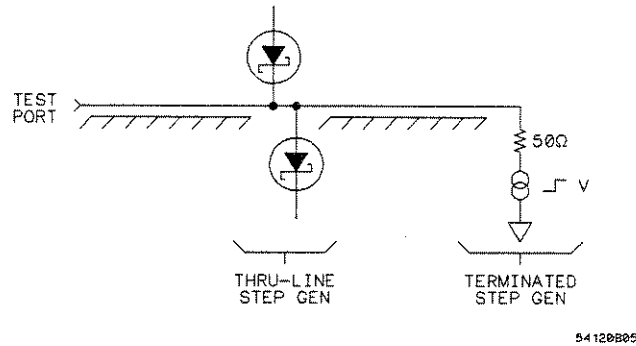

Figure C-22

The step generator was implemented using a tunnel diode. Because a tunnel diode is a low impedance device, it lends itself to a terminated configuration. The major drawback of this architecture is that small reflections from the terminated step generator are measured directly by the through-line sampler.

In the HP 54120 Series TDR systems, the terminated sampler and through-line step generator architecture in figure C-23 is used. In this case step generation is accomplished using a switched current source driven from a step recovery diode. This configuration is advantageous because small reflections from the terminated sampler propagate back to the through-line step generator where only a small portion of the already small reflection is sent back to the terminated sampler and measured. None of the reflections from the step generator or the sampler are measured directly, thus improving the system performance.

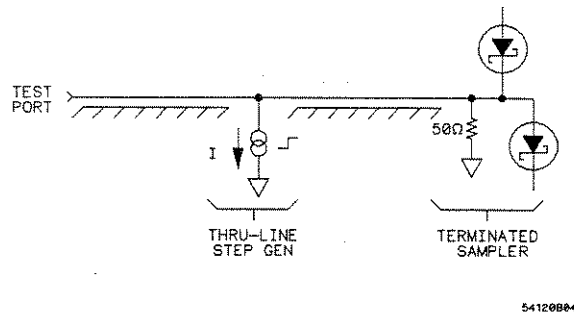

Figure C-23

The terminated sampler, terminated step generator, and power splitter architecture in figure C-24 is useable but is typically not used because both the incident and reflected step are attenuated when they pass through the power splitter. This decreases the system signal-to-noise ratio.

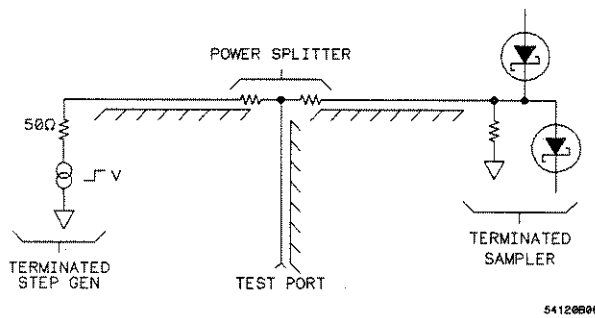

Figure C-24

Risetime and Distance Resolution

The examples shown so far have assumed that the TDR step has zero risetime. Practical TDR systems have a finite risetime for both the step generator and the sampler. The effect of the finite risetime of the TDR system is to low-pass filter the ideal (zero risetime) response of a given discontinuity with a filter that has a risetime equal to the combined risetime of the step generator and sampler which is approximated by:

$$t_{r \text{ system}} \approx \sqrt{(t_{r \text{ step gen}})^2 + (t_{r \text{ sampler}})^2 + (\text{test setup})^2}$$

The distance or time resolution of a TDNA system is related to the system risetime. The distance to a discontinuity is given by:

$$d = vt \text{ SO THAT } d = \frac{c}{\sqrt{\epsilon_r}} \frac{t_o}{2}$$

where c is the speed of light, t_o is the Delta time between the incident step and the reflected signal, and ϵ_r is the relative dielectric constant of the dielectric of the transmission line. Therefore the distance that separates two discontinuities is given by:

$$\Delta d = \frac{c}{\sqrt{\epsilon_r}} \frac{t_2 - t_1}{2}$$

where t_1 is the two way travel time to one discontinuity and t_2 is the two way travel time to second discontinuity. These two discontinuities become indistinguishable when separated by a time $(t_2 - t_1)$ of less than half the system risetime. Therefore the minimum distinguishable distance between two discontinuities is given by:

$$d_{\min} = \frac{c}{\sqrt{\epsilon_r}} \frac{t_r}{4}$$

This means that with the HP 54120 Series TDR system risetime of 45 ps, two discontinuities merge together and become indistinguishable at 3.5 mm for an air dielectric. For practical systems the HP 54120 Series TDR systems define the distance resolution to be twice this number, or 7 mm in air.

An example of how risetime affects distance resolution is an airline with two washers (capacitive discontinuities) placed 2 mm apart on the center conductor. The risetime needed to distinguish these as separate discontinuities is given by:

$$d_{\min} = \frac{c}{\sqrt{E_r}} \frac{t_r}{4} \quad \text{OR} \quad t_r = \frac{4d_{\min} \sqrt{E_r}}{c} = 26.7 \text{ ps}$$

The results of a TDR measurement, using normalization to decrease the system risetime, on this airline at three different risetimes (40, 26, and 10 ps) is shown in Figure C-25. At 40 ps it is not possible to distinguish each discontinuity. At 26 ps the separate discontinuities begin to show. Finally, at 10 ps risetime both discontinuities are clearly discernible.

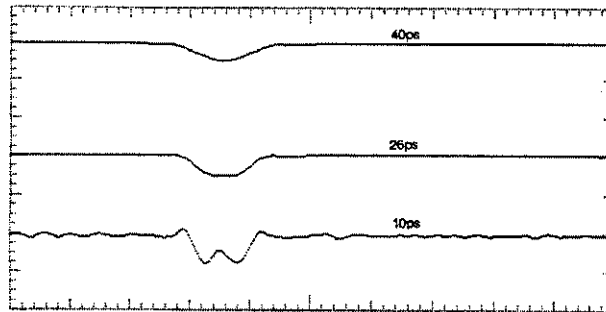

Figure C-25. Two Discontinuities 2 mm Apart can be Distinguished with a System Risetime of 10 ps

Small L's and C's

Figure C-26 is an example of risetime effects for a series L discontinuity in a 50 Ω line. If the combined step generator and sampler risetime, $t_{r \text{ system}}$, is much less than the risetime of the low-pass filter, $t_{r \text{ lpf}}$, created by the discontinuity (where $t_{r \text{ lpf}} \sim 2.2 \times T$ where $T = L \div 100 \Omega$), the result approaches the ideal as shown in figure C-26 Plot A.

If $t_{r \text{ system}} \sim t_{r \text{ lpf}}$, the result is as shown in Figure C-26 Plot C.

If $t_{r \text{ system}} > t_{r \text{ lpf}}$, the result is as shown in Figure C-26 Plot D.

Plot A: $t_{r \text{ lpf}} = 100 \times t_{r \text{ system}} = \text{approaches ideal}$

Plot B: $t_{r \text{ lpf}} = 10 \times t_{r \text{ system}}$

Plot C: $t_{r \text{ lpf}} = t_{r \text{ system}}$

Plot D: $t_{r \text{ lpf}} = 1/10 \times t_{r \text{ system}}$

$t_{r \text{ system}} =$ Combined risetime of the step generator and sampler.

$t_{r \text{ lpf}} =$ Risetime of the low pass filter created by the discontinuity.

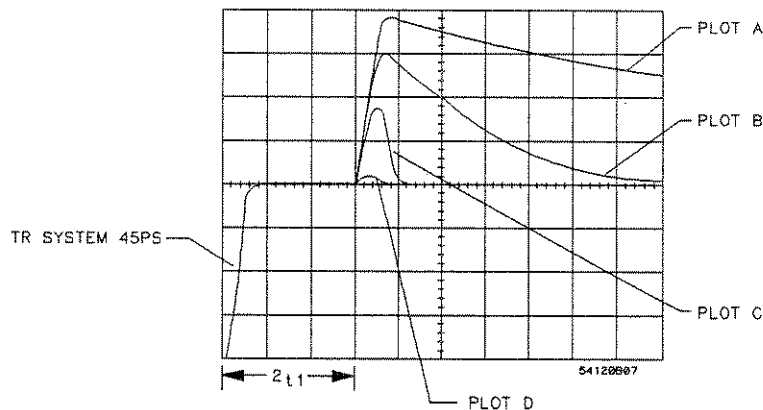

Figure C-26. System Risetime Affects the TDR Results

In analyzing TDR results so far, we have assumed that the time constant and therefore risetime ($t_{r\text{ ipf}}$) created by a discontinuity were known and therefore the value of the inductor L or capacitor C was also known. In most TDNA measurements, only the combined step generator and sampler risetime ($t_{r\text{ system}}$) and the reflected waveform are known. From this information, you may want to derive the value of the discontinuity L or C. Again three cases exist in this analysis. If $t_{r\text{ system}} < t_{r\text{ ipf}}$, then, as stated earlier, the TDR response approaches the ideal result and a value for the L or C can be calculated (as in figure C-7) from the measured time constant of the exponential decay or rise to the final value. If $t_{r\text{ system}}$ is of the same order of magnitude as $t_{r\text{ ipf}}$, then calculating the L or C discontinuity becomes much more difficult due to the interaction of the time constants.

One way to find the value of the L or C in this case is to use a SPICE simulation program to model the response and vary the L or C value until the maximum reflection on the SPICE simulation program and the TDR waveform match. Accuracy depends on using realistic waveforms in the SPICE simulation. When $t_{r\text{ system}} > t_{r\text{ ipf}}$ (i.e. small reflections), it is possible to relate the reflected signal to the value of the L or C by assuming the L or C is driven by a current or voltage source. This is equivalent to saying that for the frequencies contained in the step, the impedance of a discontinuity does not significantly alter the impedance of the circuit loading it. Using this approximation, we can relate the maximum slope of the step to the maximum reflection from the discontinuity. If the TDNA step is Gaussian (or can be normalized to an approximately Gaussian step), then it can be shown that the maximum slope of the step is 27% higher than the slope of a line through the 10% and 90% risetime points. For reflections less than 10%, the error resulting from this method is less than 3%, not including measurement error of the TDR system.

For a series inductive discontinuity, the relationship between the reflected signal and the inductor, L, is found as follows:

1. Since $\omega L \ll 100 \Omega$ for frequencies of interest

$i_L \sim v_{\text{step}} / 100 \Omega$ where i_L is the current through L and v_{step} is the open circuit step amplitude

2. The voltage across the inductor therefore is

$v_L = L d(i_L) / dt = (L/100) \times d(v_{\text{step}}) / dt$ where v_L is the voltage across the inductor, and $v_{L\text{max}} = (L / 100) \times (d(v_{\text{step}}) / dt) \text{max}$

3. As discussed above the max slope is

$(d\text{step} / dt) \text{max} = (0.8) (v_{\text{step}}) (1.27) / t_{rL} = 1.016 v_{\text{step}} / t_{rL}$

4. If the incident voltage at the inductor is v_{iL} and the reflected voltage at the inductor is v_{rL} then

$v_{iL} = 0.5 v_{\text{step}}$ or $v_{\text{step}} = 2v_{iL}$
and
 $v_{rL} = 0.5 v_L$ or $v_L = 2 v_{rL}$

5. Combining 2, 3, and 4 above produces

$(v_L) \text{max} = (L / 100) (d(v_{\text{step}} / dt) \text{max})$
 $(v_L) \text{max} = (L / 100) 1.016 v_{\text{step}} / t_{rL}$

$2(v_{rL}) \text{max} = (L / 100) (1.016) 2 (v_{iL}) / t_{rL}$
 $L - (100) (v_{rL}) (t_{rL}) / (1.016 v_{iL})$

Since $\rho = v_{rL} / v_{iL}$ then

$L = 98.4 \rho t_{r \text{ system}}$ For a series L discontinuity
 $\pm 3\%$ when $\rho \leq 10\%$

Using a similar derivation for a shunt C interline discontinuity, the relationship between shunt C and the reflection is:

$C = 0.0303 \rho t_{rL}$ For a shunt C discontinuity
 $\pm 3\%$ when $\rho \leq 10\%$

Cable Loss

As a step travels down a non-ideal transmission line, the higher frequencies are attenuated by skin effect losses and dielectric losses. This distorts the step, and is called cable loss. The effect of cable loss is shown in Figure C-27 Plot A, which shows the reflection of a short at the end of a 1 meter cable. Since cable loss degrades the risetime of the TDR step, it can limit the distance resolution and the accuracy of reflection measurements made at the end of a cable.

If fast risetime TDR measurements are needed, short interconnecting cables should be used to reduce the effects of cable loss. The same reflection off a short is shown in Figure C-27 Plot B except now it is at the end of a very short cable (approximately 5 cm).

Another way to reduce cable loss effects is to use normalization, if the TDR system has this capability. Normalization to an ideal (approximating a Gaussian) step removes the effects of cable loss to the point in the cable where a calibration is done which establishes the reference plane from which TDR measurements can be made without suffering effects from the cable. Calibration typically involves connecting a $50\ \Omega$ termination and a short termination at the reference plane. Figure C-27 Plot C shows the results of normalizing the reflection of a short at the end of a 1 meter cable. Normalization can also be used to remove cable loss effects from transmission measurements.

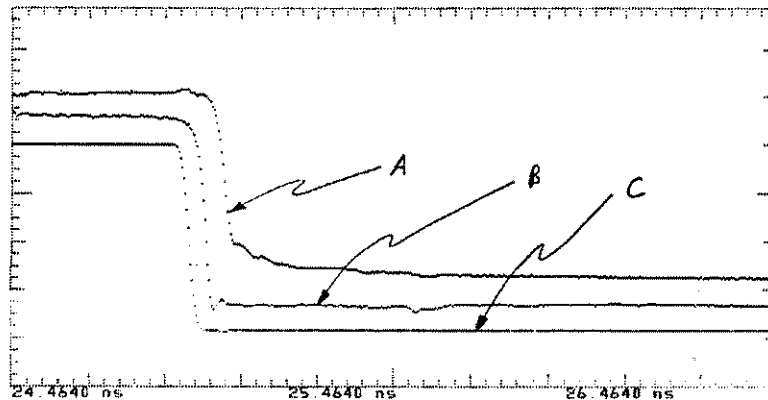

Figure C-27. Short Cables (B) and Normalization (C) can Reduce the Effects of Cable Loss Seen in (A)

Multiple Discontinuities

Multiple discontinuities are another source of error in TDR measurements. A discontinuity that occurs before the discontinuity of interest will cause a degradation of risetime and accuracy of reflection measurements similar to cable losses. Typically in a TDR system, if high accuracy and resolution are needed to examine a particular discontinuity on a transmission line, the reflections due to discontinuities that are before the one of interest must be small. One example involves a transmission line with two discontinuities on it. The first one has a maximum reflection coefficient of ρ_1 and the second of ρ_2 . The percent error in ρ_2 due to ρ_1 is:

$\rho_1\%$	error in ρ_2
0.01	< 0.25%
0.05	~ 2%
0.10	~ 6%

These results are computed values and are useful for estimating errors in measurements. As with cable loss, you can remove the effects of multiple discontinuities using normalization up to the point in the transmission line where a calibration is done.

Using TDR to Test Interconnects

One of the largest applications of TDR measurements is optimizing and testing transmission line systems. An example of this involves the interface from a PC board 50 Ω line to a thickfilm hybrid 50 Ω line. If the connection was made with a 3 mm wire bond, then this would introduce a series inductive discontinuity into the line. Where L_{wb} is the inductance of the wire bond. Refer to figure C-28. A wire bond in free space would have an inductance of about 1.26 nH/mm but since it is located near the ground planes of the transmission lines the inductance is somewhat lower. A measured inductance for typical wire bonds on hybrids is about 1 nH/mm. If we assume this number, then the inductance of the 3 mm wire bond is 3 nH. This then says that the low-pass filter created by L_{wb} in the 50 Ω line has a risetime given by:

$$t_r = 2.2 T$$

$$\text{where } T = \text{time constant} = L_{wb} / 100 \Omega$$

$$2.2 \times 3 \text{ nH} / 100 \Omega = 66 \text{ ps}$$

Therefore the risetime of the signal that is to pass through this discontinuity should be greater than 66 ps if it is not to be significantly degraded. If the signal to be transmitted through the discontinuity was a 350 ps risetime logic signal, then the risetime degradation would be small. Even though the risetime degradation is small there will be a significant reflection off the wire bond. Assuming the reflection is less than 10%, then an equation predicts a maximum reflection of:

$$L = 98.4 \rho t_{r \text{ system}}$$

$$\text{or } \rho = L / (98.4 t_{r \text{ system}}) = 3 \text{ nH} / ((98.4) (350 \text{ ps})) = 8.7\%$$

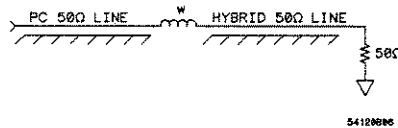

if the edge was an ideal Gaussian step.

Figure C-28

If the step is not ideal, this gives an approximate answer. This reflection may or may not be a problem. If the circuit driving the 50 Ω line is source-terminated in 50 Ω then this will not be a problem, but if it is driven from a current, source such as an open collector of a transistor, then it could. If it is desired to minimize reflections of this discontinuity, then there are methods to do this. Refer to figure C-28. If a TDR system is used to measure the transmission line, a response would be seen as shown in figure C-30 which is an inductive response with a max reflection of about 8.7% as predicted before. If the capacitance along the wire bond could be increased, this would reduce the maximum reflection since the wire bond section is moving towards a 50 Ω line. While it may not be possible to do this, it is possible to increase the capacitance at the two ends of the wire bond by widening the 50 Ω lines there. The circuit would now resemble the circuit shown in Figure C-29. When the value of C1 and C2 are chosen properly, the TDR response of the system would now be as shown in Figure C-31. The value of C1 and C2 which minimizes the maximum reflection is 0.6 pF which can be calculated from the equation.

$$Z_0 = 50 \Omega = L/C \text{ where } C = C1 + C2$$

$$\text{therefore } C1 = C2 = L / (Z_0)^2 \text{ or } C1 = C2 = 0.6 \text{ pF}$$

The resultant circuit is actually a third order Butterworth filter. Refer to figure C-31. The bandwidth of the resultant Butterworth filter has the same bandwidth as the initial single pole filter. Since the risetime of the step to be transmitted is much greater than the risetime of either the single pole or Butterworth filter there will be little effect on the transmitted step.

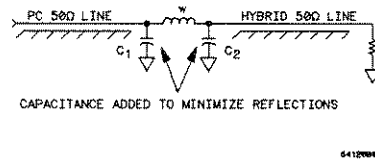

Figure C-29

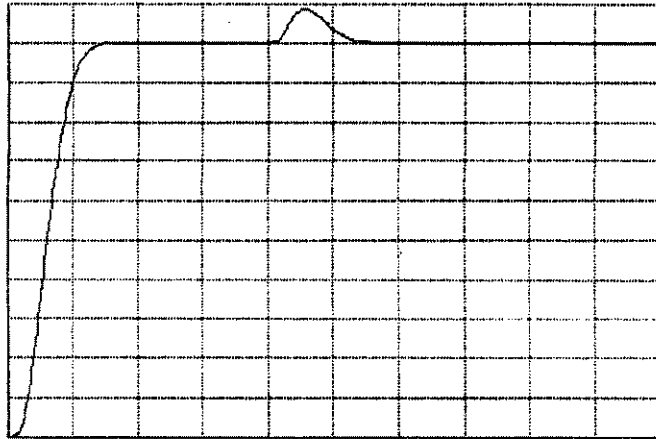

Figure C-30. Inductance of the Wirebond Causes a Reflection

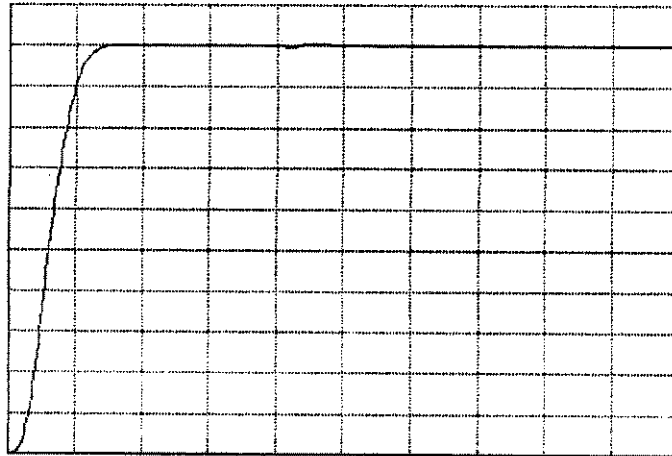
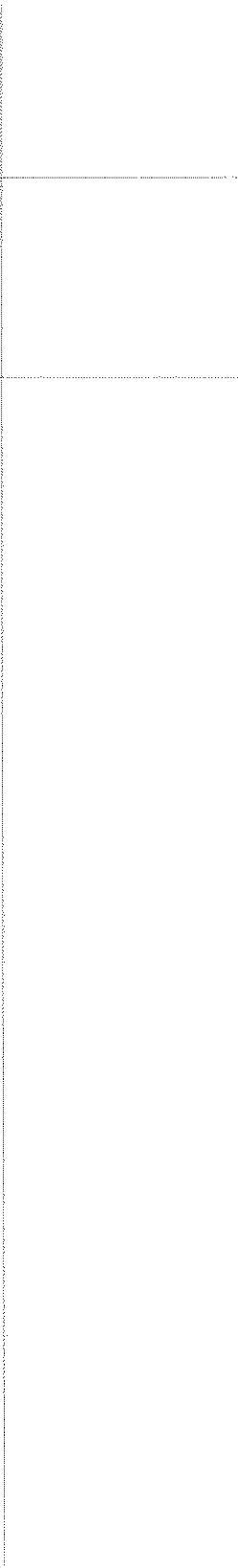
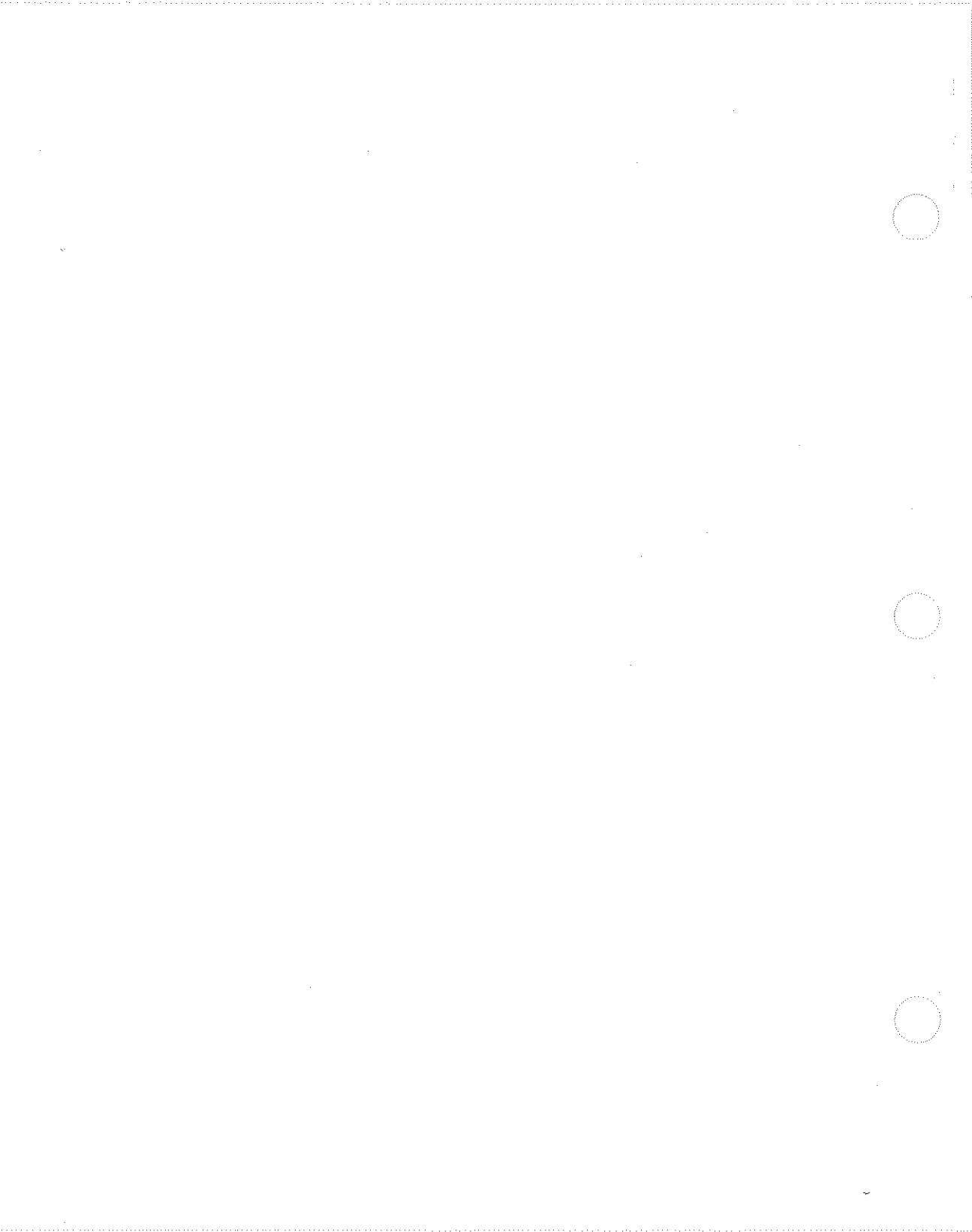

Figure C-31. Extra Capacitance can Compensate for the Wirebond's Inductance, Reducing the Reflection



Improving Time Domain Network Analysis Measurements

D

Time Domain Network Analysis and Normalization*

Normalization, an error-correction process, helps ensure that time domain network analysis measurements are as accurate as possible. The HP 54120 Series digitizing oscilloscopes with TDR capability include normalization as a standard feature. With normalization software built into the oscilloscope, external controllers and multiple step generators or risetime converters are not needed. Normalization not only enhances measurement accuracy, it simplifies the measurement process.

Time domain network analysis (TDNA), includes both time domain reflectometry (TDR) and time domain transmission (TDT) measurements. TDNA measurement accuracies can be improved using normalization techniques. This appendix discusses normalization and assumes the reader is familiar with basic TDNA measurements. For background on TDNA measurements, refer to the "HP 54120 Series Digitizing Oscilloscope Getting Started Guide."

Time domain reflectometry (TDR) sends a very fast edge down a transmission line to a test device and then measures the reflections from that device. The measured reflections often make short work of designing signal path interconnects and transmission lines in IC packages, PC board traces, and coaxial connectors.

Time domain transmission (TDT) measurements are made by passing an edge through the test device. Parameters typically measured are gain and propagation delay. Transmission measurements also characterize crosstalk between traces.

Imperfect connectors, cabling, and even the response of the oscilloscope itself can introduce errors into TDNA measurements. Understanding the effects of these errors, and more importantly, how to remove them, will result in more accurate and useful measurements.

Normalization can be used in TDNA to remove the oscilloscope response, step aberrations, and cable losses and reflections so that the only response measured is that of the device under test (DUT). In addition, normalization can be used to predict how the DUT would respond to an ideal step of any arbitrary risetime.

* Normalization in the HP 54120 Series test sets with TDR capability utilize the Bracewell transform, which is under license from Stanford University.

Sources of Measurement Error

Cables and Connectors Cause Losses and Reflections

There are three primary sources of error in TDNA measurements: the cables and connectors, the oscilloscope, and the step generator.

Cables and connectors between the step source, the DUT, and the oscilloscope can significantly affect measurement results. Impedance mismatches and imperfect connectors add reflections to the actual signal being measured. These can distort the signal and make it difficult to determine which reflections are from the DUT and which are from other sources.

In addition, cables are imperfect conductors that become more imperfect as frequency increases. Cable losses, which increase at higher frequencies, increase the risetime of edges and cause the edges to droop as they approach their final value.

Figure D-1 illustrates how cables and connectors affect TDNA measurements. The upper waveform is the reflection of a step from a short circuit. Connections cause the reflections at the peak of the step and along the baseline. Cable loss yields the rounded transition of the step to its baseline level. Normalization can correct the measured data, resulting in the lower waveform.

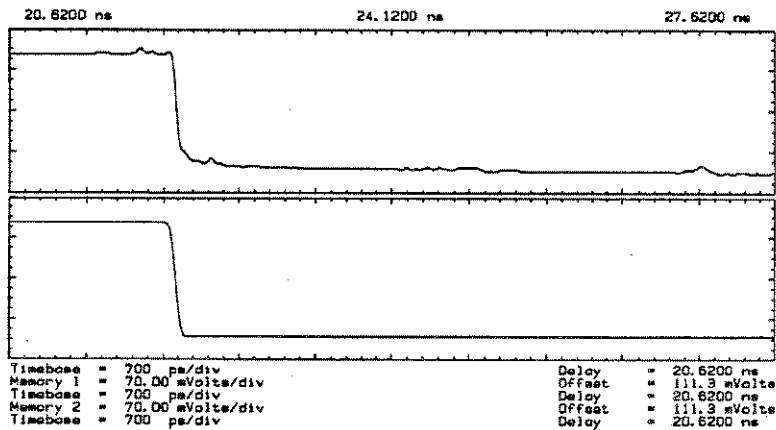

Figure D-1. The top waveform shows distortions caused by cables and connectors. The bottom waveform shows how normalization corrects for these distortions

The Oscilloscope as an Error Source

Oscilloscopes introduce errors into measurements in several ways. The finite bandwidth of the oscilloscope translates to limited risetime. Edges with risetimes less than the minimum risetime of the oscilloscope are measured slower than they actually are. When measuring how a device responds to a very fast edge, the oscilloscope's limited risetime may distort or hide some of the device response.

The oscilloscope can also introduce small errors that are due to the trigger coupling into the channels and channel crosstalk. These errors appear as ringing and other non-flatness in the display of the measurement channel baseline and are superimposed on the measured waveform. They are generally small and so are only significant when measuring small signals.

The Step Generator as an Error Source

The shape of the step stimulus is also important for accurate TDNA measurements. The DUT responds not only to the step, but also to the aberrations on the step such as overshoot and non-flatness. If the overshoot is substantial, the DUT's response can be more difficult to interpret.

The risetime of the step is also extremely important. In most cases the step generator used for TDNA will have a fixed risetime. A hardware filter known as a risetime convertor can be used in some systems to change the risetime.

To determine how the DUT will actually respond, you should test it at edge speeds similar to those it will actually encounter. Consider the example of a BNC connector (figure D-2). Only about 3% of a 350 ps risetime edge (top waveform) is reflected by a BNC connector whereas 6% of a 100 ps risetime edge (middle waveform) is reflected and about 8% of a 50 ps risetime edge (bottom waveform) is reflected.

In the case of this measurement, the results obtained using a 50 ps risetime step stimulus do not apply for a connector that sees edges that are always slower than 350 ps. The connector might be acceptable for 350 ps edges but not for 50 ps edges. Measurements made at inappropriate risetimes can yield invalid conclusions.

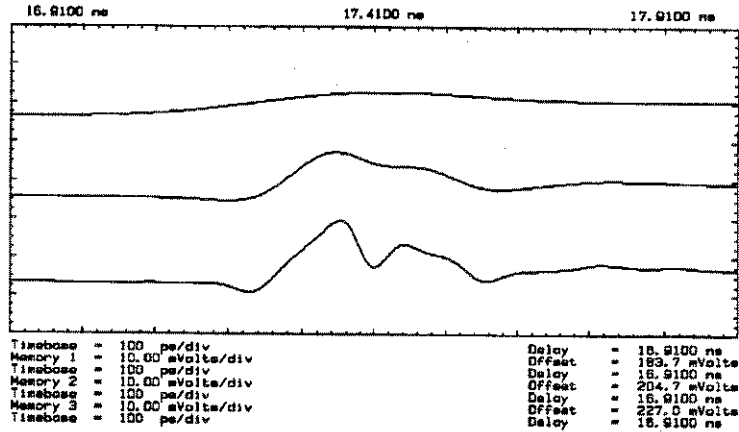

Figure D-2. Variable edge speed helps determine the amount of reflection in actual applications. The top waveform (tested to 350 ps) shows less reflection than the middle waveform (tested to 100 ps) or the bottom waveform (tested to 50 ps)

Edge speed is also critical when using TDR to locate the source of a discontinuity along a transmission line. Just as the limited risetime of the oscilloscope can limit the accuracy of this kind of measurement, the risetime of the step source can also limit accuracy.

The risetime of the measurement system is limited by the combined risetimes of the oscilloscope and the step generator. It can be approximated by equation 1.

Equation 1

$$\text{System risetime} = \sqrt{(\text{Step risetime})^2 + (\text{Scope risetime})^2 + (\text{Test setup-up risetime})^2}$$

In a system with zero minimum risetime, the response of a discontinuity would not be attenuated at all. A real system has a limited risetime, which acts as a lowpass filter. If the step stimulus used is too slow, the true nature of the discontinuity may be disguised or may not even be visible. The cause may be more difficult to physically locate. Notice in figure D-2 that as the risetime of the step stimulus is decreased, the true nature of the reflection from the DUT becomes more apparent.

Removing Measurement Errors

Waveform Subtraction has Limitations

In the past, waveform subtraction was used to reduce the effects of some of the errors discussed above. It was convenient because many digitizing oscilloscopes provided this feature without the aid of an external controller. A known good reference device was measured and the reference waveform stored in memory. The reference waveform could then be subtracted from the waveform measured from the DUT. The result showed how the DUT response differed from the reference response. This technique removed error terms common to both the reference and DUT waveforms, such as trigger coupling, channel crosstalk, and reflections from cables and connectors.

Waveform subtraction has, however, several shortcomings. First, it requires that a known good reference DUT exists and is available to measure. In some cases a good DUT may not be readily available or may not exist at all. Second, the waveform which results from the subtraction process is a description of how the DUT response differs from the reference response. Hence, there is no way to view the actual DUT response without the errors introduced by the test system.

Finally, the most significant shortcoming is that measurements are limited to the risetime of the test system. Determining the DUT response at multiple risetimes is cumbersome. Either multiple step generators or multiple risetime convertors are necessary and a separate reference waveform is required for each risetime.

Normalization Improves on Error Correction

A digital error-correction method known as normalization can significantly reduce or remove all of the above types of errors from TDNA measurements. Taking full advantage of its powerful internal microprocessor, the HP 54120 Series digitizing oscilloscopes with TDR capability include normalization as a standard feature.

Normalization can predict how the DUT will respond to an ideal step of the user-specified risetime. Only one step generator and one calibration process are required. No risetime convertors are necessary, and the calibration standards are not related to the DUT.

**Examples of What
Normalization Can
Do**

Unlike a risetime converter, normalization can also increase the bandwidth (i.e., decrease the risetime) of the system by some amount depending on the noise floor. This means that when more bandwidth is critical, such as when trying to locate a discontinuity along a transmission line, the waveform data acquired by the oscilloscope can be "squeezed" for every bit of useful information it contains.

The following two examples illustrate what normalization can accomplish:

Example 1: Correcting for the TDR measurement errors introduced by connecting hardware.

Consider trying to model a device at the end of some imperfect test fixture as in figure D-3.

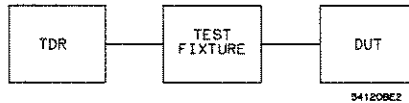

Figure D-3. Test system with the device at the end of an imperfect test fixture

This example uses two identical printed circuit boards (PCBs) to model this measurement. The PCBs have a $50\ \Omega$ trace on them with two discontinuities. The first PCB represents the test fixture, and the second PCB represents the DUT. The goal is to accurately measure the reflections caused by the DUT (second PCB). Figure D-4 is the unnormalized response of the system.

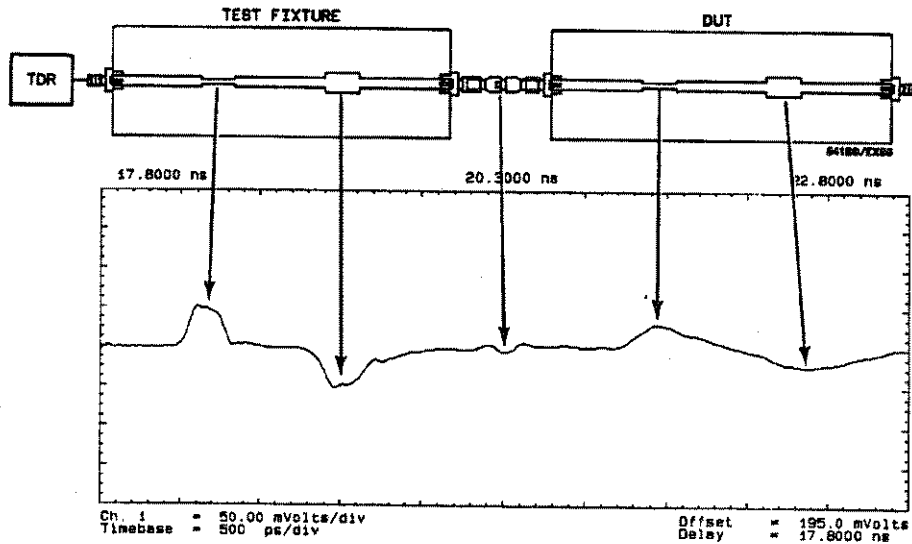

Figure D-4. In an unnormalized measurement, the reflections from the DUT are masked by the imperfect test fixture

The TDR response shows the reflections of the second PCB to be different from the first PCB. TDR accurately measures the first discontinuity. But TDR measures each succeeding discontinuity with less accuracy, as the transmitted step degrades and multiple reflections occur. Thus the two identical boards show different responses.

By defining a reference plane to be at the end of the test fixture (first PCB) and then normalizing, the errors can be corrected.

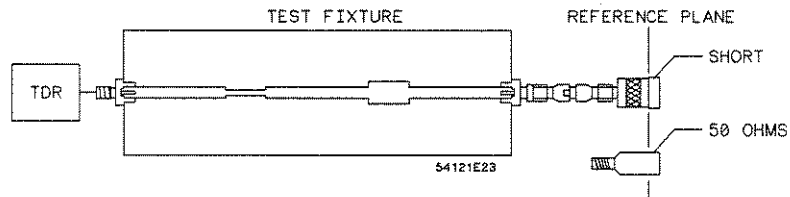

Figure D-5. A normalization calibration uses first a short, then a 50 Ω termination to define a reference plane and generate a digital filter

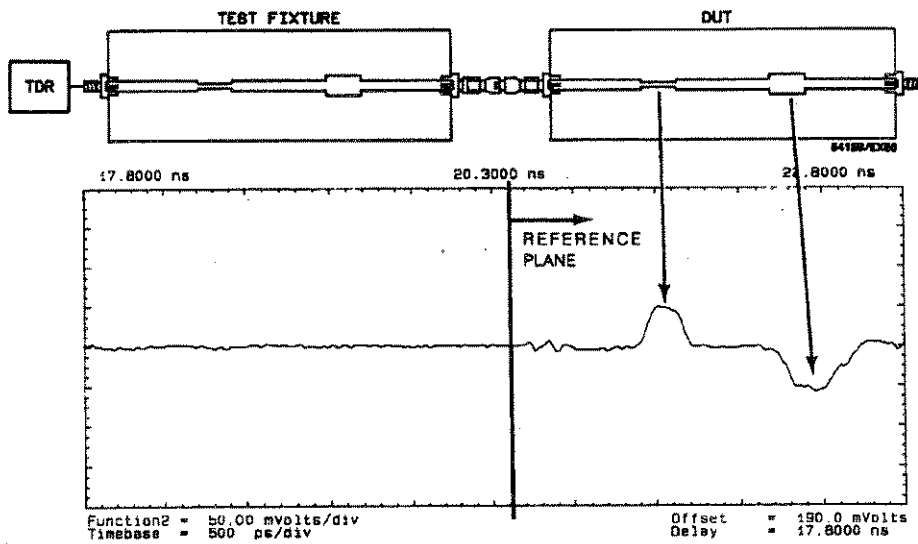

Figure D-6. The normalized measurement corrects for the errors introduced by test fixture.

Calibration first defines a reference plane and generates a digital filter. The normalizing measurement then corrects for the errors introduced by the test fixture. Notice how the normalized response of the second PCB (DUT) now matches the response measured earlier of the nearly identical first PCB.

To further verify the accuracy of the normalization, the response of the second PCB is measured without the first PCB.

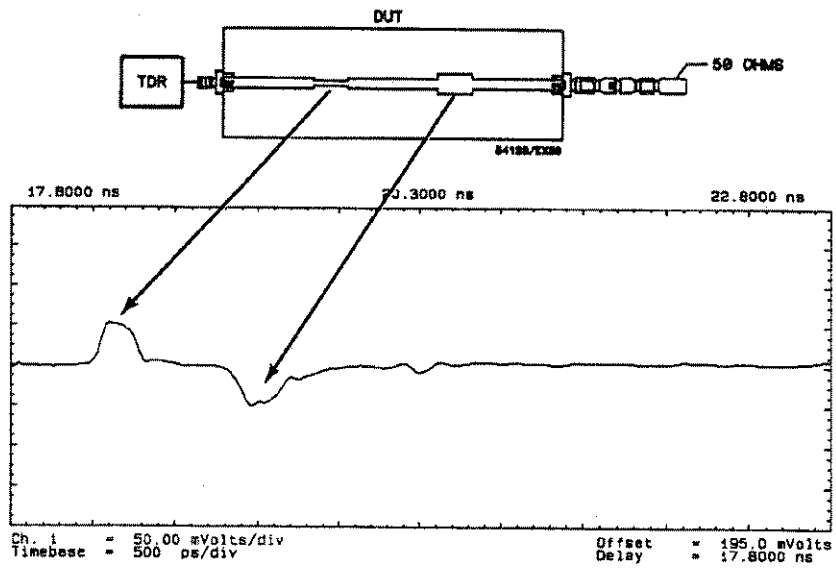

Figure D-7. The unnormalized response of the DUT, measured without the test fixture

Example 2: Resolving two discontinuities separated by 2 mm.

Normalization can improve the TDR's ability to resolve adjacent discontinuities. Figure D-8 shows the TDR measurement results of two capacitive discontinuities 2 mm apart in an air dielectric. Note that at a system risetime slower than 45 ps, the two discontinuities appear to be one. By normalizing the response to a system risetime of 10 ps, both discontinuities can be seen.

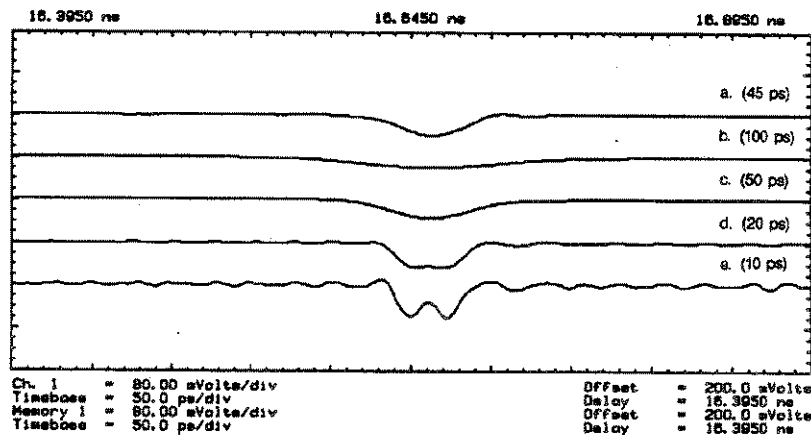

Figure D-8. Normalization improves the ability to distinguish two discontinuities by decreasing the system risetime.

- a. System risetime = 45 ps
- b. System risetime = 100 ps
- c. System risetime = 50 ps
- d. System risetime = 20 ps
- e. System risetime = 10 ps

Calibration Characterizes the Test System

Calibration makes the normalization process possible. Calibration measurements, which characterize the test system, are made with all cables and connections in place but without the DUT.

TDNA accomplished with a step generator and an oscilloscope is called step TDNA. TDNA accomplished with a frequency-domain network analyzer and a swept sinewave source is called CW TDNA. Normalization may be applied in either case. However, the calibration process for CW TDNA requires three measurements whereas only two are required for step TDNA.

Removing Systematic Errors

The first part of TDNA calibration removes systematic errors due to trigger coupling, channel crosstalk, and reflections from cables and connectors.

For TDR, this is done by replacing the DUT with a termination having an impedance equal to the characteristic impedance of the transmission line. If the termination is properly matched, all of the energy that reaches it will be absorbed. The only reflections measured result from discontinuities along the transmission line.

For TDT, this calibration step is done with nothing connected to the oscilloscope input.

In both cases, the measured waveforms are stored and subtracted directly from the measured DUT response before the response is filtered. Ideally, these calibration waveforms are flat lines. Any non-flatness or ringing is superimposed on the measured DUT response and represents a potential measurement error source. These errors are not related to the magnitude of the response of the DUT. Therefore, it is valid to subtract them directly. Notice in figure D-9 that the errors present in the TDR calibration waveform (bottom) are also visible in the measured DUT waveform (top), particularly at the left side of the figure.

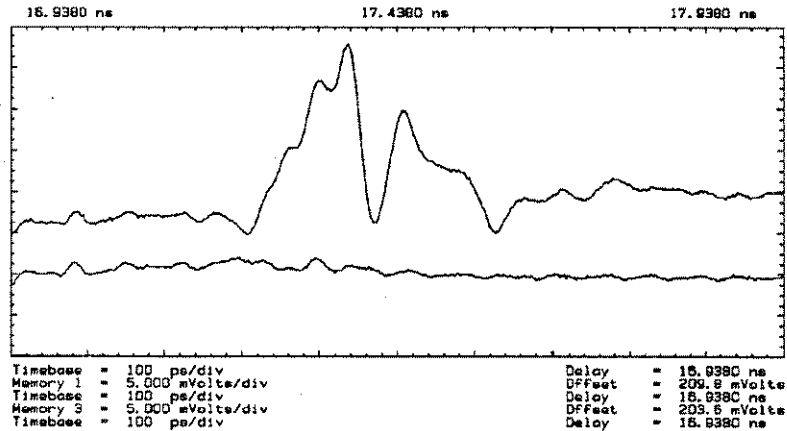

Figure D-9. Errors present in the TDR calibration waveform (bottom) are visible in the measured waveform (top)

Generating the Digital Filter

The second part of the calibration generates the digital filter. Unlike the errors removed by subtracting the first calibration signal, the errors removed by the filter are proportional to the amplitude of the DUT response.

For the second part of the TDR calibration, the DUT is replaced by a short circuit. The frequency response of the test system is derived from the measured short cal signal. Note that a short circuit should be used rather than an open circuit. When a step hits an open circuit at the end of a real-world transmission line, some of the energy is lost due to radiation rather than being reflected. Of course there is no such thing as a perfect short either, but the energy lost due to resistance in the short has a much smaller effect.

It is important that a good quality short be used, because the calibration process assumes a perfect short circuit termination. Any non-ideal components in the measured short cal signal are attributed to the test system. If any of the non-ideal components are, in reality due to the short itself, the filter will attempt to correct for error terms which do not exist in the test system. By attempting to correct for errors which do not exist, the filter can actually add error terms into the normalized measurement results.

In the second part of the TDT calibration, the transmission through-path is connected without the DUT. The frequency response of the test system is then measured with the aid of the step stimulus. With this information, a digital filter can be computed that will compensate for errors due to anomalies in the frequency response of the test system.

Correcting for Secondary Reflections

Secondary reflections caused by the impedance mismatch between the test port and the transmission media can also be corrected. In step TDNA, airlines can separate the primary reflection from the secondary reflection. Time windowing can then be used to remove the secondary reflection. In CW TDNA, a third calibration is used.

The impedance mismatch between test port and transmission media reflects a portion of the primary reflection back towards the DUT. A secondary reflection from the DUT may then be measured. Secondary reflections are usually very small.

Figure D-10 shows the relative size of primary and secondary reflections. The lower waveform is a copy of the upper waveform with the voltage scale greatly expanded about the baseline to show more clearly the shape of the secondary reflection. The DUT is a short circuit connected to the oscilloscope through a BNC connector. A secondary reflection from the DUT is visible at the right end of the baseline. Notice that the secondary reflection is indeed quite small. It has a peak voltage value of about 1.5 mV at 40 ps risetime, which is about 0.75% of the 200 mV incident step.

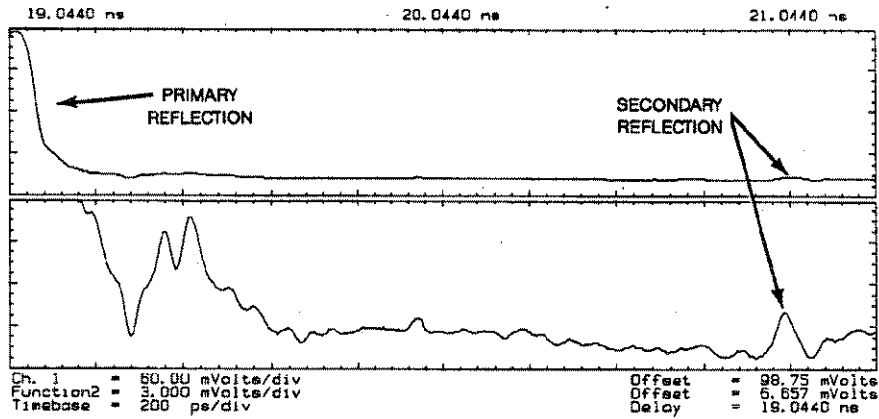
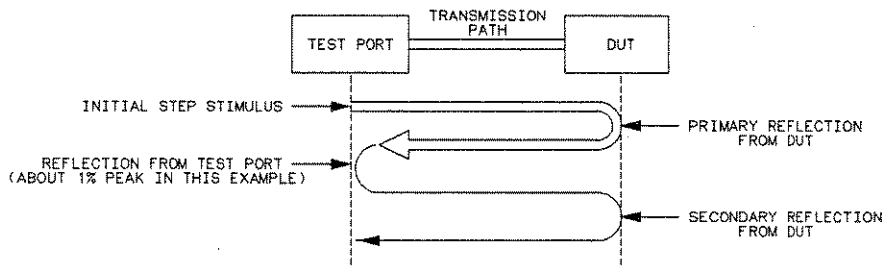
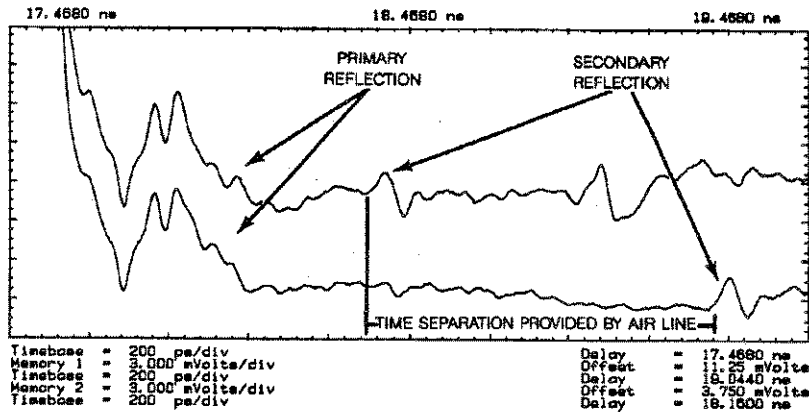

Figure D-10. The lower waveform is a copy of the upper waveform with the voltage scale greatly expanded about the baseline to show more clearly the shape of the secondary reflection

In step TDNA, a section of airline may be placed between the test port and the DUT to provide time separation between the primary reflection and secondary reflections. Figure D-11 illustrates the use of this technique. A secondary reflection is visible very close to the primary reflection in the top waveform. It is difficult to tell them apart. A short section of airline was placed between the DUT and the test port, resulting in the lower waveform. Note that the primary and secondary reflections are clearly separated. When the primary and secondary reflections are close together, the shapes of both may be distorted. If they are adequately separated in time, as is the case in the lower waveform, they no longer have a significant effect on each other.



54120800

Figure D-11. By adding a section of airline between the test port and the DUT, you can more clearly distinguish primary and secondary reflections

After an adequate separation has been achieved, a time window can be selected which does not include the undesirable secondary reflections. Figure D-12 illustrates the removal of secondary reflections from the measurement data using time windowing. The top waveform in figure D-12 contains a secondary reflection visible at the right end of the baseline. Note that moving the time window to the left (less delay after the trigger) removes the secondary reflection from the measurement without losing any of the primary reflection data. In CW TDNA, time windowing is cumbersome, thus a third calibration measurement is used.

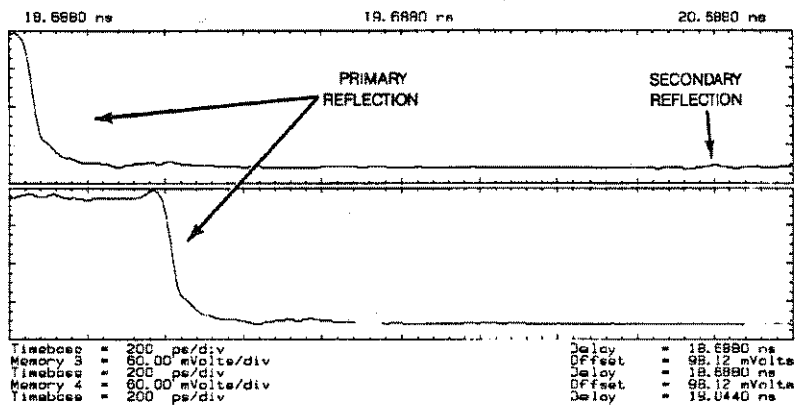

Figure D-12. Decreasing delay in the bottom waveform removes the secondary reflection shown at the right end of the baseline in the top waveform.

The Digital Filter Corrects the Measured Response

The digital filter describes how the frequency response of the test system varies from the ideal. If the calibration signal was passed through the filter, the result would be the ideal response. The filter removes errors by attenuating or amplifying and phase-shifting components of the frequency response as necessary.

Consider, for example, overshoot on the step stimulus. The frequency response of a DUT will include unwanted response to the overshoot. During normalization, the filter will phase-shift the frequencies responsible for the overshoot and thus attenuate the DUT response to the overshoot. The filter works similarly to correct for cable losses due to attenuation of high frequencies. It compensates for cable losses by boosting high frequency components in the DUT response back up to their proper levels.

The digital filter defines an ideal impulse response. A good basis for a normalization filter is a four-term, frequency-domain sum of cosines window, $W(f)$ (see equation 2) with the appropriate coefficients.

Equation 2:
$$W(f) = \sum_{k=0}^3 a_k \cos(2\pi f k / L): \text{ for } \frac{-L}{2} < f < \frac{L}{2}$$

$$= 0 \text{ elsewhere}$$

where: $a_0 + a_1 + a_2 + a_3 = 1$

54122m01

L = the full width of the window in hertz

f = frequency in hertz

A window of this form may be selected that rolls off quickly and has an almost Gaussian impulse response. The impulse response of the window defines the ideal response. The Gaussian response is considered ideal because it has a minimum settling time after a transition from one voltage level to another. Minimizing the settling time minimizes the interference between closely-spaced discontinuities, thus making them easier to see and analyze. The filter's bandwidth, and therefore risetime, is determined by the choice of L, the width of the sum of the cosines window. The actual normalization filter, F(f), is computed by dividing the sum of cosines window by the frequency response of the test system, S(f) (see equation 3). Frequency response is the Fourier transform of the impulse response.

Equation 3:
$$F(f) = \frac{W(f)}{S(f)}$$

54122M02

By varying the bandwidth of the filter, normalization can predict how the DUT would respond to ideal steps of various risetimes. The bandwidth of the test system is the frequency at which the frequency response is attenuated by 3 dB. The response beyond the cutoff frequency is not zero; it is only attenuated (figure D-13). By carefully changing the - 3 dB point in the frequency response, the bandwidth can be increased or decreased.

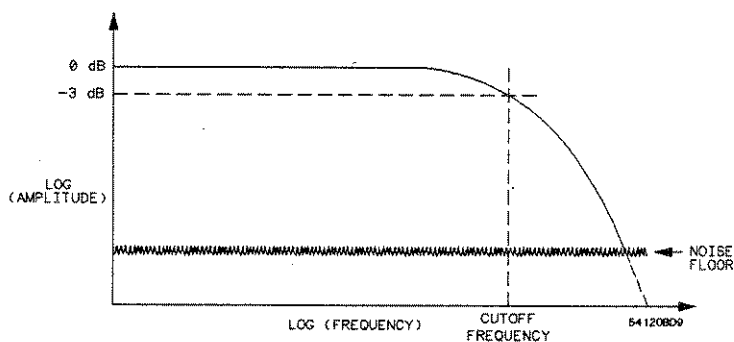

Figure D-13. Basic system frequency response

In the HP 54120 Series digitizing oscilloscopes with TDR capability, the user-specified risetime determines the bandwidth of the filter. Decreasing the bandwidth is accomplished by attenuating the frequencies that are beyond the bandwidth of interest (figure D-14). Increasing the bandwidth requires more consideration.

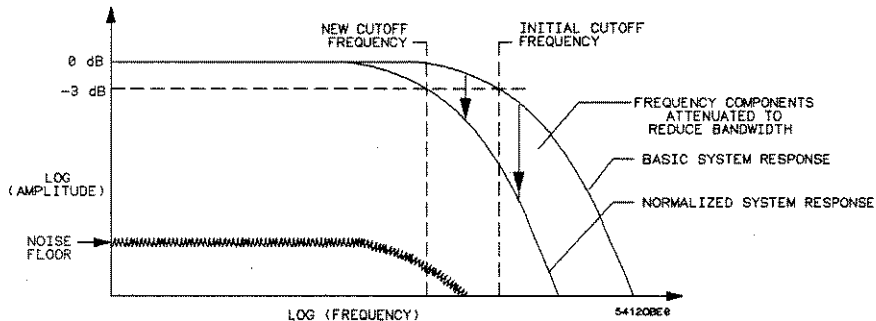

Figure D-14. Normalized system frequency response (system bandwidth reduced)

To increase the bandwidth, the response beyond the initial -3 dB frequency needs to be amplified. While this is a valid step, it is important to realize that the system noise at these frequencies and at nearby higher frequencies is also amplified (see figure D-15).

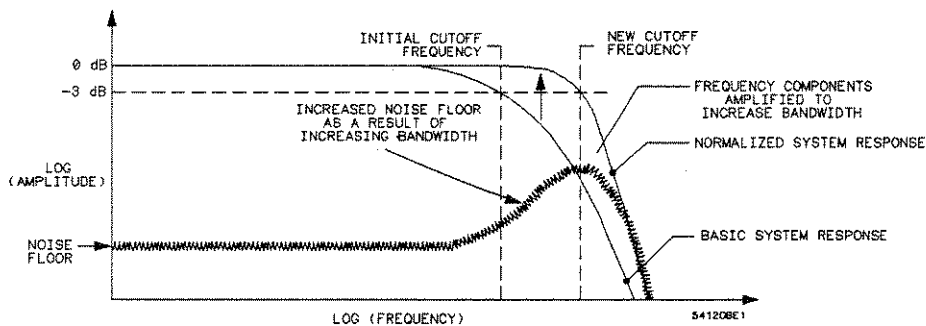

Figure D-15. Normalized system frequency response (system bandwidth increased)

The limit to which the risetime of real systems may be extended is determined by the noise floor. In real systems, there is a point beyond which the amplitude of the frequency response data is below the noise floor. Any further increase in bandwidth only adds noise.

Because waveform averaging reduces the initial level of the noise floor, **WAVEFORM AVERAGING SHOULD BE USED WHEN NORMALIZING.**

An equation can be used to describe the filtering process. The test system frequency response, $S(f)$, can be thought of as the ideal frequency response defined by the sum of cosines window, $W(f)$ multiplied by an error frequency response, $E(f)$ (see equation 4). Further, the measured response of the DUT, $M(f)$, can be thought of as the DUT frequency response, $D(f)$, multiplied by the test system frequency response, $S(f)$. Filtering is accomplished by multiplying the measured frequency response of the DUT by the filter, $F(f)$. $N(f)$ is the normalized (filtered) frequency response of the DUT. Equation 5 describes the filtering process using the above definitions.

Equation 4:

$$S(f) = W(f) E(f)$$

Equation 5:

$$\begin{aligned} M(f) &= D(f) S(f) \\ N(f) &= M(f) F(f) \\ N(f) &= D(f) S(f) F(f) \\ N(f) &= D(f) W(f) E(f) \frac{W(f)}{W(f) E(f)} \\ N(f) &= D(f) W(f) \end{aligned}$$

The normalized response is the DUT frequency response multiplied by the frequency response of an ideal impulse. Note that the error response has been removed, and that $N(f)$ is an impulse response.

When $N(f)$ is converted to the time domain,* the result is $n_i(t)$, a normalized impulse response.

Because a step stimulus is used, a normalized step response, $n_s(t)$, is desired. An ideal step can be defined in the time domain by convolving $w(t)$, the ideal impulse response, with $u(t)$, the unit step function. Given this modification, equation 6 further describes the effect of the filtering process.

Equation 6:

$$\begin{aligned} n_i(t) &= d(t) * w(t) \\ n_s(t) &= n_i(t) * u(t) \\ n_s(t) &= d(t) * [w(t) * u(t)] \end{aligned}$$

* The Bracewell transform is under license from Stanford University.

The normalized response, $n_s(t)$, is the impulse response of the DUT convolved with the ideal step defined by the convolution of $w(t)$ with $u(t)$. The result of normalization is, therefore, the response of the DUT to an ideal step of risetime determined by $w(t)$. By varying the width, L , of $W(f)$, normalization can predict the response of the DUT at multiple risetimes based on a single-step response measurement.

Putting It All Together

The actual normalization of a DUT response is accomplished in two steps. A stored waveform, derived in the calibration and which represents the systematic errors, is subtracted from the measured DUT waveform. This result is then convolved with the digital filter to yield the response of the DUT, normalized to an ideal step input with the user-specified risetime.

Figure D-16 illustrates the power of normalization. It shows discontinuities in a transmission path measured using TDR. The bottom waveform was measured in a test system with an approximate risetime of 35 ps. The top waveform is the bottom waveform normalized to 20 ps risetime. Note that in the bottom waveform there appears to be only one inductive discontinuity. Using normalization, it becomes obvious that there are actually two inductive discontinuities. Because it is difficult to build a 20 ps risetime step stimulus with a clean response and a test system with adequate bandwidth to measure it, this measurement probably could not have been made without normalization.

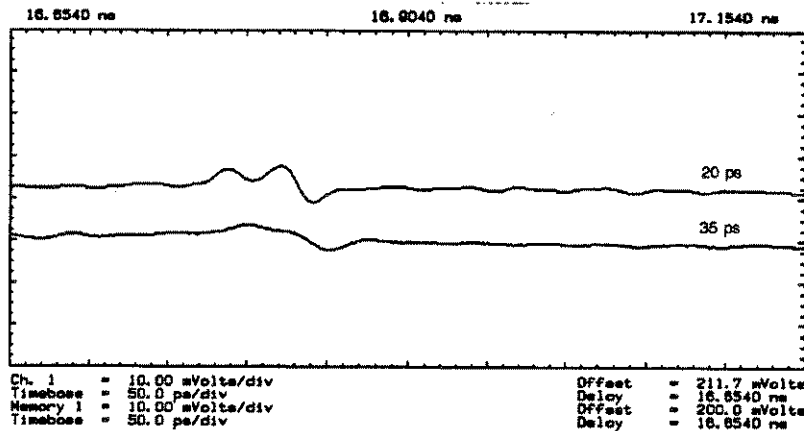
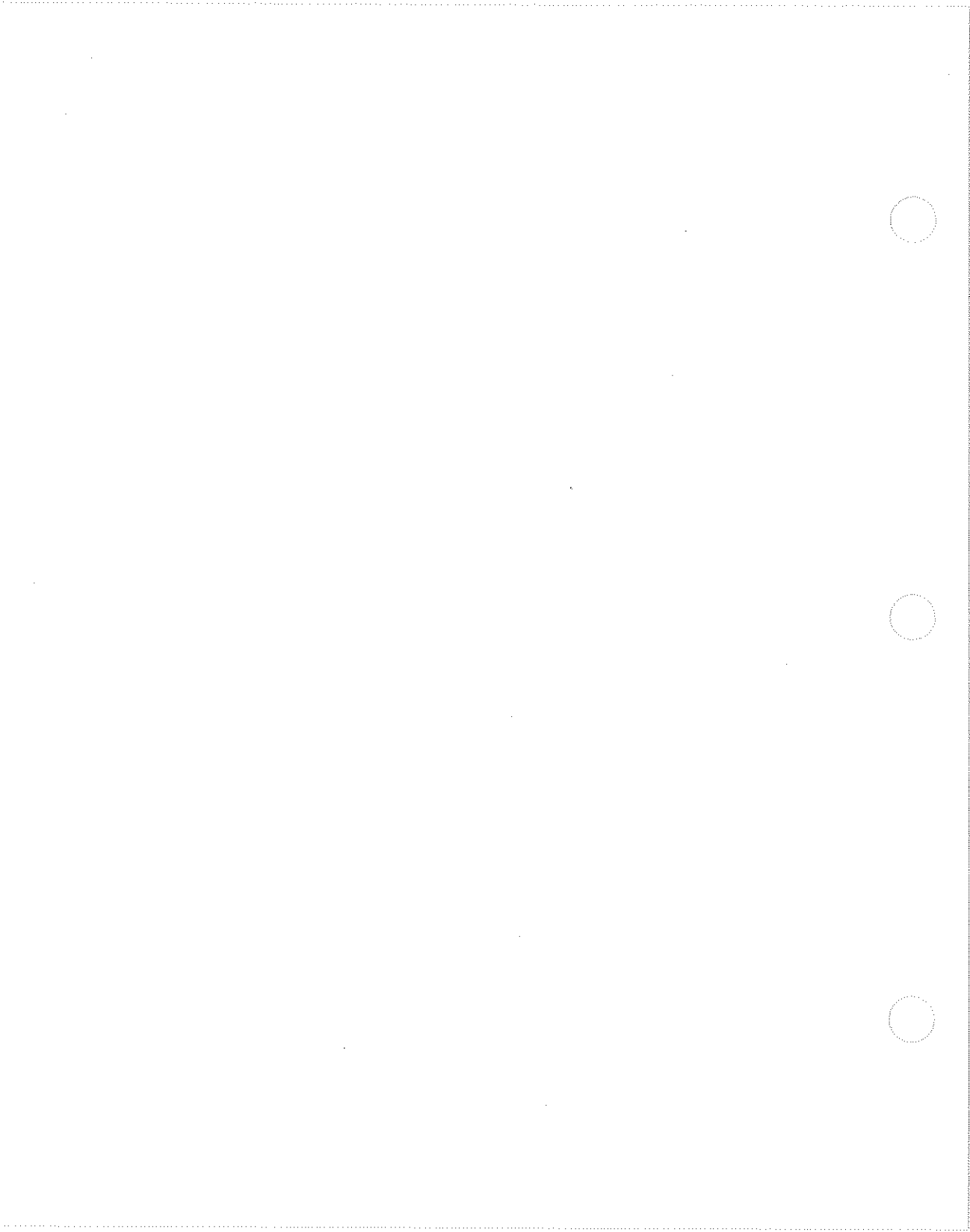

Figure D-16. The top waveform is the same signal as the bottom waveform, except that it has been normalized. Normalization reveals that there are actually two inductive discontinuities, rather than one as shown in the bottom waveform



Transmission Line Theory Applied to Digital Systems

E

Introduction

Understanding the operation of transmission lines used in conjunction with high speed MECL circuits is necessary in order to be able to completely characterize system operation. This appendix describes transmission lines with respect to both line reflections and propagation delay times. Also discussed will be the use of the Time Domain Reflectometer (TDR) for measuring transmission line characteristics.

Transmission Line Design

A transmission line, as used with high speed MECL, is a signal path that exhibits a characteristic impedance. Coaxial cables and twisted pairs have a defined characteristic impedance and are commonly referred to as transmission lines. Equally important, printed circuit fabrication of microstrip and stripline results in closely-controlled transmission-line impedance.

Transmission lines may be approximated by the lumped constant representation shown in Figure E-1. The effect of the line resistance R_0 , of the line on characteristic impedance, Z_0 , is negligible, but it will cause some loss in voltage at the receiving end of long lines. The inductance and capacitance of the line in the presence of a ground plane are a function of the dielectric medium, the thickness and width of the line, and the spacing from the ground plane. The inductance and capacitance of the line can be measured using an LC meter.

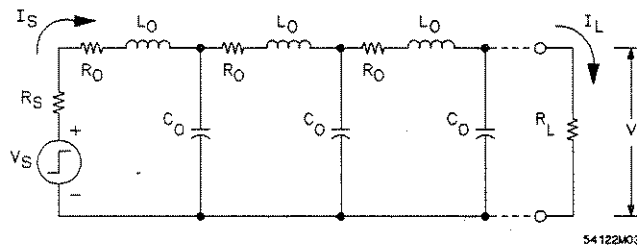

Figure E-1. Equivalent Circuit of a Transmission Line

This appendix is reprinted with permission from Motorola Inc. MECL System Design Handbook, pages 121-144.

HP 54121T
Front-Panel Reference

TDNA Fundamentals
E-1

Microstrip and strip lines may be treated as operating in the transverse electro-magnetic (TEM) mode. Although microstrip propagation is not purely TEM because of non-uniform dielectrics for all practical purposes it can be treated as TEM. The characteristic impedance of the line is:

$$Z_0 = \sqrt{L_0/C_0}$$

and the propagation delay is: $t_{pd} = \sqrt{L_0 C_0} = Z_0 C_0$

For a homogeneous medium the propagation delay is also equal to:

$$t_{pd} = \sqrt{\mu e} = \sqrt{\mu_0 \mu_r e_0 e_r}$$

Where μ is the permeability and e is the permittivity of the medium. In transmission lines, the relative permeability (μ_r) is unity
 $\mu_0 = 4\pi \times 10^{-7}$ Henry/metre, and $e_0 = 8.85 \times 10^{-12}$ Farad/metre.

Therefore, $t_{pd} = 1.017 \sqrt{e_r}$ ns/ft, e_r is the relative dielectric constant. For microstrip lines on glass epoxy boards $e_r = 3.0$, and for strip lines $e_r = 5.0$.

From transmission line theory for a lossless line, it can be shown that a signal sent down a line of constant characteristic impedance will travel along the line without distortion. However, when the signal reaches the end of the line, a reflection will occur if the line is not properly terminated with the characteristic impedance of the line.

Figure E-2 shows a MECL gate driving a transmission line terminated in a load resistor, R_L . A negative-going transition on the input to the gate will result in a positive-going transition at the NOR output. The MECL gate is essentially a VHF linear differential amplifier with a bandwidth of $0.37/t_r$ (MHz), where t_r is the risetime of the gate in nanoseconds. The effect of the capacitance of the transmission line will not decrease the bandwidth or affect the risetime at the MECL gate output. However, the signal at the end of a long transmission line may be attenuated due to bandwidth limitations in the particular type of transmission line used. For the purposes of this discussion, a long line is defined as a line having a propagation delay larger than the risetime of the driving circuit divided by two: $T_D > t_r/2$.

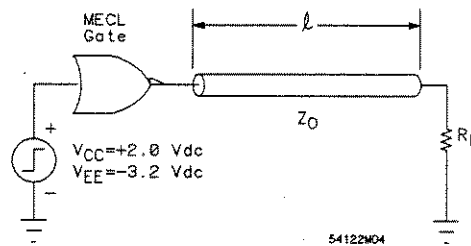

Figure E-2. MECL Gate Driving a Transmission Line

The circuit of Figure E-2 can be redrawn as shown in Figure E-3 to include the equivalent circuit of the MECL gate. The resistor, R_0 , is the output source impedance (for MECL 10K/10KH it is 7Ω , and MECL III it is 5Ω). According to theory, the risetime of the driving voltage source is not affected by the capacitance of the transmission line. Except for skin effect and dielectric losses, the signal will remain undistorted until it reaches the load. The equation representing the voltage waveform going down the line as a function of distance and time can be written as:

$$V_1(X, t) = V_A(t) \cdot U(t - X t_{pd}), \text{ for } t < T_D. \quad (1)$$

where: $V_A(t) = E_S(t) \left(\frac{Z_0}{Z_0 + R_0} \right)$

- V_A = voltage at point A,
- X = the distance to an arbitrary point on the line,
- ℓ = total line length,
- t_{pd} = propagation delay of the line in ns/unit distance,
- $T_D = \ell t_{pd}$,
- $U(t)$ = a unit step function occurring at $t=0$, and
- $E_S(t)$ = the source voltage at the sending end of the line.

When the incident voltage V_1 reaches the end of the long line, a reflected voltage V'_1 will occur if $R_L \neq Z_0$. The reflection coefficient at the load, ρ_L , can be obtained by applying Ohm's Law.

The voltage at the load is $V_1 + V'_1$ which must be equal to $(I_1 + I'_1) R_L$. But $I_1 = V_1 / Z_0$, and $I'_1 = -V'_1 / Z_0$ (the minus sign is due to V'_1 , travelling toward the source). Therefore,

$$V_1 + V'_1 = \left(\frac{V_1}{Z_0} - \frac{V'_1}{Z_0} \right) R_L \quad (2)$$

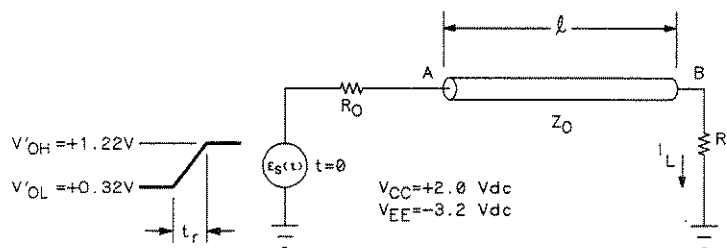

Figure E-3. Equivalent MECL Gate Output, Driving a Transmission Line

By definition $\rho_L = \frac{\text{reflected voltage}}{\text{incident voltage}} = \frac{V'_1}{V_1}$

Solving for V'_1/V_1 in equation 2, and substituting in the relation for ρ_L results in:

$$\rho_L = \frac{R_L - Z_0}{R_L + Z_0} \quad (3)$$

Similarly, the reflection coefficient at the source is:

$$\rho_S = \frac{R_0 - Z_0}{R_0 + Z_0} \quad (4)$$

By summing the incident voltage V_1 (eq. 1), together with similar voltage contributions from the various orders of reflection (due to ρ_L and ρ_S), a general equation for total line voltage can be written, and used to develop practical design information:

$$\begin{aligned} V(X, t) = & V_A(t) \left[U(t - t_{pd}X) + \rho_L U(t - t_{pd}(2l - X)) \right. \\ & + \rho_L \rho_S U(t - t_{pd}(2l + X)) + \rho_L^2 \rho_S U(t - t_{pd}(4l - X)) \\ & \left. + \rho_L^2 \rho_S^2 U(t - t_{pd}(4l + X)) + \dots \right] + V_{dc} \end{aligned} \quad (5)$$

Note that as time progresses, the U step function brings successively higher order reflection coefficient terms into $V(X, t)$. Successive terms may be positive or negative, depending on the resulting sign and so damped ringing can occur. Equation 5 expresses the voltage at any point on the line, X, for any time, t. The equation can be used graphically with a lattice diagram to find $V(X, t)$.

Example 1

Figure E-4 will be used to illustrate the lattice diagram method for finding $V(X,t)$ and the use of equation 5. The source impedance of the MECL III gate is 5Ω , resulting in a reflection coefficient at the source of -0.82 for a line impedance of 50Ω .

The load resistor is arbitrarily chosen to be 30 percent greater (65Ω) than the characteristic impedance (50Ω) so that reflections will occur. The resulting reflection coefficient at the load is $\rho_L = +0.013$. Two vertical lines are drawn to represent the input of the line, point A, and the output of the line, point B. A line is drawn from point A to point B before $t = 0$ to represent the steady state conditions. Note that for $V_{CC} = 2 \text{ V}$ and $V_{EE} = -3.2 \text{ V}$, the nominal logic levels are approximately logic 0 = 0.3 V , and logic 1 = 1.14 V . (These power supply conditions are used to permit convenient measurements when output resistors are returned directly to ground). For steady state conditions, the line looks like a short line with a resistance equal to R_{dc} . It can be assumed that R_{dc} is negligible for this example.

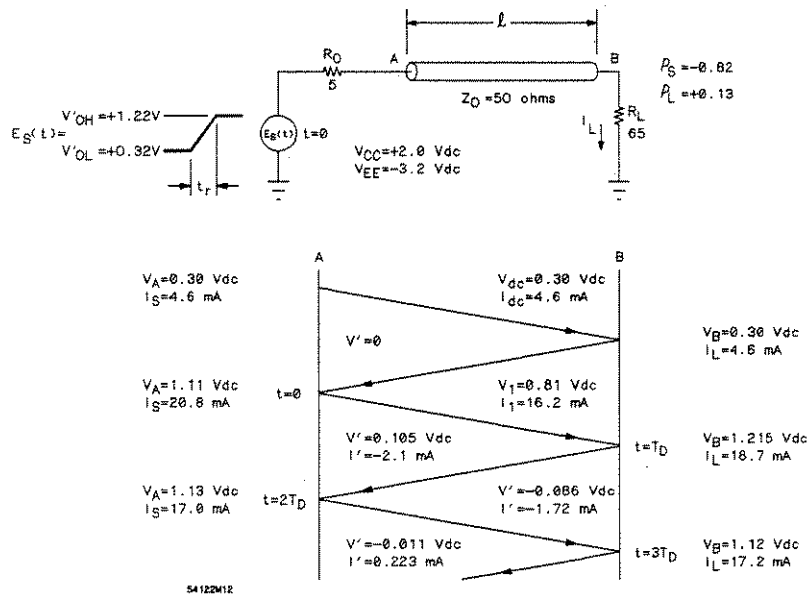

Figure E-4. Lattice Diagram for a Typical Reflection Example

The voltage and current at points A and B are the same initially, as shown in figure E-4. At $t = 0$, the voltage at the source switches from a logic 0 to a logic 1 level. The voltage term, $V_A(t)$, in equation 1 is:

$$V_A(t) = (V'_{OH} - V'_{OL}) \left(\frac{Z_o}{Z_o + R_o} \right) = V_1 = 0.81 \text{ volt}$$

where: $(V'_{OH} - V'_{OL}) = E_S(t)$ = internal voltage swings in the circuit = ΔV_{INT}

Therefore, at time $t = 0$ a voltage waveform, $V = 0.81 \text{ V}$, and a current, $I = 16.2 \text{ mA}$, travel down the line as shown in figure E-4 by the line from $t = 0$ to $t = T_D$ (T_D is the time it takes for the wavefront to travel down the length of line, ℓ). Next, a line is drawn from $t = T_D$ to $t = 2T_D$. Voltage and current values are indicated. Note that here the reflected current is negative, indicating the current is flowing back toward the source; the reflection coefficient for the current is a minus one times the reflection coefficient for the voltage.

To find the voltage at point B for $t = T_D$ all the voltages arriving at and leaving from this point are summed. The same is done to determine the load current. The process continues until the voltage at the load approaches the new steady state condition in the example, when $t = 3T_D$. (The steady state logic 1 voltage is actually 1.13 V).

This example indicates that for a case in which the load resistor is 30% higher than the characteristic impedance, 85 mV of overshoot and 10 mV of undershoot would occur. Generally, as far as noise immunity is concerned, only the undershoot need be considered. The typical noise immunity (or noise margin) for a MECL circuit is greater than 200 mV. Since the undershoot in this example was 10 mV, the typical noise immunity would exceed 190 mV. In actual system design, typically more than 100 mV of undershoot can be tolerated. Regarding overshoot, 300 mV can be tolerated, except in some early ac coupled flip-flops (MECL I and II). This restriction insures that saturation of the input transistor does not occur (if it did, the gate would slow down). If a 100Ω load resistor were used in Figure E-4, the resulting overshoot would be about 220 mV and the undershoot, about 80 mV. In effect then, if the load resistor is twice the characteristic impedance, the noise margin is typically 120 mV which is more than acceptable for MECL circuits.

A slightly different situation can exist when the output of the MECL gate switches from a logic 1 to a logic 0. The output of the MECL gate will turn off if the termination resistor, R_L , is somewhat larger than the characteristic impedance of the line. For the conditions in Figure E-4, the output transistor of the MECL gate will turn off at $t = 0$ for the negative going transition, when $R_L > 70 \Omega$.

An equation for the value for R_L at which the gate will turn off can be derived as follows. The maximum voltage change at point A Figure E-4, (due to turning off the output transistor) is the product of the dc current in the line and the characteristic impedance of the line:

$$\Delta V_A = I_{LINE} (Z_0) = \frac{V'_{OH}}{R_0 + R_L} (Z_0)$$

The voltage at point A is also dependent on the internal resistance of the driving gate R_0 and the internal logic swing.

$$\Delta V_A = \frac{Z_0}{R_0 + Z_0} (\Delta V_{INT})$$

Equating the two and solving for R_L :

$$R_L = \frac{V'_{OH} (R_0 + Z_0)}{\Delta V_{INT}} - R_0 \quad (6)$$

Thus for the conditions given in Figure E-4, the output transistor will turn off at

$$t=0 \text{ when } R_L = \frac{1.22 (5+50)}{0.9} - 5 = 70 \Omega \text{ is exceeded.}$$

The case for which the MECL output turns off is not in itself a serious problem, although it makes a thorough analysis more difficult. Two reflection coefficients must be used at the sending end and a piecewise approach used in determining the voltage reflections.

Example 2

The condition for a negative-going transition will now be analyzed. Refer to Figure E-5. The steady state high logic level current is:

$$I_{dc} = \frac{V'_{OH}}{R_o + R_L} = 11.6 \text{ mA}$$

For the conditions shown in Figure E-5, the use of equation 6 shows that the load resistor is indeed larger than required to turn off the output transistor during a negative transition.

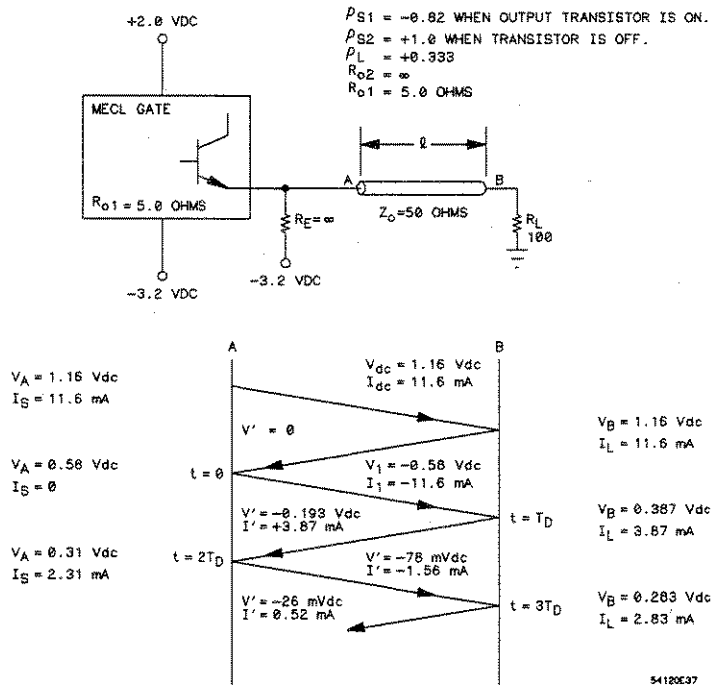

Figure E-5. Lattice Diagram for Negative-Going Voltage Transition

To determine the voltage V_1 at $t = 0$, the following equation results from the application of Ohm's Law to the circuit:

$$V_1 = - \left(I_{dc} + \frac{V_A + 3.2 + V_1}{R_E} \right) Z_o \quad (7)$$

For the example shown, let $R_E = \infty$, then:

$$V_1 = -I_{dc}Z_o \quad (8)$$

Solving equation 8, $V_1 = 0.58$ V. The implication of this result is that stubbing off the line with gate loads in a distributed fashion is not recommended, due to the reduced initial voltage swing. However, it would be acceptable to lump the loads at the end of the line.

Since the value of the load resistor is greater than the characteristic impedance, the voltage swing at the load resistor is greater than V_1 by the amount of $\rho_L V_1$, (in this example, 193 mV). When $t = T_D + T_1$, the voltage at B is equal to 0.387 V; so 82 mV of undershoot occurs. Undershoot on the falling edge is defined as the amount of voltage step above the nominal logic 0 level of 0.305 V. Overshoot in the low logic state is defined as the amount of voltage change below the logic 0 level.

In Figure E-6, the voltage waveforms at points A and B of this example are shown as a function of time. To be more realistic, the waveform in the figure is shown to be a negative-going ramp rather than an abrupt step function. The term, T_1 , is the amount of time it takes for the waveform at A to switch to the level at which the output transistor turns off. The fall time of the signal would have been longer by an amount equal to:

$$T'_1 = \frac{(1.16 - 0.305)}{(1.16 - 0.58)} T_1$$

if the termination resistor has been 70Ω or less.

The reflected voltage waveform leaving point B at $t = T_D$ arrives at point A at $t = 2T_D$. The source impedance is very high initially ($\rho_S = +1.0$), with the output transistor being in the off condition until the voltage at A falls to 0.32 V. Then, the source impedance changes to 5Ω ($R_S = -0.82$).

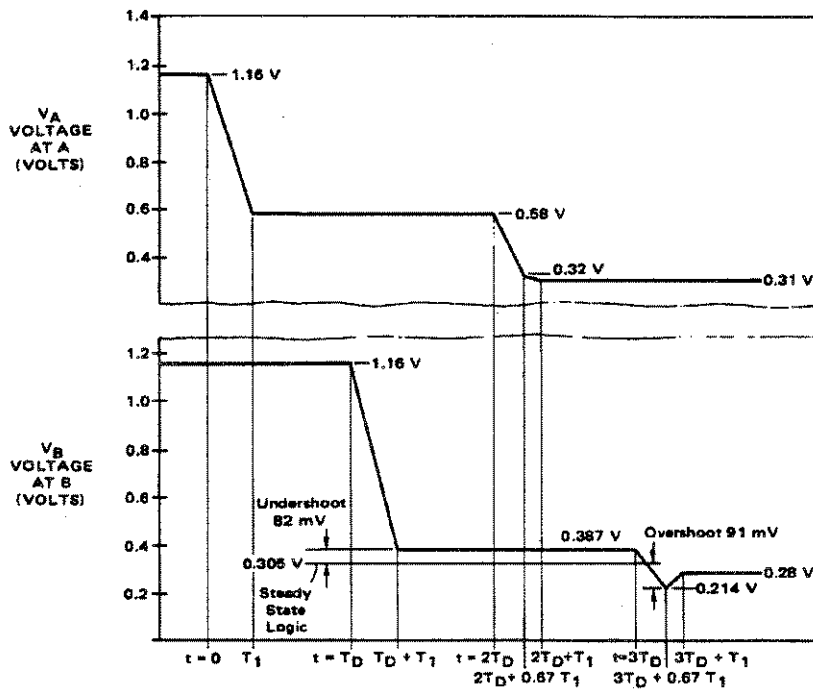

Figure E-6. Voltage Waveforms for Points A and B in Example 2

The following formula may be used to determine the point at which the transistor turns on:

$$\Delta V_{\text{source}} = V_1 + \rho_S V_1 = 2V_1 \text{ (valid prior to transistor conduction) } \quad (9)$$

where V_1 is now the incident voltage approaching the source and ΔV_{source} is the change in voltage at the source necessary to turn the transistor on.

In this example the actual voltage change for conduction to occur is: $\Delta V_{\text{source}} = 0.32 - 0.58 = -0.26 \text{ V}$. Therefore, the voltage waveform approaching the source (193 mV) can be broken into two signals $V_{11} = -0.13$, and $V_{12} = -0.063 \text{ V}$. The reflected voltage due to V_{11} is $V'_{11} = -0.13 \text{ V}$, and for V_{12} , the reflected voltage is $V'_{12} = (-0.82)(-0.063) = 0.052 \text{ V}$. The two reflected voltages of opposite polarity at point A going toward point B are the reason for the increased overshoot of short duration at point B, when $t = 3T_D + (0.13 \div 0.193) T_1$. Refer to figure E-6.

The steady state voltage reflection that occurs after $t = 2T_D + T_1$ is the sum of -0.13 V and $+0.052 \text{ V}$, equal to -78 mV as shown in Figure E-5. The steady state voltage reflection can be calculated using the relation:

$$V' = \rho_{S2} \Delta V_{\text{source}} \left(\frac{1 + \frac{Z_0}{R_{o2}}}{2} \right) + \rho_{S1} \left[V_1 - \Delta V_{\text{source}} \left(\frac{1 + \frac{Z_0}{R_{o2}}}{2} \right) \right] \quad (10)$$

Equation 10 may be illustrated by solving for the steady state reflection voltage at $t = 2T_D + T_1$:

$$V' = (+1.0)(0.32 - 0.58) \left(\frac{1 + \frac{50}{\infty}}{2} \right) + (-0.82) \left[-0.193 - (0.32 - 0.58) \left(\frac{1 + \frac{50}{\infty}}{2} \right) \right] = 78 \text{ mV}$$

From the analysis of Figure E-5, it is concluded that the MECL gate can safely drive the transmission line ($Z_0 = 50 \Omega$) with a 100Ω load resistor and with the gate loads lumped at the end of the line, since less than 100 mV of undershoot occurs. The remaining noise margin will be typically greater than 100 mV .

**Signal Propagation
Delay for Microstrip
and Strip Lines with
Distributed or
Lumped Loads**

The propagation delay, t_{pd} , has been shown to be 1.77 ns/ft for microstrip lines and 2.26 ns/ft for strip lines, when a glass epoxy dielectric is the surrounding medium. The propagation delay time of the line will increase with gate loading and the altered delay can be derived as follows. The unloaded propagation delay for a transmission line is:

$$t_{pd} = \sqrt{L_o C_o}$$

If a lumped load, C_d , is placed along the line, then the propagation delay will be modified to t'_{pd} :

$$t'_{pd} = \sqrt{L_o (C_o + C_d)} = \sqrt{L_o C_o} \sqrt{1 + \frac{C_d}{C_o}} = t_{pd} \sqrt{1 + \frac{C_d}{C_o}} \quad (11)$$

where L_o and C_o are the intrinsic line inductance and capacitance per unit length.

Therefore, the signal propagation down the line will increase by the factor of:

$$\sqrt{1 + \frac{C_d}{C_o}}$$

A MECL gate input should be considered to have 5 pF of capacitance for ac loading considerations (includes stray capacitance). If 4 gate loads are placed on a 1 foot signal line, then the distributed capacitance, C_d , is equal to 20 pF/ft or 1.67 pF/in. As an example assume it is desired to find the propagation delay increase for a 50 Ω microstrip line on a glass epoxy board. Assume that the line width is chosen to be 25 mils; then the dielectric material should have a thickness of 15 mils to yield $Z_o = 50 \Omega$ and the capacitance of the line is 35 pF/ft. Therefore, the modified propagation delay would be:

$$t'_{pd} = 1.77 \text{ ns/ft} \sqrt{1 + \frac{20}{35}} = 2.21 \text{ ns/ft}$$

For a 50 Ω strip line on a glass epoxy board with a 15 mil spacing between the strip line and ground plane, a 12 mil width would be required, and the strip line would exhibit a capacitance of 41 pF/ft. The modified propagation delay for such a strip line would be:

$$t'_{pd} = 2.26 \text{ ns/ft} \sqrt{1 + \frac{20}{41}} = 2.75 \text{ ns/ft}$$

Notice that the propagation delay for the strip line and the microstrip line change by approximately the same factor when the separation between the line and ground plane, and the characteristic impedance are the same. However, the line width of the strip line is less (by a factor of 2) than the microstrip line for the same characteristic impedance.

It should be noted that to obtain the minimum change and lowest propagation delay as a function of gate loading, the lowest characteristic impedance line should be used. This will result in the largest intrinsic line capacitance. With MECL 10K/10KH the lowest impedance that can be used is about 35Ω ($V_{TT} = -2.0 \text{ V}$ $R_{TT} = 35 \Omega$).

According to theory, whenever an open line (stub) is driven by a pulse, the resultant undershoot and ring are held to about 15 percent of the logic swing if the two way delay of the line is less than the risetime of the pulse. The maximum line length, l_{\max} may be calculated using the equality:

$$l_{\max} = \frac{t_r}{2t'_{pd}} \text{ (inches)}$$

where t_r is the risetime of the pulse in nanoseconds, and t'_{pd} is the modified propagation delay in nanoseconds/inch from equation 11.

A quadratic equation for maximum line length for G-10 fiber glass epoxy microstrip conductors may be written in terms of C_D , C_O and t_r as

$$l_{\max}^2 + \frac{C_D}{C_O} l_{\max} - 11.1 t_r^2 = 0 \text{ (for microstrip lines)} \quad (12)$$

where C_D is total gate capacitance.

An equation for maximum open line length for a strip line (using G-10 fiber glass epoxy material) can be written in a similar fashion. The result is:

$$l_{\max}^2 + \frac{C_D}{C_O} l_{\max} - 7.1 t_r^2 = 0 \text{ (for strip lines)} \quad (13)$$

Using the lattice diagram, it has been found that the rule of thumb used to derive equations 12 and 13 should be modified for an open line because the incident voltage doubles at the end of the line. This results in a faster risetime at the receiving end of an unloaded line than at the driving end. An approximate value of maximum open line length can be generated from equations 12 and 13 if the risetime that is substituted into the equations is multiplied by an adjustment factor, 0.75. This maintains an approximate overshoot and undershoot of less than 35% and 12% respectively.

To demonstrate how equations 12 and 13 may be used, the maximum open line length will be computed for a 50 Ω line with a fanout of one MECL 10K gate. Using the equation $t_{pd} = Z_0 C_0$, the line capacitance, C_0 , is found to be $C = 2.96$ pF/in for microstrip, and $C_0 = 3.76$ pF/in for strip line. For a fanout of one, C_D is equal to 5 pF when the device is in a socket. The risetime for MECL 10K is 3.5 ns which means that a value of $t_r = 0.75 \times 3.5 = 2.6$ ns should be used in the equations. Solving equations 12 and 13, max for a 50 Ω microstrip line and $l_{max} = 6.2$ inches for a 50 Ω strip line.

Equations 12 and 13 can be very useful in finding the approximate maximum line length under various conditions. Suggested maximum open line lengths for MECL 10K/10KH and MECL III are tabulated in tables E-1, E-2, and E-3 for various fanouts and line impedances. For these tables, line lengths are chosen to limit overshoot to 3.5% of logic swing and undershoot to 12%. Note that the tables give the maximum line lengths for fanouts of 1, 2, 4, and 8 for various types of lines with a wide range of characteristic impedances.

Table E-1. Maximum Open Line Length for MECL 10,100 (Gate Rise Time = 3.5 ns)

	Z ₀ (Ohms)	Fanout = 1 (2.9 pF) ℓ Max (in)	Fanout = 2 (5.8 pF) ℓ Max (in)	Fanout = 4 (11.6 pF) ℓ Max (in)	Fanout = 8 (23.2 pF) ℓ Max (in)
Microstrip (Propagation Delay 0.148 ns/in.)	50	8.3	7.5	6.7	5.7
	68	7.0	6.2	5.0	4.0
	75	6.9	5.9	4.6	3.6
	82	6.6	5.7	4.2	3.3
	90	6.5	5.4	3.9	3.0
	100	6.3	5.1	3.6	2.6
Stripline (Propagation Delay 0.188 ns/in.)	50	6.5	5.9	5.2	4.5
	68	5.6	4.9	3.9	3.2
	75	5.3	4.7	3.6	2.8
	82	5.2	4.4	3.3	2.6
	90	5.1	4.3	3.1	2.4
	100	4.9	4.0	2.8	2.1
Backplane (Propagation Delay 0.140 ns/in.)	100	6.6	5.4	3.8	2.8
	140	5.9	4.3	2.8	1.9
	180	5.2	3.6	2.1	1.3

Table E-2. Maximum Open Line Length for MECL 10,200, MECL 10H100, 10H210, 10H211 (Gate Rise Time = 2 ns)

	Z ₀ (Ohms)	Fanout = 1 (3.3 pF) ℓ Max (in)	Fanout = 2 (6.6 pF) ℓ Max (in)	Fanout = 4 (13.2 pF) ℓ Max (in)	Fanout = 8 (26.4 pF) ℓ Max (in)
Microstrip (Propagation Delay 0.148 ns/in.)	50	3.5	2.8	1.9	1.2
	68	3.2	2.3	1.5	0.8
	75	3.0	2.2	1.3	0.7
	82	2.9	2.0	1.2	0.6
	90	2.8	1.9	1.0	0.5
	100	2.6	1.8	0.9	0.4
Stripline (Propagation Delay 0.188 ns/in.)	50	2.8	2.2	1.5	1.0
	68	2.5	1.9	1.2	0.6
	75	2.4	1.7	1.1	0.6
	82	2.3	1.6	0.9	0.5
	90	2.2	1.5	0.8	0.4
	100	2.0	1.4	0.7	0.1
Backplane (Propagation Delay 0.140 ns/in.)	100	2.8	1.8	0.9	0.4
	140	2.4	1.4	0.5	0.3
	180	2.0	1.0	0.3	0.1

Table E-3. Maximum Open Line Length for MECL III, MECL 10H209 (Gate Rise Time 1.1 ns)

	Z ₀ (Ohms)	Fanout = 1 (3.3 pF) ℓ Max (in)	Fanout = 2 (6.6 pF) ℓ Max (in)	Fanout = 4 (13.2 pF) ℓ Max (in)	Fanout = 8 (26.4 pF) ℓ Max (in)
Microstrip (Propagation Delay 0.148 ns/in.)	50	1.6	1.1	0.7	0.6
	68	1.4	0.8	0.5	0.4
	75	1.3	0.8	0.4	0.3
	82	1.2	0.7	0.4	0.2
	90	1.1	0.6	0.3	0.2
	100	1.0	0.5	0.2	0.1
Stripline (Propagation Delay 0.188 ns/in.)	50	1.2	0.8	0.6	0.5
	68	1.1	0.7	0.4	0.3
	75	1.0	0.6	0.3	0.2
	82	0.9	0.6	0.3	0.2
	90	0.9	0.5	0.2	0.1
	100	0.8	0.4	0.2	0.1
Backplane (Propagation Delay 0.140 ns/in.)	100	1.1	0.6	0.2	0.1
	140	0.8	0.3	0	0
	180	0.6	0.2	0	0

The maximum line lengths are also given for various characteristic impedances in the backplane. The characteristic impedance of the backplane should be between 100 Ω and 180 Ω if a ground screen is used. For MECL 10K from table E-1, 5.9 inches of open backplane wiring can be driven for a fanout of one.

It should be remembered that these line lengths are based on 100 mV maximum undershoot, and are not absolute maximum lengths with which MECL circuits will operate. It is possible to use longer unterminated lines than shown – the tradeoff being an associated loss of noise immunity due to increased ringing.

From these calculations, it can be concluded that lower impedance lines result in longer line lengths before termination is required. The lower impedance lines are preferred over higher impedance lines because longer open lines are possible, and the propagation delay down the line is reduced. In addition, more stubbed-off gate loads can be driven with a terminated line due to its higher capacitance per unit length.

**Microstrip
Transmission Line
Techniques
Evaluated Using
TDR Measurements**

The time domain reflectometer (TDR) employs a step generator and an oscilloscope in a system which might be described as "closed-loop radar." Refer to figure E-7. In operation, a voltage step is propagated down the transmission line under investigation. Both the incident and reflected voltage waves are monitored on the oscilloscope at a particular point on the line.

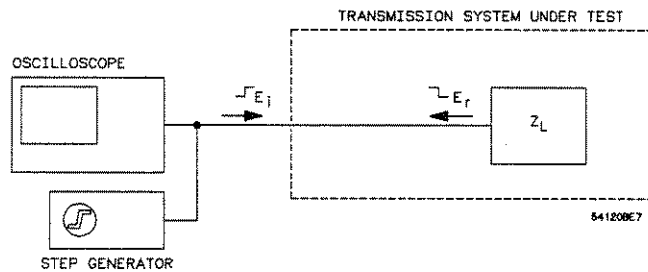

Figure E-7. Time Domain Reflectometer

For the examples the incident voltage setup, E_1 , is a positive edge with an amplitude of 1 V and a risetime of 30 ps. It is generated from a source impedance of 50 Ω . Also, the output edge has very little overshoot (less than $\pm 5\%$).*

This TDR technique reveals the characteristic impedance of the line under test. It shows both the position and the nature (resistive inductive, or capacitance) of each discontinuity along the line, and signifies whether losses in a transmission system are series losses or shunt losses. All of this information is immediately available from the oscilloscope's display. An example of a microstrip line evaluated with TDR techniques is shown below:

TDR Example 1: Board material: Norplex Type G-10
 Dielectric thickness: $h = 0.062$ inch;
 Copper thickness: $t = 0.0014$ inch;
 Dielectric constant: $\epsilon_r = 5.3$.

The formula for the characteristic impedance is:

$$Z_0 = \frac{87}{\sqrt{\epsilon_r + 1.41}} \ln \left(\frac{5.98 h}{0.8w + t} \right) \quad (14)$$

* The original text was written using the HP 1415A. Since then the HP 54120 Series of Digitizing Oscilloscopes has been introduced.

For a line width, $w = 0.1$ inch, the characteristic impedance of the line is calculated to be 51Ω . A board was fabricated as shown in Figure E-8(A) to the dimensions specified above. Figures E-8(B) and E-8(C) show the incident and reflected waveforms observed with the TDR. The vertical scale is calibrated both in terms of the voltage and the reflection coefficient, ρ . Equation 3 can be rearranged to determine the characteristic impedance of the line:

$$Z_{\text{line}} = \left(\frac{1+\rho}{1-\rho} \right) \cdot Z_{\text{reference}} \quad (15)$$

where: Z_{line} = characteristic impedance of the line under test

and $Z_{\text{reference}}$ = impedance of the known line.

The 50Ω reference point is shown in Figure E-8(C). The mean level of the reflected waveform due to the line has a $\rho = +0.01$. Substituting values into equation 15 permits calculation of the line impedance:

$$Z_{\text{line}} = \left(\frac{1+0.01}{1-0.01} \right) \cdot 50 \text{ ohms} = 51 \text{ ohms} *$$

which agrees closely with the calculated value.

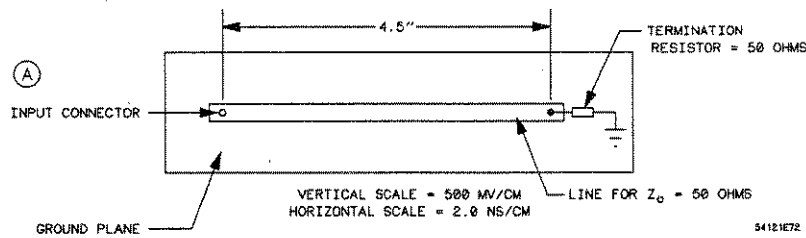

Figure E-8A. TDR Determination of Line Characteristic Impedance

* The HP 54120 Series digitizing oscilloscope with TDR, introduced since this article was written, internally calculates the line impedance and displays it on screen.

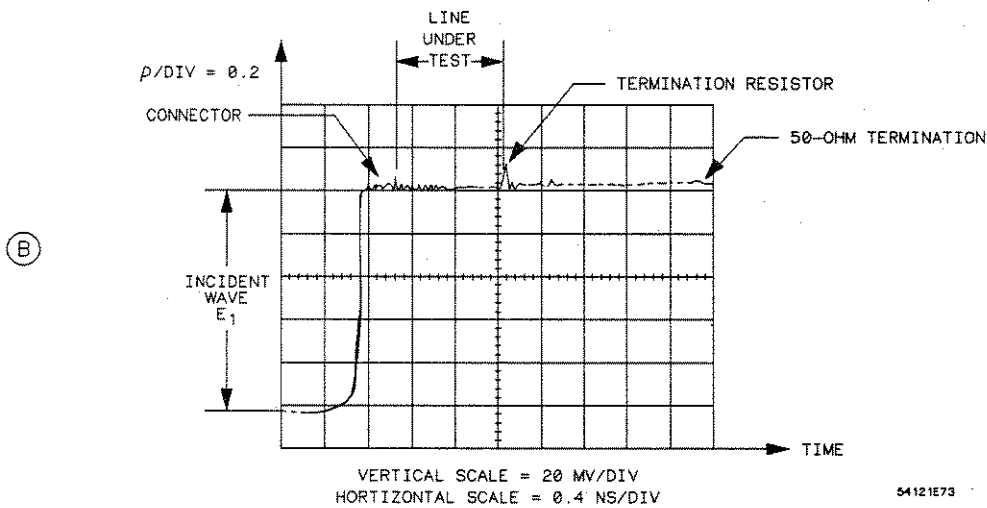

Figure E-8B and C. TDR Determination of Line Characteristic Impedance (Continued)

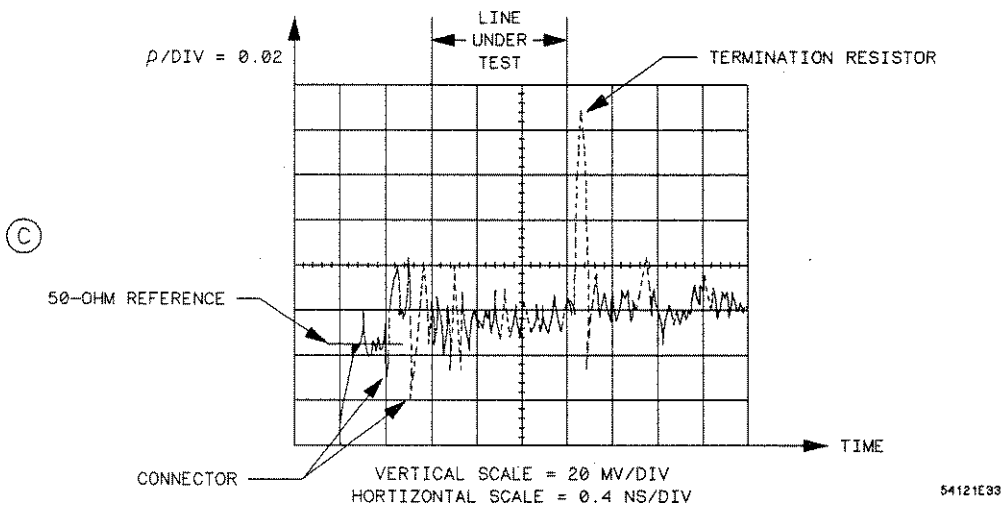

Figure E-8C. TDR Determination of Line Characteristic Impedance (Continued)

The reflected voltage due to the connector is ± 40 mV. The line reflects a voltage of ± 25 mV due to variations in the characteristic impedance of the line. The reflection of 88 mV shown for the termination resistor ($\rho = 0.088$) is due to the inductance of the resistor. It can be calculated that the inductance of the resistor is less than 0.9 nH.

In these experiments, the input waveform comes from a generator which has a risetime of 28 ps. There is some attenuation of the signal noticeable as it reaches the termination resistor ($t_r = 80$ ps at the load). When driving the line with a MECL III gate with a risetime of 1 ns, the reflection due to the inductance of the resistor would be much less (about 10 mV).

TDR Example 2: An equation can be derived to determine the maximum reflection voltage due to the inductance of the resistor leads. The circuit shown in Figure E-9 will be used in the derivation.

The reflection coefficient at the load is:

$$\rho_L(s) = \frac{Z_L - Z_0}{Z_L + Z_0} = \frac{(R_L + sL) - Z_0}{(R_L + sL) + Z_0} = \frac{s + \frac{R_L - Z_0}{L}}{s + \frac{R_L + Z_0}{L}} \quad (16)$$

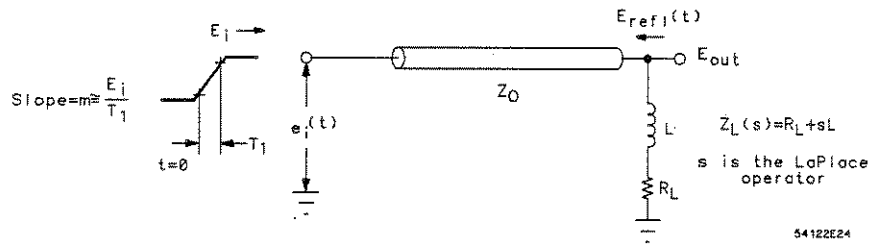

Figure E-9. Circuit for Determining the Maximum Reflected Voltage Due to the Inductance of the Resistor Leads

where s is the LaPlace operator for $j\omega$. The driving voltage will be represented as:

$$e_i(t) = mU(t) - m(t - T_1)U(t - T_1) \quad (17)$$

where $U(t)$ is a step function occurring at $t = 0$. Taking the LaPlace transform of equation 17 gives:

$$E_i(s) = \frac{m}{s^2} (1 - e^{-T_1 s}) \quad (18)$$

The reflected voltage at the load is then the product of the driving voltage and the reflection coefficient (both in the transformed plane):

$$E_{refl}(s) = E_i(s) \rho_L(s) = \frac{s + \frac{R_L - Z_0}{L}}{s^2 \left(s + \frac{R_L + Z_0}{L} \right)} \bullet m (1 - e^{-T_1 s}) \quad (19)$$

Taking the inverse LaPlace transform yields:

$$E_{refl}(t) = \left[\frac{2Z_0 L}{(R_L + Z_0)^2} + \left(\frac{R_L - Z_0}{R_L + Z_0} \right) t - \left(\frac{2Z_0 L}{(R_L + Z_0)^2} \right) e^{-\frac{(R_L + Z_0)t}{L}} \right] mU(t) - \left[\frac{2Z_0 L}{(R_L + Z_0)^2} + \left(\frac{R_L - Z_0}{R_L + Z_0} \right) (t - T_1) - \left(\frac{2Z_0 L}{(R_L + Z_0)^2} \right) e^{-\frac{(R_L + Z_0)(t - T_1)}{L}} \right] mU(t - T_1) \quad (20)$$

The maximum reflection voltage occurs at $t = T_1$. Then, for $R = Z_0$:

$$E_{\text{refl}}(t=T_1) = E_{\text{refl max}} = \frac{mL}{2Z_0} \left(1 - e^{-\frac{2Z_0}{L} T_1} \right) \quad (21)$$

This equation relates the maximum reflected voltage, which can be measured by TDR, and the inductance, which can then be calculated for the circuit of Figure E-9.

TDR Example 3: This example indicates how to measure the effect of resistor leads using the TDR. Figure E-10A shows the construction of a microstrip board used for determining the effects of a resistor with 1" lead lengths. The reflected voltage determined from the TDR measurement is 480 mV (see Figure E-10B). The risetime at the input to the line is 28 ps but it is lengthened to about 80 ps as the wavefront reaches the termination resistor.

The time, T_1 , associated with the slope of the input voltage rise at the terminating resistor can be approximated as:

$$T_1 \approx \frac{t_r}{0.80} = 100 \text{ ps} \quad (22)$$

The inductance can be computed by using equation 21, giving $L = 6 \text{ nH}$. Additional information can be obtained from the decay of the reflection shown in Figure E-10B. The decay lasts about 0.3 ns implying a time constant of about $0.3 \text{ ns} / 5 = 60 \text{ ps}$ (using 5 time constants as decay time). The calculated time constant for an inductance of 6 nH is:

$$L / (2Z_0) = 60 \text{ ps}$$

The two results agree closely.

When driving the line with a MECL III gate risetime = 1 ns the reflection would be only 50 mV. Most carbon resistor types will have less than 10 nH of inductance. This inductance gives a reflection 75 mV when the line is driven by a MECL III gate. Note that the reflection is positive, indicating that the noise immunity of a MECL gate connected at the load would be unchanged.

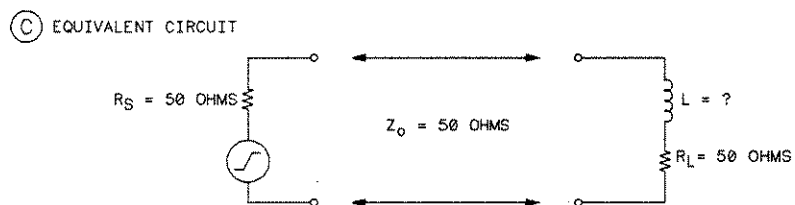
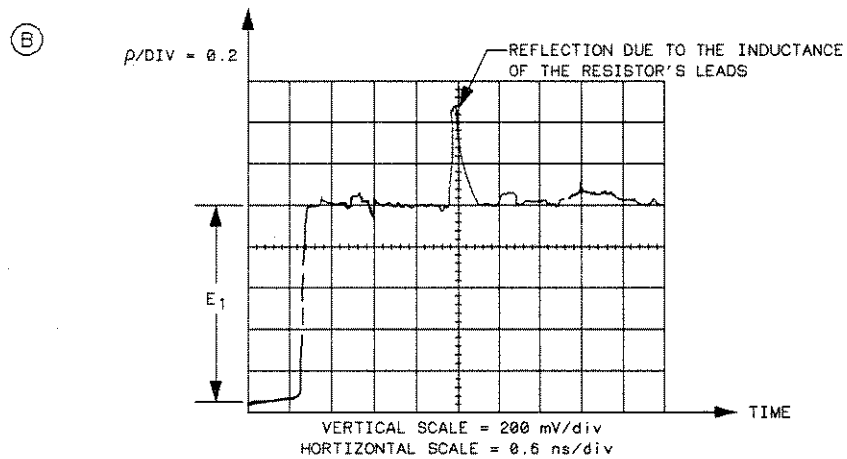
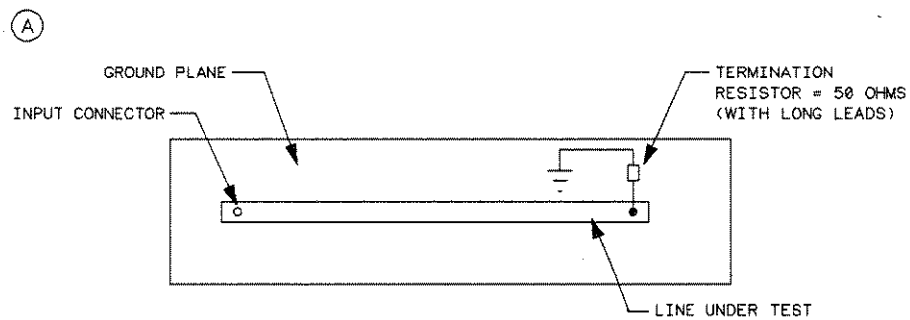

54121E34

Figure E-10. Effects Due to Termination Resistor Leads

TDR Example 4: Experiments have also been performed to determine the effects of a ground plane on the characteristic impedance of microstrip lines. Figure E-11 illustrates what happens when the ground plane width under the transmission line abruptly drops to the width of an active line. The TDR waveform shows that a 12% reflection occurs due to this discontinuity in the ground plane.

Using equation 15 the impedance of the 2-1/2 inch-long strip can be calculated as:

$$Z_{line} = \frac{1+0.12}{1-0.12} \cdot 50 = 60 \text{ ohms}$$

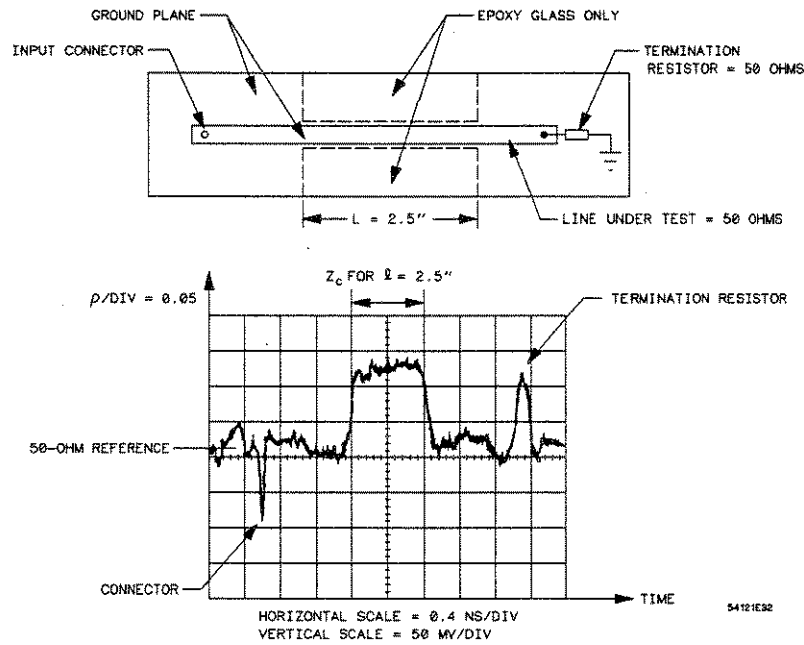

Figure E-11. Effects of Ground Plane Discontinuities.

Figure E-12 shows a curve that approximates the change in the characteristic impedance of the line for various ratios of ground plane width to active line width. Note that when the ground width is greater than 3 times the line width, the characteristic impedance is constant according to equation 14.

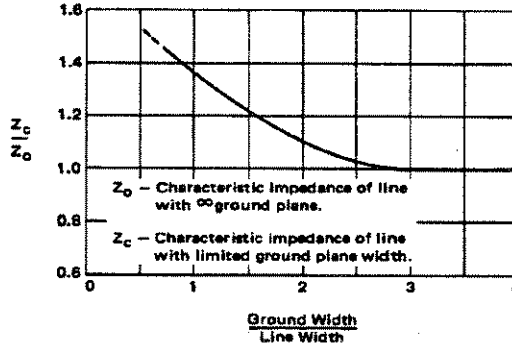

Figure E-12. Variation of Microstrip Impedance as a Function of Ground Width - Line Width

A related experiment was performed to find the reflection due to a ground plane near the active line, but not directly under it. The test configuration and test results are shown in Figure E-13. As indicated by the TDR measurement, the reflection is about 36%. Again using equation 15, the impedance of the 2-1/2 inch strip can be calculated:

The reason for the reflection is the change in the characteristic impedance along with the line resulting from the ground plane not being under part of the active line. In such a region, capacitance of the line to ground decreases while the inductance of the line increases, the net result being a higher characteristic impedance.

$$Z_{\text{line}} = \frac{1+0.36}{1-0.36} \cdot 50 = 106 \text{ ohms}$$

It must be remembered that the TDR input waveform has a risetime of 28 ps. Consequently, in a real logic circuit situation where perhaps, a MECL III gate with a 1 ns risetime is driving the line the reflection would actually be less than 27%, not 36% as in this example.* This can be determined by scaling the value of R found with the TDR waveshape in Figure E-13B, with a 1 ns risetime. When the length of the ground plane discontinuity is less than the distance travelled by the signal during its risetime, then the reflection coefficient can also be calculated as:

$$\rho' = \frac{2\ell t_{pd}}{t_r} \cdot \rho \quad \text{for } \frac{2\ell t_{pd}}{t_r} < 1 \quad (23)$$

where: t_{pd} = the propagation delay time of the line in ns / in.
 t_r = the risetime of the signal in ns
 ℓ = the length of the discontinuity in inches
 ρ = the reflection coefficient for $2\ell t_{pd} / t_r \geq 1$
 (in this case the value found with the TDR waveshape with $t_r = 28$ ns).

* With the HP 54120 Series of Digitizing Oscilloscopes with TDR, normalization allows the user to change the risetime of the measurement system to simulate actual circuit risetimes.

For a discontinuity in the ground plane of 2.5 inches length, a propagation delay of the line of 0.15 ns / in, and a MECL III gate with 1 ns risetime, the percent reflected voltage can be calculated. From Figure E-13B, ρ is found to be 0.36. Using equation 23

$$\rho' = \frac{2(0.36)(2.5)(0.15)}{(1)} = 0.27$$

Therefore, the reflection would be 27%. For a MECL 10K series gate with a risetime of 3.5 ns, the reflection would only be 7.7%, and a MECL 10KH gate with a rise time of 1.8 ns, the reflection would be 15%.

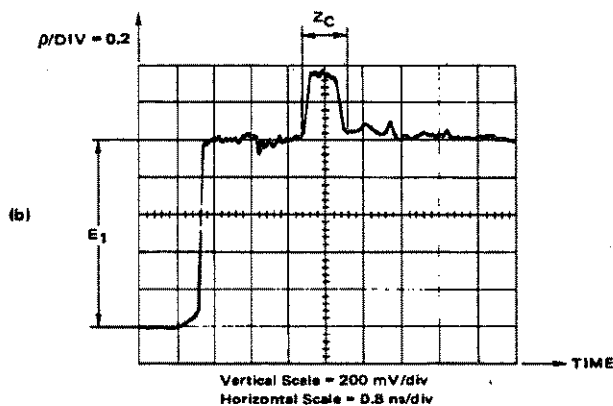
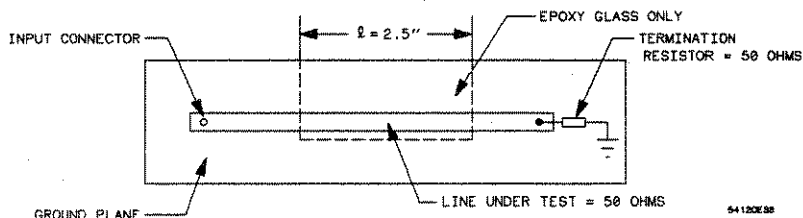

Figure E-13. Effects of Ground Plane Discontinuity

TDR Example 5: Another measurement was performed to observe the reflections due to the use of a hybrid divider. The construction of the microstrip board used is shown in the figure E-14. Note that the 50 Ω line branches out into two 100 Ω lines. A reflection of 4 percent is observed at point 2 where the junction occurs. Notice that the resistor exhibits a reflection of -8%, due to capacitance of the resistor.

Previously it was found that the 50 Ω resistor was inductive. The lower values of resistors ($< 75 \Omega$) exhibit inductance, while the higher values behave capacitively. Note that no mismatch appears due to crosstalk between the two 100 Ω branches, because of their wide separation.

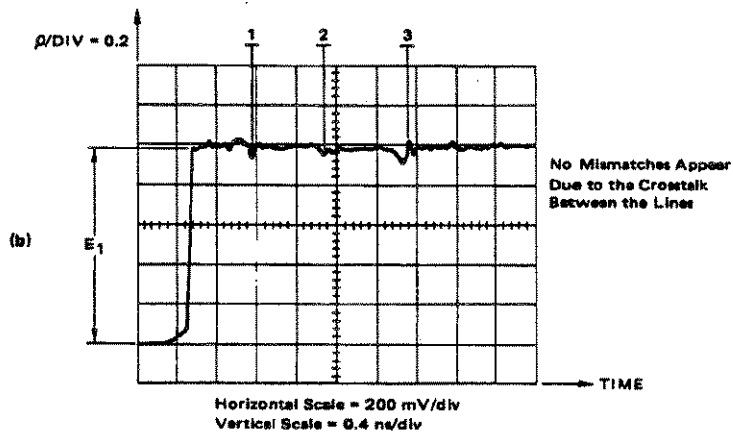
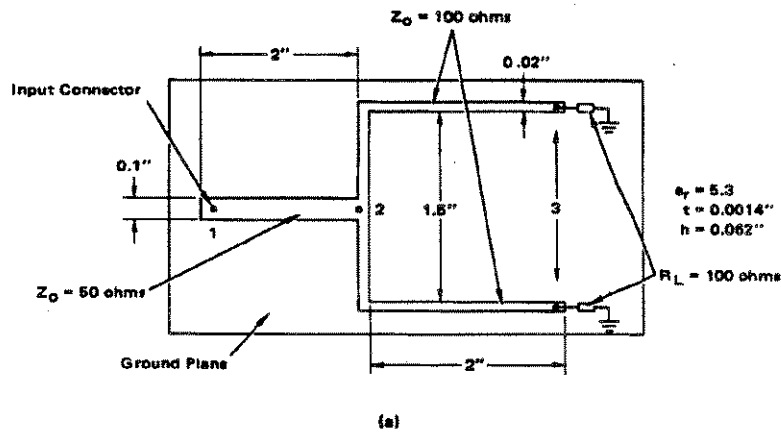

Figure E-14. Hybrid Divider

Figure E-15B shows the reflection due to the construction of Figure E-15A where the two 100 Ω lines have been brought close together. The reflection at point 2 is now equal to 8% arising from the cross coupling of the two lines.

Even mode or odd mode characteristic impedance (Z_{0e} or Z_{0o}) can be considered to exist in a circuit with crosstalk. One, Z_{0e} , is due to the strips being at the same potential and carrying equal currents in the same direction. The other, Z_{0o} , is due to the strips being at equal but opposite potentials and carrying equal currents in opposite directions. The backward crosstalk voltage, V_B , on a passive line is:

$$V_B = \left(\frac{Z_{0e} - Z_{0o}}{Z_{0e} + Z_{0o}} \right) E_1 \quad 24$$

where E_1 is the signal propagating down the active line. The backward crosstalk voltage shown in Figure E-15B at point 2 is equal to 8% of the incident voltage E_1 . Since both lines are active the crosstalk due to one active line is 4% of E_1 for a spacing of 80 mils.

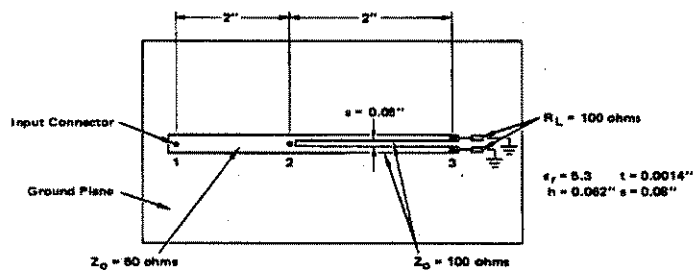

(a)

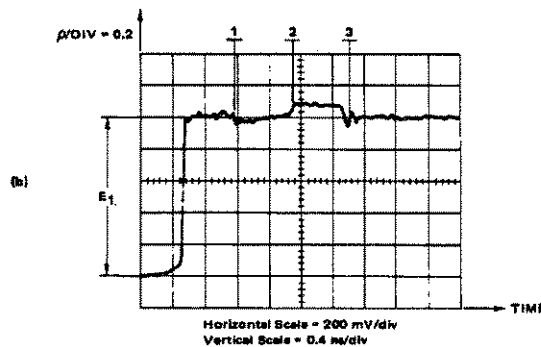

Figure E-15. Hybrid Divider with Crosstalk Problem

Crosstalk is not ordinarily a problem when using MECL III on microstrip or strip line circuit boards, when line spacings are greater than 30 mils. The mutual inductance and capacitance between two lines are used to determine the crosstalk coefficient. Forward crosstalk is normally much smaller than the backward crosstalk on microstrip lines except for very long lines (> 5 feet). Forward crosstalk does not exist at all on strip lines, since they are made with a homogeneous medium, so that the inductively and capacitively induced currents cancel.

The backward crosstalk coefficients for various types of microstrip lines on glass epoxy boards are shown in Figure E-16. The backward crosstalk coefficient is equal to:

$$K_B = \frac{1}{4t_{pd}} \left(\frac{L_M}{Z_0} + C_M Z_0 \right) \quad (25)$$

where L_M = the inductive coupling
 C_M = the capacitive coupling
 t_{pd} = the propagation delay of the line per unit length

TDR Example 6: The graph data in Figure E-16 will be used to determine the percent of crosstalk coupling for the circuit of Figure E-15. From the dimensions of the lines given in Figure E-15 (a), K_B is found to be 0.055 from the graph. This means that if one line (the active line) were driven with a signal, the other line (passive) would have a coupled signal of 5.5% of the amplitude on the active line, in a direction opposite to that of the driving signal. Since both 100 Ω lines are active simultaneously, the reflection observed on the TDR is twice as much, or 11%. From Figure E-15, the actual crosstalk can be seen to be about 8%.

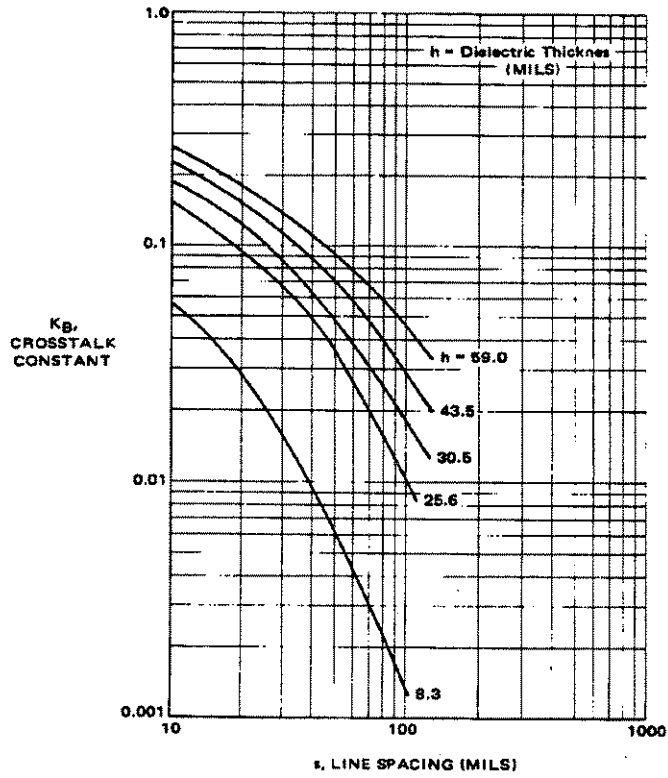

Figure E-16. Backward Crosstalk Coefficient for Microstrip Lines on Glass Epoxy Boards (G-10 Material)

In very high speed systems, the exact shape of a line can be important, if reflections are to be kept to a minimum. The arrangement shown in figure E-17A has been used to investigate the behavior of two different line shapes. For one line, corners are sharp. This permits the width of the line to be larger at corners than elsewhere. Figure E-17B shows that a -7.5% reflection occurs at point 6 due to the lowered characteristic impedance at the corner. For the other line, the corners are rounded to produce a constant line width. Figure E-17C shows that a constant line impedance exists for the second line. Note that an inductive reflection, as discussed before, does occur at the end of the line due to the inductance of the resistor. In conclusion, it is desirable to have smooth, rounded line edges and constant line widths when designing transmission lines for high speed systems. Resistor leads should be kept short to minimize termination inductance.

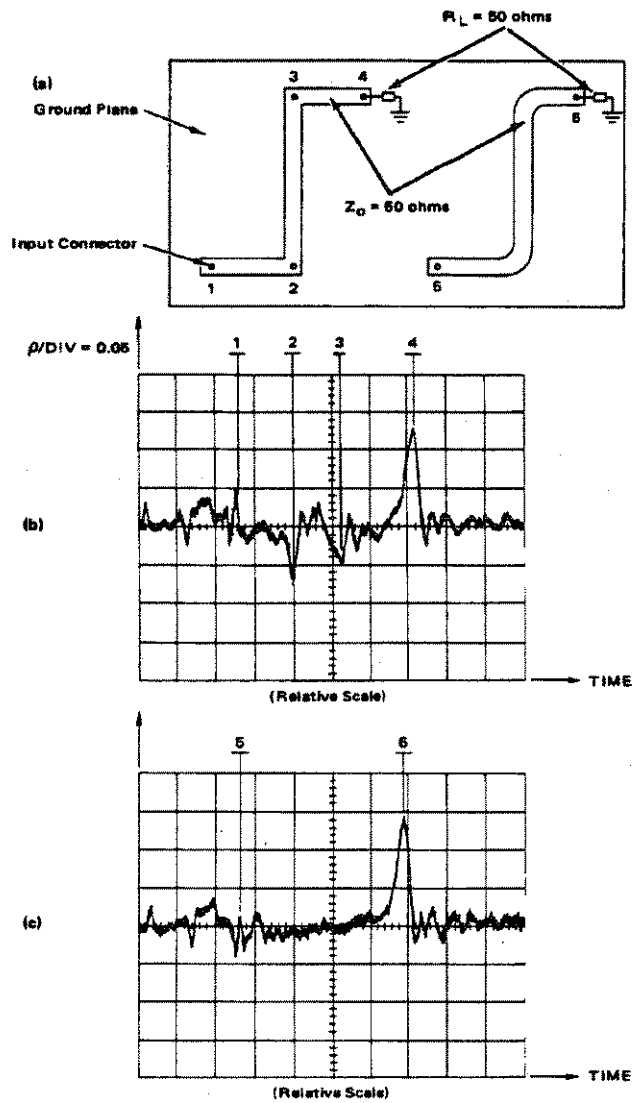

Figure E-17. Reflections Caused by Signal-Line Shape Variations

References

1. Kaupp, H. R., "Characteristics of Microstrip Transmission Lines", IEEE Transactions on Electronic Computers, Vol. EC-16 No. 2, April 1967, pp. 185-193.
2. Cohn, S. B., "Characteristic Impedance of the Shielded Strip Transmission Line", Transactions IRE, Vol. MTT-2, July 1954, pp 52-57
3. Springfield, W. K., "Designing Transmission Lines into Multilayer Circuit Boards". Electronics, November 1, 1965 pp. 90-96.
4. Skilling, H. H., "Electric Transmission Lines", New York McGraw-Hill, 1951.
5. DeFalco, J. A., "Reflections and Crosstalk in Logic Circuit Interconnections", IEEE Spectrum. July 1970, pp. 44-50.
6. Millman, J., and Taub, H., "Pulse, Digital and Switching Waveforms", New York, McGraw-Hill, 1965, pp.83-106
7. "Time Domain Reflectometry", Hewlett-Packard Application Note 62, 1964.
8. Botos, Bob, "Nanosecond Pulse Handling Techniques in I/C Interconnections", Motorola Application Note AN-270.
9. Schwarzmann, A., "Microstrip Plus Equations Adds Up to Fast Designs", Electronics, October 2, 1967, pp. 109-112
10. Catt, I., "Crosstalk (Noise) in Digital Systems". IEEE Transactions on Electronic Computers, Vol. EC-16, No. 6 December 1967, pp. 743-763.
11. Feller, A., H. R. Kaupp, J. J. Digiacom. "Crosstalk and Reflections in High-Speed Digital Systems". Proceedings, Fall Joint Computer Conference, 1965, pp. 511-525.
12. Cohn, S. B., "Shielded Coupled-Strip Transmission Line", IRE Transactions-Microwave Theory and Techniques, October 1955. pp. 29-38.
13. Gabbard, O. G., "High-Speed Digital Logic for Satellite Communications", Electro-Technology, April 1969, pp. 59-65.
14. Henschen, I. E. and E. M. Reyner II, "Adapting PC Connectors for Impedance Matching", Proceedings, NEPCON, 1970.

Index

A

accessories, list of 2-7
Acquire submenu 15-7
acquire a waveform 3-1...3-3
add operation 12-1...12-3
Add to Memory key (Waveform Save menu) 9-3
add waveforms algebraically 3-7
All key (Measure menu) 13-4...13-5
altitude, operating 2-2, 19-16
antistatic kit 2-2
applying power 2-4
PROBE ATTEN (attenuation) key (Channels menu) 5-3
PROBE ATTEN (attenuation) key (Trigger menu) 7-2
Auto Level Set key (Delta V) 10-5
automatic measurements 13-1...13-5, 19-7
Auto Pen key (Plot menu) 17-4
AUTOSCALE key (system key) 4-5
averaged display mode 8-2...8-4, 8-10, 19-7
averaged display mode exercise 8-9...8-11

B

background adjustment 2-6
bandwidth display mode 19-7
Bandwidth selection key (Display menu) 8-4
Bracewell transform 14-2
brightness adjustment 2-6

C

Cal menu (Utility menu) 18-1...18-9
Cal submenu (Network menu) 14-4...14-5
channel-to-channel skew 18-5...18-9
Channel select key (Channels menu) 5-2
Channel Skew Cal key (Utility menu) 18-5...18-9

Channel Skew Cals submenu (Utility menu) 18-5...18-7
Channels menu 5-1...5-3
Channels specifications 19-2
Channel Vertical Cal key (Utility menu) 18-4
CLEAR DISPLAY (system key) 4-2
Clear Memory key (Waveform Save menu) 9-3
coarse precision measurements 13-3
Color Cal menu (Utility menu) 18-2
color conventions 4-9
color display setup 2-6
Color Field key (Utility menu) 18-13
Color menu (Utility menu) 18-12...18-14
connector, HP-IB 2-4
connector, power 2-4
connectors, care and handling of B-1...B-17
connectors, interface cable 2-4
CRT menu (Utility menu) 18-2
Cursor key, Reflect submenu (Network menu) 14-17
Cursor key, Trans submenu (Network menu) 14-29

D

data display formats 19-8
dB versus voltage ratio 5-4
default color settings 18-14
Default Setting key (Utility menu) 18-12
degaussing 2-6
Delay key (Timebase menu) 6-2
Delay Reference key (Timebase menu) 6-2...6-3
Delta t menu 11-1...11-12
Delta V menu 10-1...10-11
device under test (DUT) 14-2
digitizing rate 19-15
dimensions 19-17
display colors 19-9

Display key (Waveform Save menu) 9-5
Display menu 8-1...8-12
Display Mode key (Display menu) 8-2
Display On/Off key (Channels menu) 5-2
Display On/Off key (Histogram menu) 15-8
Display On/Off key (Waveform Math menu) 12-3
Display Scaling key (Waveform Math menu) 12-4
Display Time key, persistence (Display menu) 8-3
distribution markers 15-11, 19-14
distribution, measuring 3-10...3-11
dual screen mode 9-5
DUT (device under test) 14-2

E

earth, grounding requirements 2-3
electrostatic discharge (ESD), avoiding damage by 2-2
ENTER keys 4-6
entry devices, the knob, key pad, & step keys 4-6...4-7
environment, operating 2-1...2-2, 19-16
EOI key (Utility menu) 18-11
errors, messages, & prompts A-1...A-5
ESD (electrostatic discharge) 2-2
exercises
 average display mode 8-9...8-12
 histogram 15-11...15-19
 infinite persistence 8-6...8-8
 normalizing 14-25...14-28
 only operator 12-8...12-9
 reflect (TDR) 14-21...14-24
 source-to-source time interval 11-9...11-12
 source-to-source voltage measurement 10-9...10-11
 time interval measurement 11-6...11-8
 transmission (TDT) 14-32...14-35
 voltage marker 10-6...10-8

waveform math 12-5...12-7

F

features, key 1-1
fine precision measurement 13-3
first operand key (Waveform Math menu) 12-3
Freerun Rate key (Timebase menu) 6-5
Freerun Triggered Sweep key (Timebase menu) 6-4
Freerun Triggered menu 6-1
front-panel organization 4-1
function selection 4-1
function selection keys 4-7...4-8
Function select key (Waveform Math menu) 12-3
functions, waveform math 12-2

G

graticule display mode 19-7
Graticule key (Display menu) 8-6
graticule selections 8-6
grounding, safety requirements 2-3

H

HF Reject key (Trigger menu) 7-3
HF Sensitivity key (Trigger menu) 7-3
histogram exercise 15-13...15-19
histogram measurements 15-3
Histogram menu 15-1...15-8
HP-IB menu 18-10...18-11
HSL color model 18-4
HUE key (Utility menu) 18-13
humidity, operating 2-2

I

increment/decrement keys 4-6
infinite persistence display mode 8-3
infinite persistence exercise 8-6...8-8
inverting a waveform 3-8
Invert operation 12-1...12-3

J

jitter, time 8-7, 8-11

K

knob, the 4-6

L

line switch 2-4

line voltage requirements 2-3

LOCAL (system key) 4-4

LOWER DIST LIMIT key (Histogram menu)
15-10

LUMINOSITY key (Utility menu) 18-12

M

main breaker 2-4

mains voltage requirement 2-3

manual, contents of 1-2

MARKER POSITION 1 key (Delta V menu)
10-3

MARKER POSITION 2 key (Delta V menu)
10-3

Maximum operator 12-1, 12-4

mean and standard deviation 19-14

Mean key (Histogram menu) 15-10

measurement aids 19-10

Measurement key (Measure menu) 13-2

Measure menu 13-1...13-5

memory, pixel 9-2

memory selection 9-2

memory, waveform 9-3

menu selection keys 4-7...4-8

messages A-1...A-5

Minimum operator 12-1...12-3

Min & Max Reflect key (Network menu) 14-20

N

Network menu 14-1...14-20, 14-29...14-32

normalization 14-2

NORMALIZED RISETIME key, (Network menu) 14-16...14-17, 14-28...14-29

Normalize to Mem 1 key, reflection measurement, (Network menu) 14-17

Normalize to Mem 2 key, transmission measurement (Network menu) 14-29

Normalizing exercise 14-25...14-28

NUMBER OF AVERAGES (display menu)
8-4

NUMBER OF SAMPLES key (Histogram menu) 15-6...15-7

O

OFFSET key, vertical position (Channels menu) 5-3

OFFSET limits 5-3

Only operation 12-1, 12-3

Only operator exercise 12-8...12-9

operand, waveform math 12-3, 12-4

operating characteristics 19-7...19-18

Channels 19-7

Display 19-8

Horizontal 19-5

Timebase 19-5

Trigger 19-6

Vertical 19-2

operating environment 2-2

operation select key (Waveform Math menu)
12-3

P

Pen Speed key (Plot menu) 17-5

persistence display mode 8-2...8-3, 19-6

pixel memories 9-3

plot a waveform 3-6

Plot menu 17-1...17-5

Plot menu options 17-4

plotting, setting up for 17-3

power, applying 2-3

power module 2-4

power requirements 2-3, 19-17

precision connectors, care and handling of
B-1...B-17
Precise Edge Find key (Delta t menu) 11-5
Precision key (Measure menu) 13-3
Preset Levels key (Delta V menu) 10-4...10-5
Preset Reflect Channel key (Network menu)
14-16
Print menu 16-1...16-4
Print menu options 16-3...16-4
printing, setting up for 16-3
programmability 19-9
prompts A-1...A-5
Prop Delay and Gain key (Network menu)
14-32
pulse measurement, making a 3-9

Q

quad screen mode 9-5
quantified measurements 15-2

R

rear panel 2-4
RECALL SETUP (SAVE/RECALL front
panel setup) key 4-3
Reflect Cal key (Network menu) 14-8...14-11
Reflect Channel Is key (Network menu) 14-6
reflect (TDR) exercise 14-21...14-24
Reflect submenu (Network menu) 14-17...14-20
reflection measurements 19-11...19-13
Results submenu (Histogram menu) 15-10
Rho, instantaneous percent reflection 14-19
RMS voltage 13-5
RUN (system key) 4-3

S

SATURATION key (Utility menu) 18-12
SAVE/RECALL front panel setup key 4-3
saving a waveform 3-5
Screen key (Display menu) 8-5
second operand key (Waveform Math menu)
12-4

Sigma key, standard deviation, (Histogram
menu) 15-12
single screen mode 9-5
Slope key (Trigger menu) 7-2
SMA connectors B-1...B-17
Source for Store key (Waveform Save menu)
9-5...9-6
Source Is Channel 1/2/3/4 key (Histogram
menu) 15-6
source-to-source time interval exercise
11-9...11-12
source-to-source voltage measurement exercise
10-9...10-11
specifications Channels 19-2
Horizontal 19-5
TDR System 19-4
Timebase 19-5
Vertical 19-2
Start Acquiring key (Histogram menu) 15-7
START MARKER 11-2
START ON EDGE key (Delta t menu)
11-3...11-4
Step & Chan 1/3 key (Network menu) 14-18
Step & Chan 4 key (Network menu) 14-30
Stop Acquiring key (Histogram menu) 15-7
STOP (system key) 4-3
STOP MARKER 11-2
STOP ON EDGE key (Delta t menu)
11-3...11-4
Store key (Waveform Save menu) 9-6
subtracting waveforms algebraically 3-7
subtract operation 12-1, 12-3
system control keys 4-1

T

Talk/Listen mode 18-10
Talk Only mode 18-10
TDR exercise 14-21...14-24
TDR measurement, making a 3-10...3-11
14-7...14-9
TDR (time domain reflection) 14-2

TDT (time domain transmission) 14-2
temperature, operating 2-2, 19-16
Test menu (Utility menu) 18-2
Timebase menu 6-1...6-5
TIME/DIV (Utility menu) 18-5
TIME/DIV key (Timebase menu) 6-2
time histogram exercise 15-13...15-19
time histograms 19-14
time interval measurement exercise 11-6...11-8
time jitter exercise 8-6...8-8
time markers 11-1...11-2, 19-7
time measurement, making a 3-4...3-5
Time/Voltage Histogram key 15-5
Trans Cal key (Network menu) 14-11
Trans submenu (Network menu) 14-29...14-32
transmission measurements 14-3, 19-10...19-11
transmission (TDT) exercise 14-32...14-35
transmission (TDT) measurement 3-10...3-11
14-26
TRIGGER LEVEL key 7-2
Trigger menu 7-1...7-3
triggered sweep menu (timebase menu) 6-1

U

umbilical cable 2-4
UPPER DIST LIMIT key 15-9
Utility menu 18-1...18-15

V

VARIABLE LEVELS key 10-4
variable persistence mode 8-3
Velocity/Dielectric Constant key (Network menu) 14-12...14-15
vertical sensitivity (VOLTS/DIV) 5-2
Versus operation 12-1...12-2, 12-4
vibration, operating 19-16
voltage histograms 19-14
voltage marker exercise 10-6...10-8
voltage markers 10-2...10-5, 11-4, 19-7
voltage measurement, making a 3-4
voltage, RMS 13-5

VOLTS/DIV key (Channels menu) 5-2
voltage ratio versus dB 5-4

W

waveform
acquiring 3-1...3-2
adding 3-7
inverting 3-8
measuring distribution of 3-11
plotting 3-6
printing 3-6
saving 3-5
subtracting 3-7
waveform math exercise 12-5...12-7
Waveform Math menu 12-1...12-7
waveform memories 9-4
waveform memory selection 9-2
WAVEFORM/PIXEL MEMORY key
(Waveform Save menu) 9-2
Waveform Save menu 9-1...9-6
weight 19-17
WINDOW MARKER 1 key (Histogram menu)
15-6
WINDOW MARKER 2 key (Histogram menu)
15-6
Window submenu (Histogram menu)
15-5...15-6
wrist strap (antistatic) 2-2

Z

Z, impedance 14-20
0%-100% Set At Limits key (Histogram menu)
15-11

